

Tube coupling technology catalogue

- Tube couplings
- Flange couplings
- Hydraulic valves
- Pre-assembly devices
- Tools and accessories

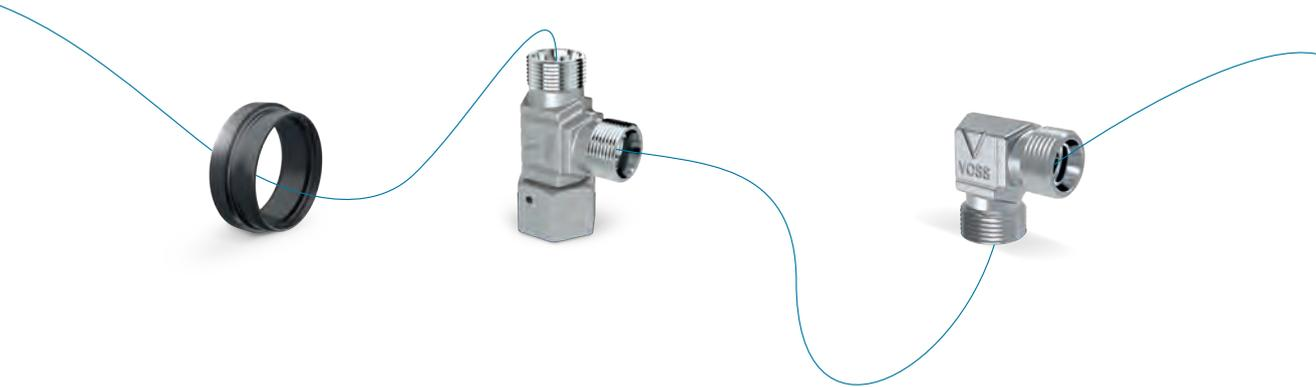

VOSS Fluid GmbH sales organisation

Germany

VOSS Fluid GmbH
P.O. Box 15 40
51679 Wipperfürth
Lüdenscheider Straße 52–54
51688 Wipperfürth
Tel. +49 2267 63-0
Fax +49 2267 63-5621
+49 2267 63-5622
+49 2267 63-5623
fluid@voss.net
www.voss.net

Brazil

VOSS Automotive Ltda
Av. Alvares Cabral, 1087
CEP 09980-160
Diadema – São Paulo
Tel. +55 11 40539500
Fax +55 11 40539524
fluid.br@voss.net
www.voss.com.br

China

Tel. +86 510 66902370
fluidchina@voss.net

France

VOSS Distribution S.a.r.l.
57 Route de Crécy
28500 Vernouillet
Tel. +33 237 380190
Fax +33 237 468914
info@fr.voss.net
www.fr.voss.net

Italy

VOSS S.r.l.
Via de Gasperi 31
20020 Lainate (MI)
Tel. +39 02 93796352
Fax +39 02 9373577
info@it.voss.net
www.it.voss.net

Poland

Tel. +48 515 312750
fluid.pl@voss.net

Sweden

Tel. +46 703826800
fluid.se@voss.net

Spain

VOSS S.A.
Paseo del Comercio, 90
Apartado Correos, 1014
08203 Sabadell
Tel. +34 93 7106262
Fax +34 93 7116357
info@es.voss.net
www.es.voss.net

USA

VOSS Automotive, Inc.
4640 Hillegas Road
Fort Wayne, IN 46818
Tel. +1 260 3732277
Fax +1 260 3732299
info@us.voss.net
www.vossusa.com

Dealers world-wide

Please request the latest
list of dealers from our
Wipperfürth sales office.

To ensure that VOSS products perform reliably, it is essential to follow the relevant operating and assembly instructions and to adhere to the latest standards and regulations for general mechanical engineering. Make sure to use up-to-date versions at all times.

Subject to errors, including printing errors, and technical modifications.

This catalog edition supersedes all previously published technical documents, catalogs, assembly instructions etc. All preceding documents therefore become invalid with immediate effect.

© Copyright 2015, VOSS Fluid GmbH

Content	Chapter
General Information	1
Overview of 24° tube couplings	2
Tube connecting parts, 24° connecting pieces and individual parts / accessories	3
Flange couplings / ZAKO / ZAKO LP	4
Hydraulic valves	5
Pre-assembly devices and tools	6
Assembly instructions	7
General technical notes	8
Services	9

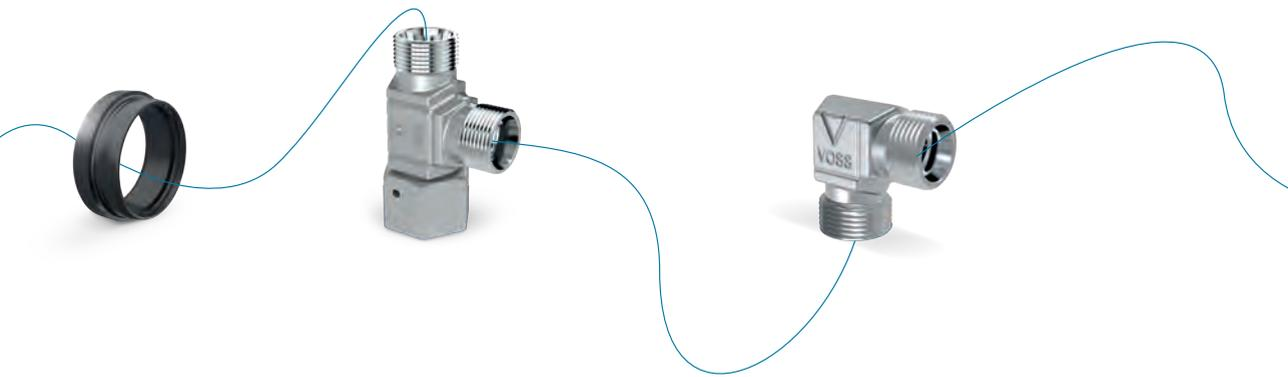

General information

passionately
connected.

The company

VOSS is partner to vehicle manufacturing and mechanical engineering companies, providing tubing and connection technology for fluid systems.

Thanks to its strong customer focus, its innovations and outstanding quality, the company – founded in 1931 – has developed into an international corporate group. VOSS Holding is the parent organization under which VOSS Automotive GmbH, VOSS Fluid GmbH and 11 foreign subsidiaries are grouped.

With production facilities in Austria and abroad and sales companies in Europe and overseas, VOSS is one of the top suppliers of fluid system components – “VOSS Automotive” serving the vehicle engineering and “VOSS Fluid” for the mechanical engineering sectors.

VOSS’s product range includes connecting elements, ready-to-install tubing, valves and other components for use in pneumatic, hydraulic, fuel and air-conditioning systems.

VOSS, as a development partner and system provider offering a comprehensive product range, is committed to active participation in ongoing decision-making processes in the fluid engineering industry.

Company headquarters: Factory and administration in Wipperfürth



Machine components for connection and coupling technology

A full product range plus top quality: this is the principle VOSS follows to produce one of the world's most comprehensive product ranges for tube coupling systems. The entire product spectrum is available as a catalogue.

The VOSS programme includes cutting ring, soft seal and flared couplings, tube forming systems, flange couplings and a wide range of accessories. VOSS puts special emphasis on the development of customized system solutions covering the entire task range – from initial planning, engineering production, assembly and installation, right up to special logistics services.

VOSS Fluid also offers convincing value-added services and improvement proposals that take purchasing costs, assembly and installation effort, durability of leak-tightness and long-term corrosion protection into account.

As a standard feature, all products in the extensive product range have optimum corrosion protection, provided by a top-quality VOSS coat surface finish containing no hexavalent chromium. Extensive salt-spray tests conducted in accordance with DIN EN ISO 9227 have shown that corrosion resistance is retained even after 1,000 hours of practical conditions, i.e. after handling and assembly.

VOSS Fluid's uncompromising quality policy and application-specific quality objectives, well documented in all certificates and approvals required by relevant trade associations and professional bodies, have ensured the company a top place in all its established markets.

With a wide range of system stocks all around the world and a global network of authorized trade dealers, VOSS ensures maximum product availability and highly economical delivery systems. These range from KANBAN full service right up to full optimization of the customer's supply chain.

VOSS Fluid also offers a wide range of special services, including regular training sessions and application-related publications. The internal and external logistics of the entire VOSS corporate group bring customers considerable cost advantages, allowing "just-in-time" production without having to maintain large stocks of their own.



VOSS corporate environmental policy

- 1** The management of the VOSS corporate group considers environmental protection to be an important part of business management and the basis of long-lasting company success.
- 2** VOSS employees are integrated at all levels into the group's efforts to protect and reduce the burden on the environment on a permanent basis, and their awareness for the environment is encouraged by training and other activities.
- 3** VOSS evaluates the impact of all new developments (both products and processes) on the environment with the aim of keeping this impact to a minimum.
- 4** The impact of activities on the local environment are regularly monitored and evaluated.
- 5** Where it is impossible to avoid negative impact on the environment, one of the company's explicit objectives is to continuously reduce this impact.
- 6** In order to put this policy into practice, defined procedures and specifications regulating the relevant technical and organizational procedures are in place within the company.
- 7** Working in close cooperation with authorities and customers, VOSS constantly determines and evaluates existing environmental protection requirements. This forms the basis for all our activities to constantly reduce existing environmental burdens and comply with statutory regulations.
- 8** The public, as well as any other interested persons and organizations can obtain information on our environment-related activities at any time.
- 9** VOSS encourages its contractual partners to apply the same standards as VOSS itself does.
- 10** Energy efficiency is a major consideration when acquiring plant, equipment and services.
- 11** We are constantly improving our energy balance by implementing dedicated measures.



Overview of 24° tube couplings

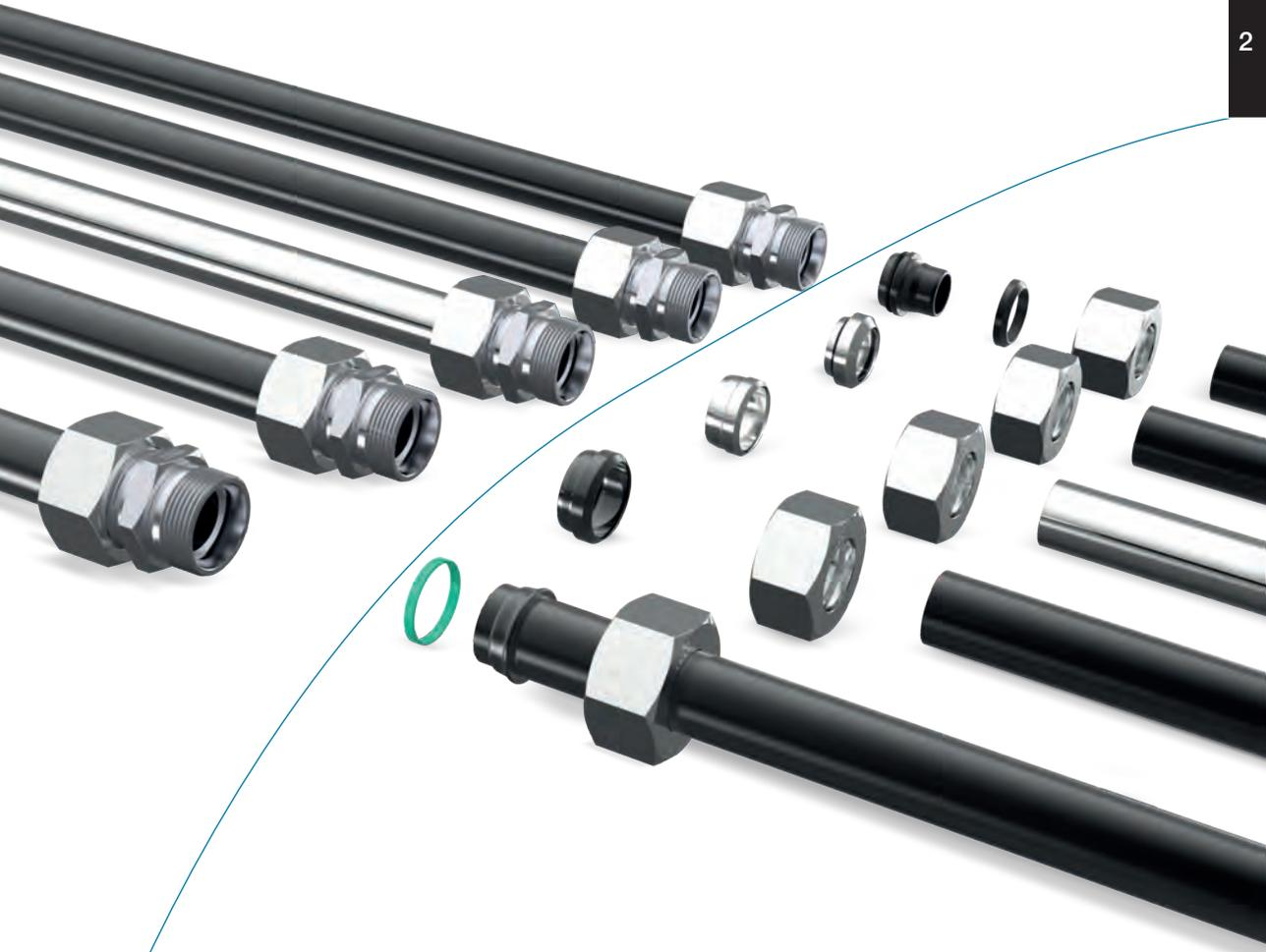

Content	Type/Page
---------	-----------

The right connections for all applications

P.11

The Complete Range of VOSS Couplings

P.12

24° taper coupling range with a wide variety of system solutions

P.14

The main advantages of 24° couplings

P.15

How to obtain a permanently leak-free connection system

P.16

Requirements / System features

P.17

VOSSRing^M cutting ring couplings

P.19

Content	Type/Page
---------	-----------

ES-4 cutting ring couplings	P.25
-----------------------------	------

2SVA / ES-4VA cutting ring couplings	P.29
--------------------------------------	------

VOSSForm ^{SQR} / VOSSForm ^{SQRVA} tube couplings	P.31
--	------

BV-10 flared couplings	P.35
------------------------	------

24° taper couplings / welding couplings	P.39
---	------

Customer designed products – individualized customer solutions	P.43
--	------

The right connections for all applications

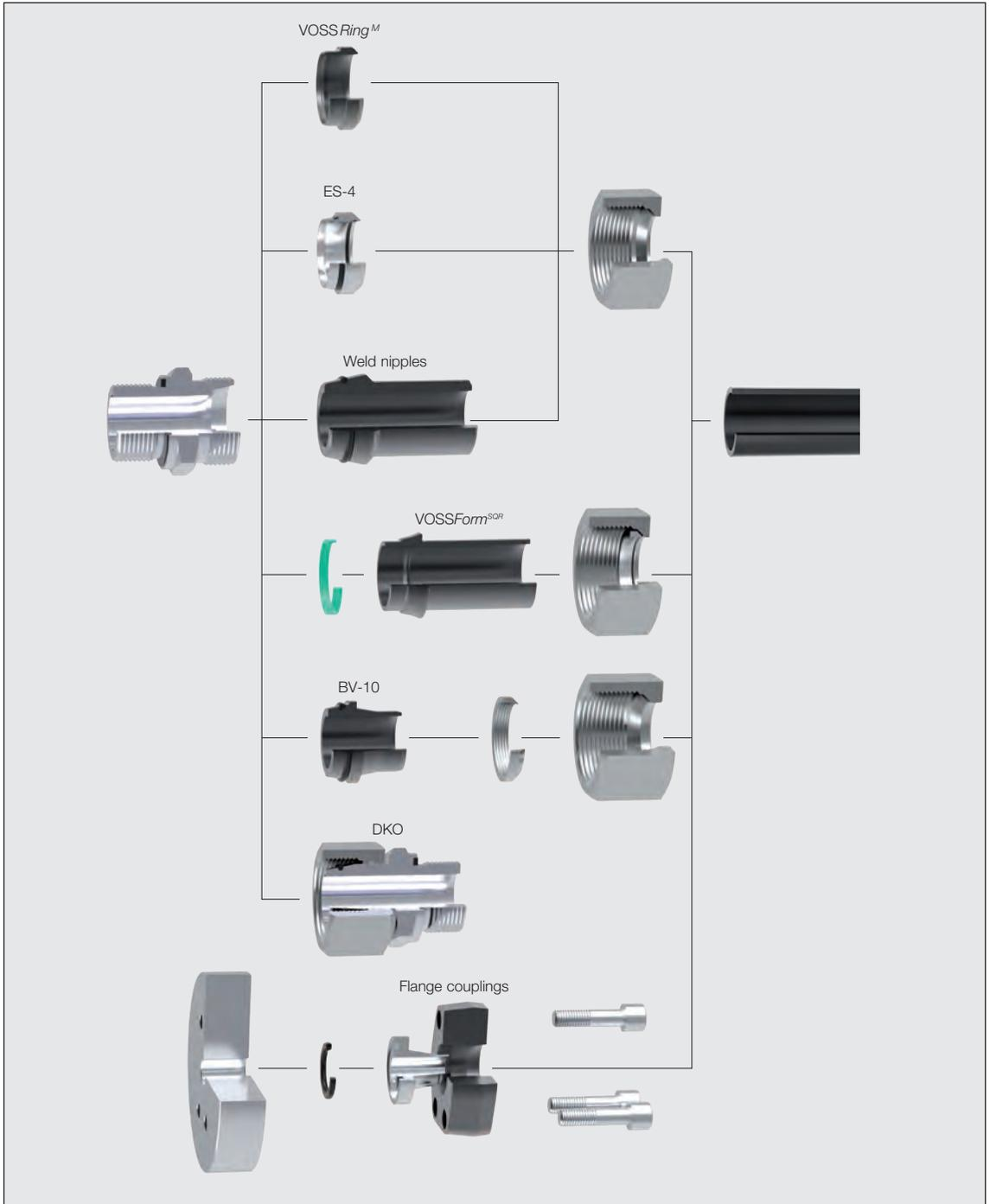

The complete range of VOSS couplings

Connection components

<p>VOSSRing^M</p>  <p>P. 58 24-VRM-...</p>	<p>ES-4 cutting rings</p>  <p>P. 60 24-ES4-...</p>	<p>2SVA cutting rings</p>  <p>P. 59 24-2S-...-SST</p>	<p>ES-4VA cutting rings</p>  <p>P. 60 24-ES4-...-SST</p>	<p>Union nuts</p>  <p>P. 62 24-N-...</p>
--	---	--	---	---

<p>SQR-Function nuts and seals</p>  <p>P. 64 24-SQRNMS-...</p>	<p>SQRVA-Function nuts and seals</p>  <p>P. 64 24-SQRNMS-...-SST</p>
--	---

<p>BV-10 Flared cones</p>  <p>P. 66 24-BV10C-...</p>	<p>BV-10 Clamping rings</p>  <p>P. 68 24-BV10R-...</p>	<p>BV-10 Union nuts</p>  <p>P. 69 24-BV10N-...</p>
---	---	---

Male stud couplings

<p>metric/imperial/NPT tapered</p>  <p>P. 80 24-SDS-...</p>	<p>metric/imperial, parallel, seal edge</p>  <p>P. 85 24-SDS-...</p>	<p>metric/imperial, parallel, PEFLEX</p>  <p>P. 91 24-SDS-...</p>	<p>UN/UNF, O-ring</p>  <p>P. 97 24-SDS-...</p>	<p>Straight</p>  <p>P. 114 24-S-...</p>	<p>Reducing couplings</p>  <p>P. 115 24-S-...-...</p>	<p>Elbow</p>  <p>P. 117 24-E-...</p>
<p>metric, parallel, ISO 6149, O-Ring</p>  <p>P. 100 24-SDS-...</p>	<p>Elbow, metric/imperial, tapered</p>  <p>P. 104 24-SDE-...</p>	<p>L, metric/imperial, tapered</p>  <p>P. 108 24-SDL-...</p>	<p>T, metric/imperial, tapered</p>  <p>P. 110 24-SDT-...</p>	<p>T</p>  <p>P. 118 24-T-...</p>	<p>T-Reduction</p>  <p>P. 119 24-T-...-...-...</p>	<p>Cross</p>  <p>P. 122 24-K-...</p>

Connecting adapters

Adjustable couplings with tube socket

<p>Elbow</p>  <p>P. 146 24-SWE-...</p>	<p>T</p>  <p>P. 147 24-SWT-...</p>	<p>L</p>  <p>P. 148 24-SWL-...</p>	<p>Stud standpipe adapters, metric/imperial, parallel, seal edge</p>  <p>P. 149 24-SWSDS-...</p>	<p>Stud standpipe adapters, metric/imperial, parallel, PEFLEX</p>  <p>P. 151 24-SWSDS-...</p>	<p>Stud standpipe adapters, NPT</p>  <p>P. 153 24-SWSDS-...</p>	<p>Reducing inserts</p>  <p>P. 154 24-SWS-...-...</p>
--	---	---	---	--	--	--

24° Taper couplings

<p>Straight, DKO</p>  <p>P. 160 24-SW2OS-...</p>	<p>Elbow, DKO</p>  <p>P. 166 24-SWOE-...</p>	<p>45°, DKO</p>  <p>P. 167 24-SWOE45-...</p>	<p>T, DKO</p>  <p>P. 168 24-SWOT-...</p>	<p>L, DKO</p>  <p>P. 169 24-SWOL-...</p>	<p>Stud standpipe adapters, DKO, metric/imperial, parallel, PEFLEX</p>  <p>P. 170 24-SWOSDS-...</p>	<p>Reducing couplings, DKO</p>  <p>P. 173 24-SWOS-...-...</p>
--	---	---	---	---	--	--

Banjo and rotary couplings

<p>metric/imperial parallel, Standard design</p>  <p>P. 128 24-BSE-...</p>	<p>metric/imperial, parallel, Low-restrictive design</p>  <p>P. 132 24-BEE-...</p>	<p>metric/imperial, parallel, high pressure</p>  <p>P. 136 24-BCE-...</p>	<p>metric/imperial, parallel, rotary coupling</p>  <p>P. 142 24-PCE-...</p>	<p>Straight welding bosses</p>  <p>P. 188 24-WDS-...</p>	<p>Welding bulkhead couplings</p>  <p>P. 189 24-WDBHS-...</p>	<p>Welding nipples with O-ring seal</p>  <p>P. 190 24-WDNPSO-...</p>
---	---	--	--	---	---	---

Bulkhead couplings

Adjustable couplings with lock nut

<p>Straight</p>  <p>P. 124 24-BHSLN-...</p>	<p>Elbow</p>  <p>P. 125 24-BHELN-...</p>	<p>Elbow, metric/imperial, parallel</p>  <p>P. 180 24-SDAE-...</p>	<p>Elbow, metric, parallel, ISO 6149, O-ring</p>  <p>P. 182 24-SDAE-...</p>	<p>45°, metric, parallel, ISO 6149, O-ring</p>  <p>P. 183 24-SDAE45-...</p>	<p>L, metric, parallel, ISO 6149, O-ring</p>  <p>P. 184 24-SDAL-...</p>	<p>T, metric, parallel, ISO 6149, O-ring</p>  <p>P. 185 24-SDAT-...</p>
--	---	---	--	--	---	--

Female stud and gauge couplings

Flange couplings

<p>Straight female stud couplings, metric/imperial</p>  <p>P. 194 24-S-...</p>	<p>Gauge couplings, standard couplings</p>  <p>P. 197 24-PGS-...</p>	<p>Straight, square</p>  <p>P. 250 24-FSO-...-HC-...-...</p>	<p>Elbow, square</p>  <p>P. 251 24-FEO-...-HC-...-...</p>	<p>ZAKO tube-to-port flange couplings, SAE, 3000/6000 psi</p>  <p>P. 268 Z-TPO-...</p>	<p>ZAKO tube-to-tube flange couplings, SAE, 3000/6000 psi</p>  <p>P. 272 Z-TTO-...</p>	<p>ZAKO tube-to-port flange couplings, square</p>  <p>P. 276 Z-TPO-...-HC-...-...</p>
<p>Gauge couplings, male version</p>  <p>P. 198 24-SWPGS-...</p>	<p>Gauge couplings, DKO</p>  <p>P. 199 24-SWOPGS-...</p>	<p>Straight, SAE</p>  <p>P. 254 24-FSO-...</p>	<p>Elbow, SAE</p>  <p>P. 256 24-FEO-...</p>	<p>ZAKO tube-to-tube flange couplings, square</p>  <p>P. 278 Z-TTO-...-HC-...-...</p>	<p>ZAKO LP tube-to-port flange couplings, SAE</p>  <p>P. 290 Z-TPO-LP-...</p>	<p>ZAKO LP tube-to-tube flange couplings, SAE</p>  <p>P. 291 Z-TTO-LP-...</p>

Component parts and accessories for couplings

<p>Thread reducing couplings, straight</p>  <p>P. 200 GP-SDS-...</p>	<p>Blanking screws</p>  <p>P. 205 GP-PLIH-...</p>	<p>Blanking plugs</p>  <p>P. 208 24-PLOC-...</p>	<p>Tube blanking screws</p>  <p>P. 211 24-TBS-...</p>	<p>Reinforcing sleeves</p>  <p>P. 213 24-RS-...</p>
---	--	---	--	--

Hydraulic-Valves

<p>Non-return valves tube coupling on both ends</p>  <p>P. 313 24-VNRO-...</p>	<p>Non-return valves female thread</p>  <p>P. 314 GP-VNROI-...</p>	<p>Non-return valves screw in thread</p>  <p>P. 316 24-VNROPT-...</p>	<p>Non-return valves screw in thread</p>  <p>P. 318 24-VNROTP-...</p>	<p>Non-return valves plug-in cartridges</p>  <p>P. 325 GP-VNRCO-...</p>	<p>Shuttle valves ball seat/soft sealing</p>  <p>P. 327 24-VST-...</p>
---	---	--	--	--	--

24° coupling range with a wide variety of system solutions

VOSS 24° DIN tube couplings as specified in ISO 8434-1 and DIN 2353 are among the most widespread hydraulic coupling systems worldwide. Thanks to their tremendous advantages, this type of tube connection has become firmly established, particularly in Europe, Asia and South America.

Product details

This product range consists of a low and a high series (L and S) which differ with regard to pressure ratings and dimensions.

All stated nominal pressure ratings (PN) are designed for a four-fold safety factor.

For the tube connection end, various coupling systems can be adapted to suit the particular application, with the 24° conical bore serving as the sealing surface.

The broad range of VOSS Fluid screw couplings covers a wide variety of shapes, such as elbow, T and L couplings. These are available in a variety of designs, such as connection couplings, bulkhead couplings, stud couplings and stud couplings with adjustable flow direction. To supplement this range, VOSS also offers diverse special designs such as adapters, gauge couplings, blanking plugs and non-return valves.

A wide variety of thread and seal types conforming to international standards can be supplied for the screw connections.

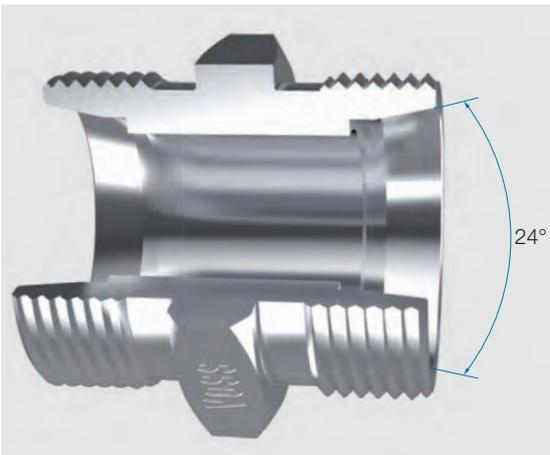

The main advantages of 24° couplings

- This type of coupling is leak-tight and can resist alternating bending moments and pressure transients as well as preventing tubes from tearing out of the connection.
- The connection can be taken apart and re-assembled as often as desired. This is particularly important for servicing and maintenance.
- Various tube connection systems can be combined with the 24° coupling bodies to suit the application. This makes it possible to modify a system which normally uses purely metallic sealing into one with additional soft sealing functions.
- These tube couplings provide maximum leak-tightness even when subjected to very high system pressures (up to 800 bar), although they have compact external dimensions and are easy to assemble and install.
- The permitted system pressures of the couplings are specified for a safety factor of 4. This ensures adequate reserve strength in case of overloads.
- A wide range of designs is available, making it possible to apply a modular design concept when selecting components. In this way special couplings and unnecessary tube loops in installation spaces can be avoided. A wide variety of metric and imperial threads and seal types is also available for the male threaded variants.
- The 24° system is a universal standard and is therefore in widespread use, particularly in Europe, Asia and South America. Hose couplings can also be connected easily to this system.
- These tube connections are easy to assemble.
- Under normal conditions, subsequent re-tightening is not necessary when 24° coupling systems are used. The coupling cannot come apart by itself.
- A “lightweight” series is available for lower system pressures up to 500 bar. These couplings cost less, save weight, occupy less space and permit higher flow rates.
- The optimum tube clamping achieved by the 24° coupling system keeps the connection flexible enough to absorb piping system vibration. As opposed to this, permanent connections are rigid and often tend to tear apart.
- All VOSS couplings are supplied with a VOSS coat protective finish as a standard feature. This provides the best possible corrosion protection.
- Many independent certification bodies have confirmed the functional characteristics of the entire coupling system.

How to obtain a permanently leak-free connection system

Couplings that are leak-tight at all times improve the cost-effectiveness of your products and improve their image. The diversity of VOSS coupling systems and the wide range of types available offer a suitable solution for almost any application.

Taking the respective purpose and application into account, we offer the following recommendations concerning design and selection of the correct coupling system.

Pay attention to the essentials

All main parameters – such as pressure, volume flow rate, ambient temperature, external influences, standard and/or statutory requirements as well as the type of load expected – should be known when selecting the coupling system. The cost-effectiveness of the coupling should also be considered as an additional selection criterion. Apart from the actual purchase price, acquisition costs, assembly/installation efforts, leak-tightness sustainability and long-term corrosion protection should be taken into account when estimating the total cost.

Wherever possible, use a soft-seal system throughout

Soft sealing systems prevent the development of minute leakage paths which may occur due to settling of the connection, temperature changes and vibration. The VOSS Fluid product range allows the use of elastomers throughout, both on the tube ends and on the male connection side of the coupling. When selecting these seals, observe the different seal material properties.

Trust on VOSS Fluid products for all applications

Essentially, it is possible to combine connecting elements made by different manufacturers, but we recommend the exclusive use of components made by one and the same manufacturer. VOSS Fluid products are perfectly matched to each other and thus ensure optimum operation and quality.

Take advantage of our wide application know-how

VOSS Fluid and its authorized trade outlets have widespread know-how on almost every conceivable application. Reap the benefits of our experience and let us advise you individually before you choose a system.

Always follow VOSS assembly and installation instructions

Leaky connections are usually caused by assembly and installation faults. This is why assembly, installation and operating instructions must be strictly observed. VOSS Fluid offers comprehensive training material as well as practical training courses dealing with all tube connection topics. If you wish, we can hold these at your premises and provide valuable tips specially geared to your particular production processes.

Let VOSS Fluid audit your company regularly

You should check at regular intervals whether internal production procedures have changed, e. g. due to the employment of new fitters, or due to worn machinery or other tools. We offer an audit service for inspecting your assemblies and installation on site.

Check your tubing and hose routing

Make sure that your tubing and hoses are routed and installed properly and that supports are evenly spaced. Mechanical arrangements which are too rigid are not able to absorb vibration whereas sloppily supported tubing systems will tend towards vibrating.

Requirements System features	VOSS Ring ^M	ES-4	VOSSForm ^{SOR}	BV-10	VFS 90 (ORFS)	ZAKO
Standard	DIN EN ISO 8434-1	DIN EN ISO 8434-1	DIN EN ISO 8434-1	DIN EN ISO 8434-1	DIN EN ISO 8434-3 and SAE J 1453	
Type of seal	metallic	metallic + soft sealing	metallic + soft sealing	metallic + soft sealing	metallic + soft sealing	metallic + soft sealing
Material	steel	steel/ stainless steel	steel/ stainless steel	steel	steel	steel
Series	L/S	L/S	L/S	L/S	6-38	16-114.3
Tube-OD	6-42	6-42	6-42	6-42	6-38	16-114.3
Pressure load capability - static/dynamic loads - transmission of external forces	●	●	●●	●	●●	●●
Temperature resistance	●	●	●	●	●	●
Corrosion resistance	●●	●●	●●	●●	●●	●●
Media resistance	●	●	●	●	●	●
Ease of assembly - pre-assembly and final assembly - sources of error, testing possibilities	●●	●●	●●	●	●●	●
On-site assembly - without special tools - possible repair solutions	●●	●●	○	●	○	●
Maintenance - settling behaviour under continuous load - permanent fine sealing	●	●●	●●	●●	○	●●
Flow behaviour - cross-section reduction, dead spaces - pressure loss, noise	●	●	●	○	●	○
System reliability - tearing out, tube fracture - reliability of assembly	●	●	●●	●●	●	●●

●● excellent

● very good

● good

○ average

VOSS Ring^M cutting ring couplings

A reliable way to control high pressures

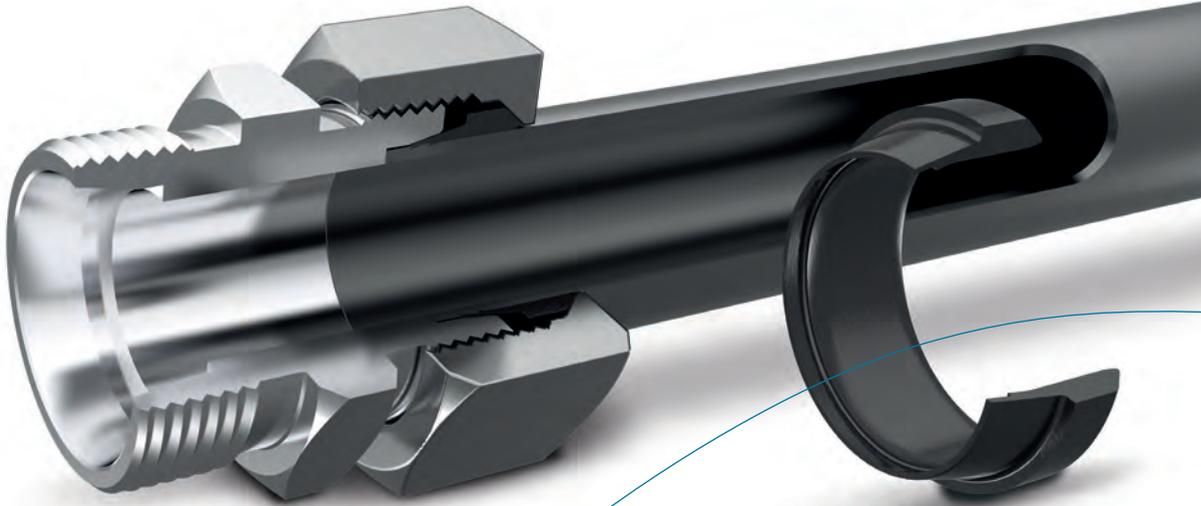

Perfection in every detail

A unique form of superiority

Our development engineers have rethought and optimized every angle and the entire shape of the VOSSRing^M in their pursuit of perfection. The improved cutting geometry ensures maximum leak-tightness. Geometrical reinforcement in all areas exposed to pressure enhance the stability and pressure resistance, while the patented block limit stop makes correct pre-assembly easier.

Improved cutting geometry
for optimal tube indentation

Simple pre-assembly

Feedback through “intelligent” material

Both machine and manual assembly studs are available for pre-assembly of the VOSSRing^M cutting ring system. Both are made from non-wearing high-performance steel and offer a tool service life that is 20 times longer. We prevent the cone contour from widening with a specially developed material. That does away with the need for regular functionality tests. Upon reaching the application limit, the stud breaks, thereby effectively preventing assembly errors due to tool wear.

The advantages:

- Machine and manual assembly studs made from high-performance steel
- Tool service life up to 20 times longer
- Processes free of error without regular functional inspections



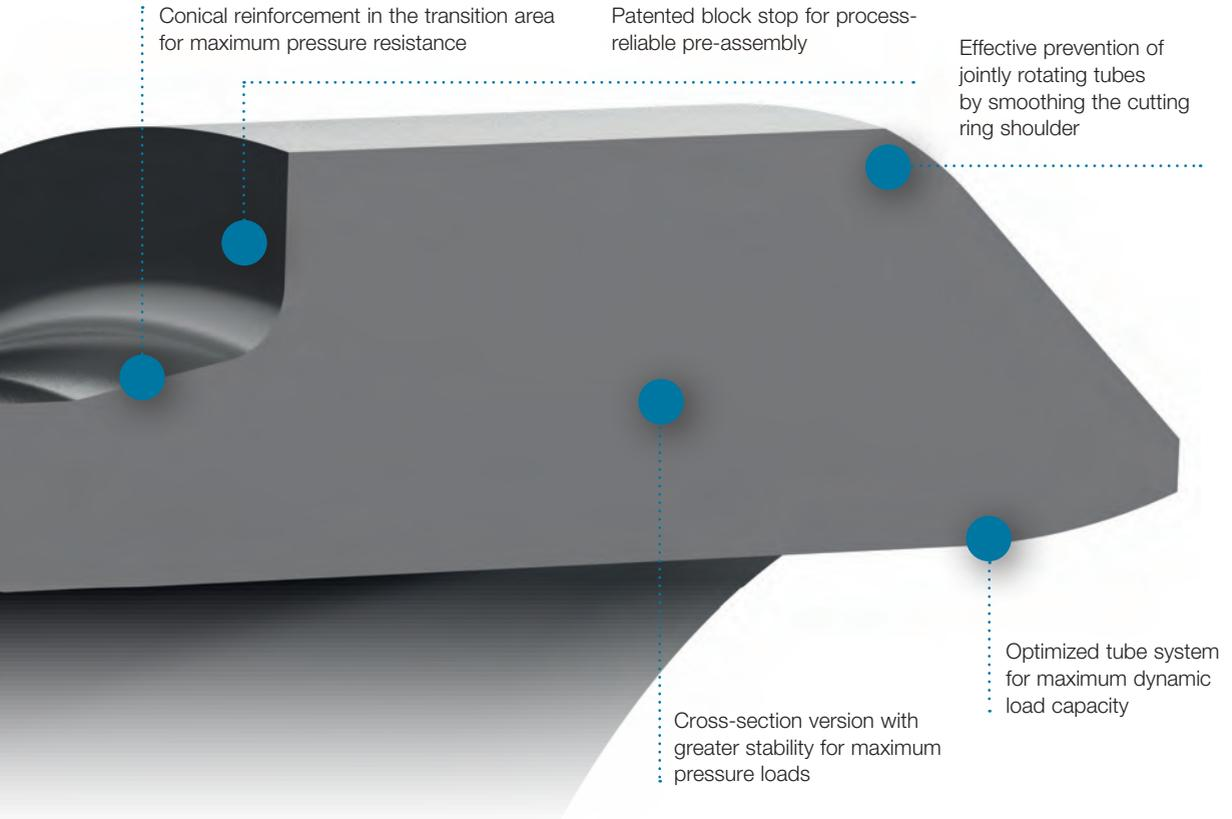

High-tech materials

Special material with unique hardness

VOSS specific special material: We use our specially developed material with very close tolerances in the alloy components for our cutting rings. This ensures a high strength of the extremely homogeneous, fine-grained structure with high toughness and insensitivity to breakage.

Optimized hardening process:

Our refined hardening process creates a very thin and extremely hard edge layer. This ensures a precise and optimum indentation in steel and stainless steel tubes.

The advantages:

- High strength for optimum tube indentation
- High dynamic load-bearing capacity
- Low spring recovery after assembly
- Suitable for use in steel and stainless steel tube

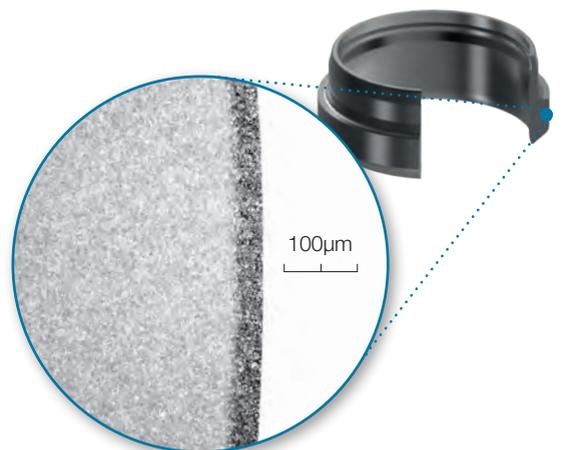

Precise pre-assemblies thanks to patented limit stop concept

As early as the design stage of the pre-assembly stud, we have ensured that errors during assembly are prevented as extensively as possible. This results in a permanently leakproof tube connection at the end. The integral stop function means that the pre-assembly stud comes into contact with the cutting ring with a definite locating surface at the end point of the pre-assembly. The design allows the pre-assembly to be observed precisely and finished at the optimum point – effectively preventing excess assembly.

- Clearly discernible increase in force when using the manual assembly stud
- Pre-assembly devices automatically stop when reaching this block stop

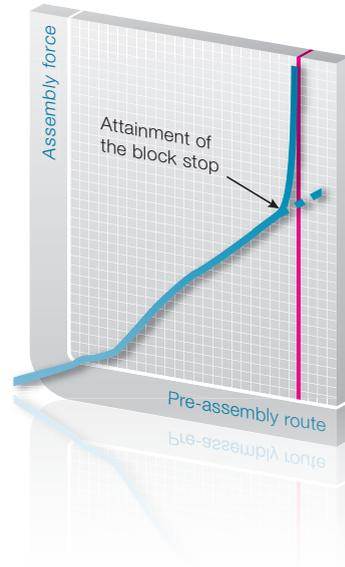
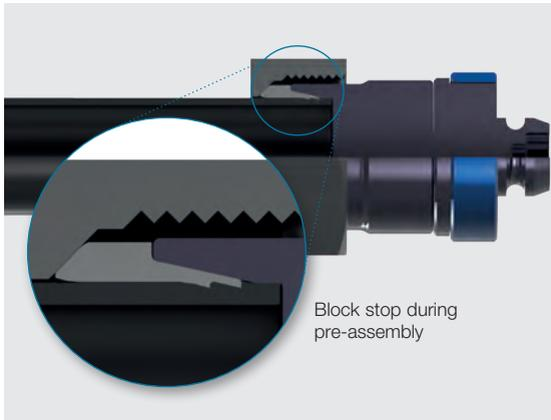

Process-reliable final assembly thanks to extended tools

The extended face of the tool allows an additional clearance to be defined, enabling subsequent cutting of the cutting ring during the later final assembly and providing space for process-reliable repeat assemblies.

- Optimum indentation and fit thanks to additional clearance for subsequent cutting
- Problem-free and standardized repeat assembly capability
- Protection against over-tightening thanks to patented stop concept

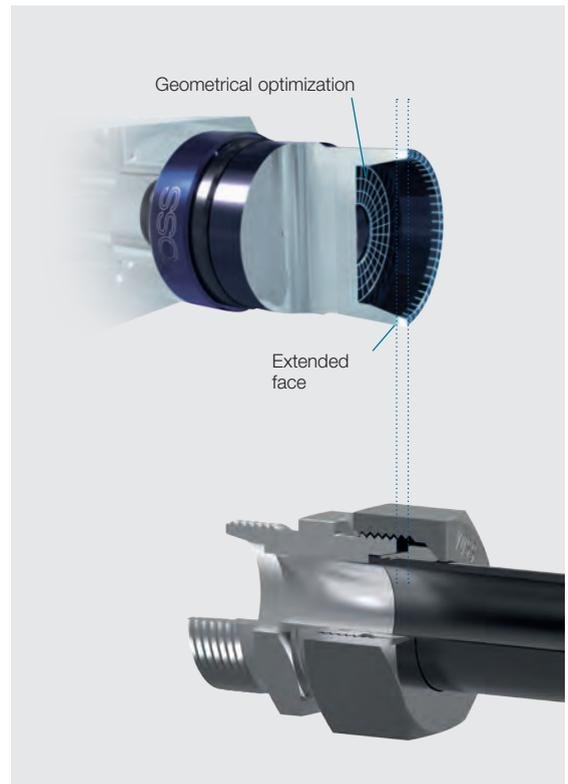

Reduced final assembly route thanks to geometrical optimization

The quality of the VOSS *Ring*^M cutting ring system is also clear in the efficient final assembly. Geometrical optimization in the tube stop area provides a range of benefits for the fitter:

- Reduced final assembly route from 90° to 30°
- Significantly lower workload
- Simplified final assembly in restricted installation situations

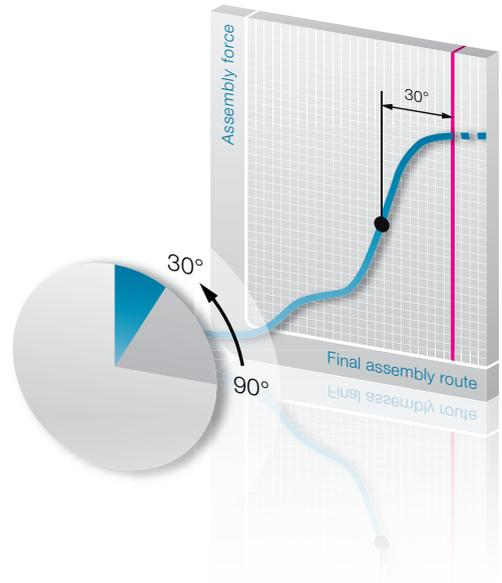

A system for optimum connection

We have perfectly coordinated all components to one another for the full functional scope of the VOSS *Ring*^M cutting ring system. The complete system gives you all the advantages:

- ✓ Limit stop function during pre-assembly
- ✓ Short final assembly route
- ✓ Less effort
- ✓ Protection against over-tightening
- ✓ Reproducible repeat assemblies



The new VOSSRing^M cutting ring system

Our new VOSSRing^M cutting ring system offers you all the advantages familiar from previous 24° cutting ring systems while improving these to a new level of quality and reliability. Special focus was placed during development on an easily and process-reliable assembly, dependable safety against leaks and the use of extremely durable materials. The result is an all-together reliable cutting ring system from VOSS, in both assembly and application.

The most important features at a glance

- Maximum leak-tightness ...
thanks to optimum tube indentation
- HMaximum pressure resistance ...
thanks to geometrical reinforcements
- Very good dynamic loadability ...
thanks to specified cutting ring material by VOSS
- Greater process reliability in assembly ...
thanks to patented stop concept
- Reduced workload ...
thanks to reduced tightening routes
- Reduced effect of incorrect assemblies ...
thanks to non-wearing tools
- Maximum corrosion protection ...
thanks to VOSScoat – BLACK

VOSScoat – now also in “BLACK”

Since as early as 2007, VOSS has been setting standards with VOSScoat, the zinc-nickel based surface, and the same is true for the VOSSRing^M cutting ring system. To prevent mix-ups and make the assembly process more reliable, the new VOSSRing^M is provided with a black coating. Unmistakable design – same quality – equal advantages – easy handling.

VOSScoat guarantees a very long service life

- 1000 hours corrosion resistance in salt spray tests under practical conditions
- More than 2000 hours corrosion resistance in salt spray tests under laboratory conditions when not installed
- Much higher resistance to damage affecting the base coat
- Sustainable production in the company’s state-of-the-art electroplating plant



ES-4 cutting ring couplings

The soft-seal connection with 4-fold benefits

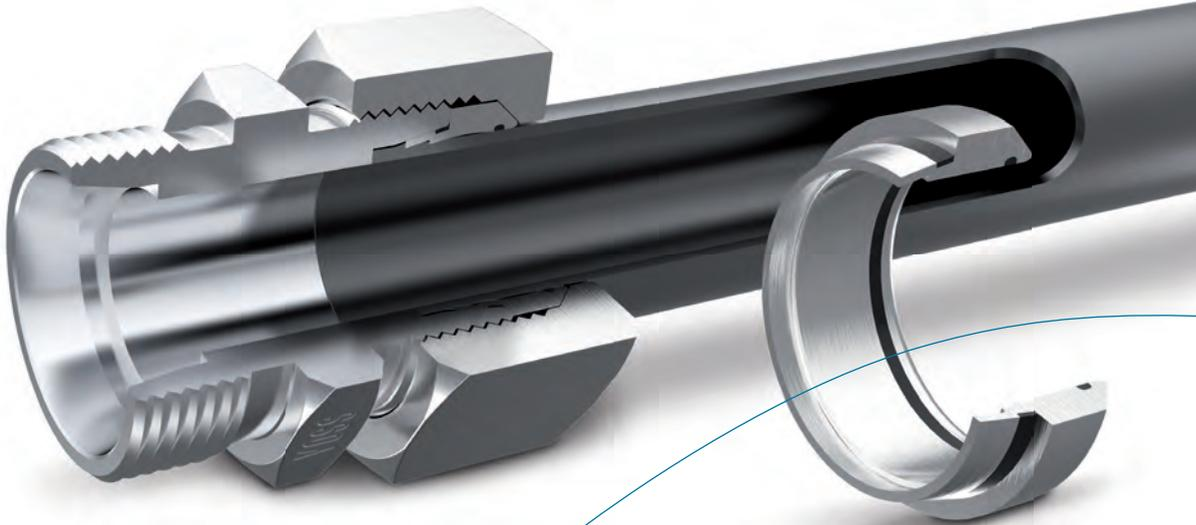

Product information, ES-4 tube couplings

VOSS ES-4: soft seal couplings in accordance with DIN / ISO and with 4-fold benefits:

1. Design based on the tried and tested VOSS cutting ring.
2. Additional precision sealing using soft sealing elements made of FPM/FKM.
3. Reliable leak-tightness thanks to gap-free chambering of the soft seals.
4. Guided assembly up to the tightening torque limit.

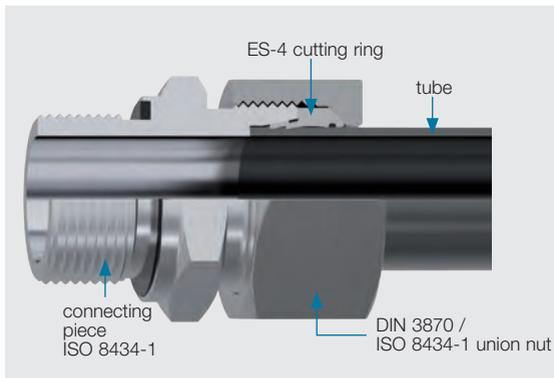

With “ES-4”, VOSS engineers have developed a soft-seal coupling that not only offers additional reliability, but is also much more economical.

As regards the tube connection side, ES-4 couplings cover the application range between the proven cutting ring coupling for standard applications and 10° flared couplings for heavy loads and high stresses.

Leak prevention

The special moulded seal in the groove on the cutting ring taper and the additional O-ring between the cutting ring and the tube eliminate leaks which might otherwise occur due to slackening of the metallic seal, e. g. due to creep characteristics.

Dynamic loads

If the medium succeeds in passing the metallic sealing zone when there is an alternating pressure load, it is stopped by the soft seals located behind the metal seal. The arrangement of the elastomer seals behind the metallic sealing zone means that the alternating pressures can only act on the soft seal after being considerably damped. This quasi-static load, which is lower than the operating pressure, ensures excellent long-term stability of the elastomers.

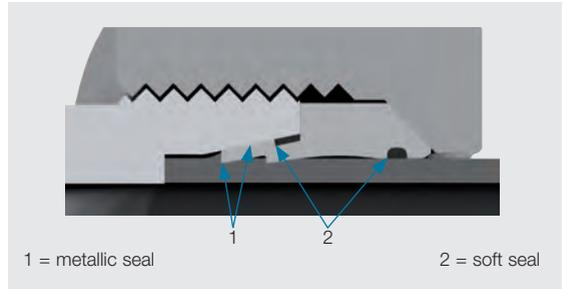

Static loads

Assuming that a leak develops in the metallic sealing zone while the assembly is exposed to static pressure loads, the full operating pressure would build up and act on the front of the soft seal – however with a considerable time delay. In such cases, complete enclosure of the soft-seal elements without any gaps ensures reliable sealing.

VOSS ring as the basis

The basis for the soft seal coupling is the proven VOSS tube couplings conforming to DIN 2353 / ISO 8434-1. In this design, the cutting ring is supplemented by soft seals fitted on the secondary side.

The reliable functional properties of cutting rings remain totally unaffected:

- In the final assembled state, loading by bending moments is counteracted adequately by support from the broad contact area and by the uninterrupted force transfer.
- In addition, the first, strong cutting edge and the additional second cutting edge ensure a secure hold i. e. for tear-out protection in the case of sudden pressure increases.

Additional precision seal with defined seal chambers.

The precision seals prevent the familiar sweating effects of purely metallic seals:

- The special moulded seal of the ES-4 cutting ring, which is set into a groove in the cutting ring taper, seals off any possible leakage path between the cutting ring and the connecting piece.
- An additional O-ring prevents leakage between the cutting ring and the tube.

As a result, both soft seals are located behind the tried and tested metallic seal. With this arrangement, dynamic and static loads are intercepted in the primary zones, i. e. at the metallic sealing points, and only act on the soft seals in a virtually static manner.

Another advantage is that the soft seals are contained in stable, gap-free retention spaces once the cutting rings have been fitted. This prevents extrusion of the soft seals even when exposed to full system pressure.

Safety through block installation

The strong, gap-free enclosure of the fine seal is obtained by a block installation of the ES-4 cutting ring. This is achieved by pressing the moulded seal more strongly onto the coupling taper and by the gap-free radial contact of the cutting ring to the outside tube surface in the area around the O-ring seal. For this purpose, the cutting ring geometry is designed in such a way that maximum possible elasticity is achieved despite the block effect.

Block installation also ensures that the depth of incision is limited, thus counteracting tube constriction when joining thin-walled tubes

It also makes over-tightening of the connection much more difficult.

The same assembly forces are required for block installation as for cutting rings. Also, the same procedure for checking correct cutting ring incision, as required by the standard, can be applied here, and the fitter can use the same working methods and tools.

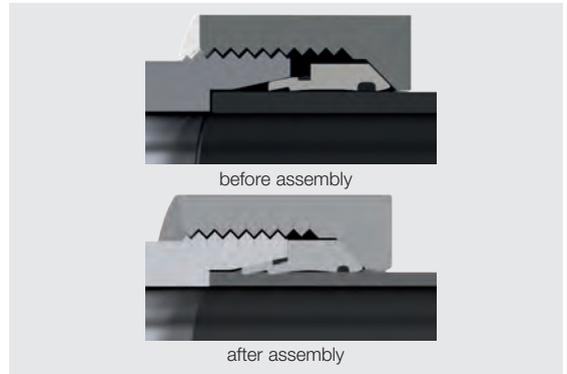

The economic advantages:

ES-4 couplings offer not only a high degree of security against leaks, but additional economic benefits as well:

- Cost and time-intensive corrective measures are no longer required. Production failures are avoided.
- Dry connections help improve the image of the final product, giving final customers advantages over their competitors.
- With the introduction of the ES-4 couplings, VOSS offers a consistent soft seal system. The user can reduce the number of suppliers considerably and thus minimize the number of orders required.
- As ES-4 couplings consist of DIN/ISO connecting pieces and DIN/ISO nuts, the user does not need to establish and maintain a stock of special parts.
- As the user needs to change neither assembly procedures nor tools, additional costs for training and tools are avoided.

Conclusion: In view of the advantages offered by ES-4 couplings regarding greatest possible leak protection, they are an interesting economical alternative from the cost-benefit aspect.

2SVA / ES-4VA cutting ring couplings

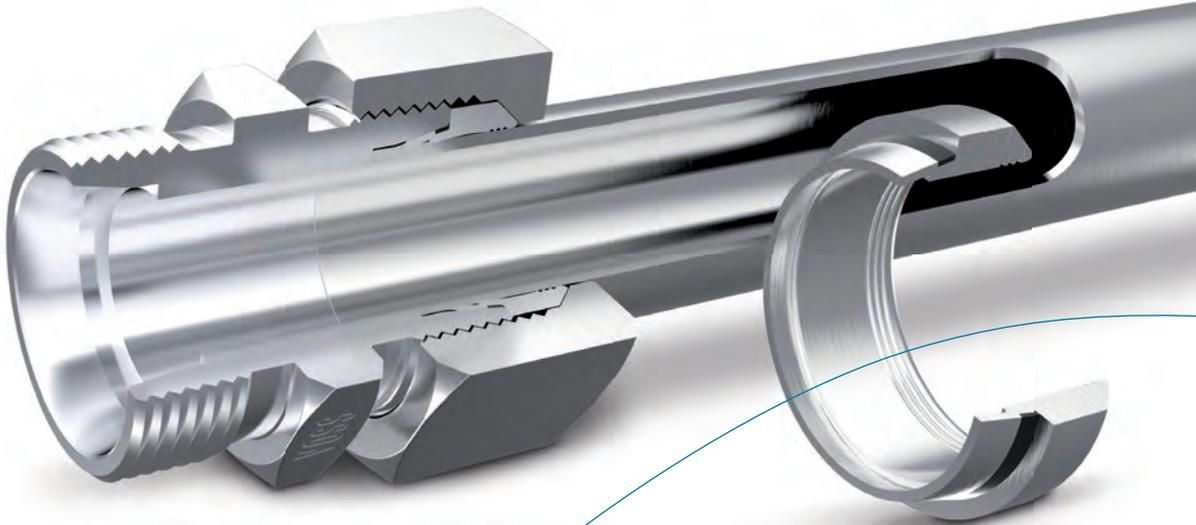

VOSS offers both

2SVA 2-cutting-edge rings and ES-4VA stainless-steel soft-sealing cutting rings.

The standard cutting ring with 2 cutting edges for reliable connection of your piping.

The first cutting edge produces a strong raised material section, ensuring that the tube is held securely.

The following, second cutting edge provides additional safety to deal with higher vibration and alternating bending loads. The fact that this cuts into the tube later balances out the assembly forces.

The elastic behaviour of the ring maintains the pre-tension applied by the assembly forces and prevents leaks which may develop due to settling effects or critical pressure peaks.

ES-4VA soft-sealing cutting rings for maximum safety against leaks in the high-precision sector.

Especially for applications with highly sensitive liquids, 100-percent precision sealing is imperative for protection of the environment and for economical process design.

The four known advantages of the ES-4 cutting rings for steel also apply to ES-4VA cutting rings.

1. Based on tried and tested VOSS cutting rings.
2. Additional precision seal in the secondary area – a soft seal made of FPM / FKM between the cutting ring and the connecting piece creating a labyrinth sealing effect between the cutting ring and the tube.
3. Hermetic encapsulation of the soft seal to prevent it being pressed out when subjected to pressure-change loading, ensuring maximum elastomer service life.
4. Safe assembly thanks to the mechanical stop; over-tightening or under-tightening is practically impossible.

Both cutting rings types can be fitted using standard VOSS pre-assembly devices.

2SVA cutting ring

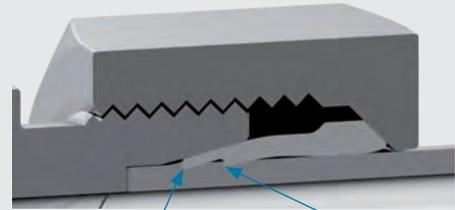

1. cutting edge makes a deep incision
2. trailing cutting edge

ES-4VA cutting ring

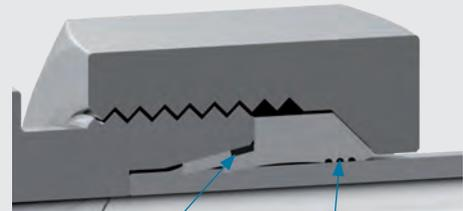

- enclosed soft seal in secondary region
- labyrinth-type seal effect on tube surface

VOSSForm^{SQR} / VOSSForm^{SQR}VA tube couplings

- Safety
- Quality
- Reliability

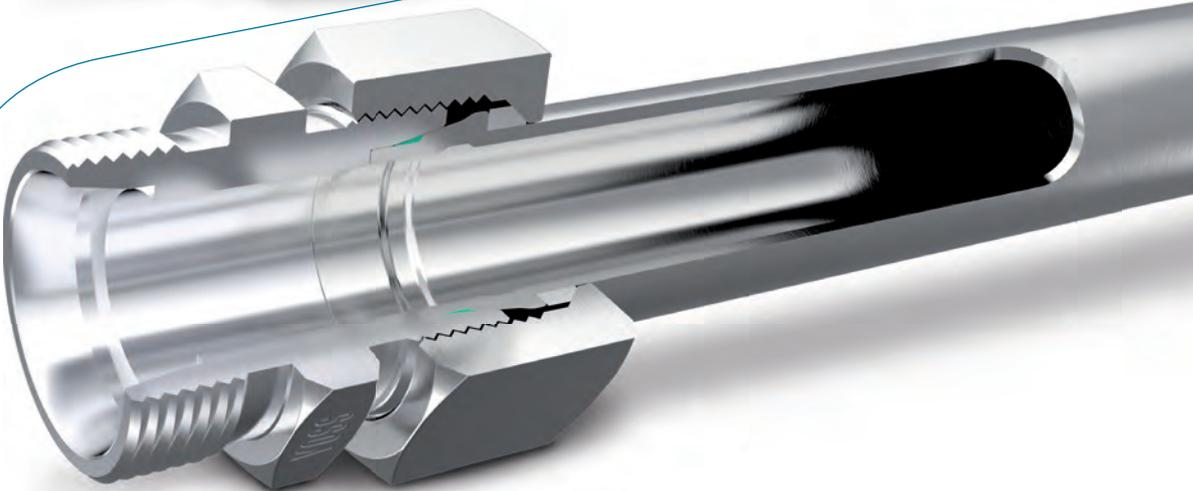
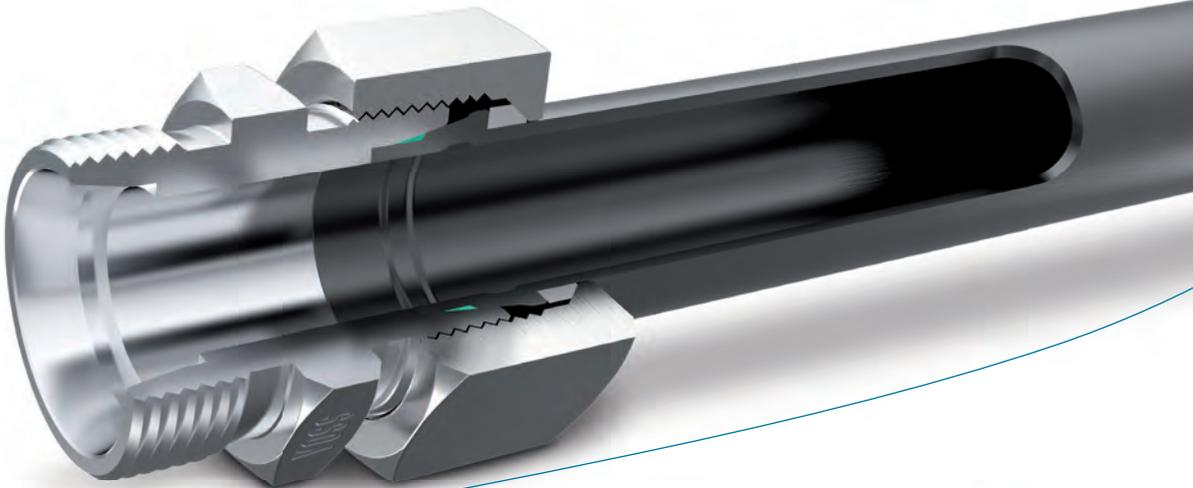

Product information VOSSForm^{SQR} tube couplings

The main requirements placed on hydraulic tube connections can be summed up by three terms:

- Safety, as the most important aspect.
- Quality, without which permanent leak-tightness is not possible.
- Reliability, only an economical coupling achieves market success.

The VOSSForm^{SQR} tube coupling system fulfils these requirements with its innovative design, based on VOSS's proven design principles.

In the VOSSForm100 forming machine a contour is shaped at the end of a commercially obtainable hydraulic tube. When a soft seal and the special SQR function nut are added, the result is a simple, high-quality connection.

Maximum load-bearing capacity and safety

The critical area is the transition from the formed contour to the tube. Here, the forming process can cause the material to become brittle. With the VOSSForm^{SQR} system, this weak point is effectively relieved. Firstly, the radius at the transition minimizes the notch effect, and secondly, the SQR nut with integrated clamping ring clamps the tube radially around the circumference, absorbing the dynamic loads outside of the critical area, thus increasing the pressure load-bearing capacity and breakage resistance.

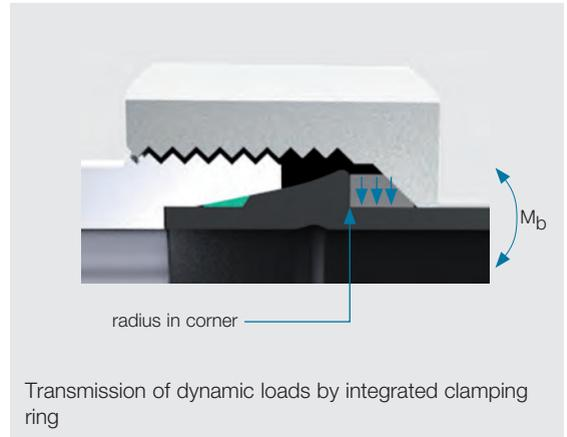

Safe assembly thanks to sure stop

Safe assemblies mean secure connections. With the VOSSForm^{SQR} system, the face of the tube end is pressed against the bottom of a standard DIN/ISO connecting piece during assembly. When the nut is tightened, a noticeable increase in the required torque indicates that assembly is concluded. Slack connections and over-tightening can be virtually eliminated. In addition, the assembly length is reduced and with this, the assembly time. The contour formed on the end of the tube is inserted deeply into the 24° taper to ensure secure seating.

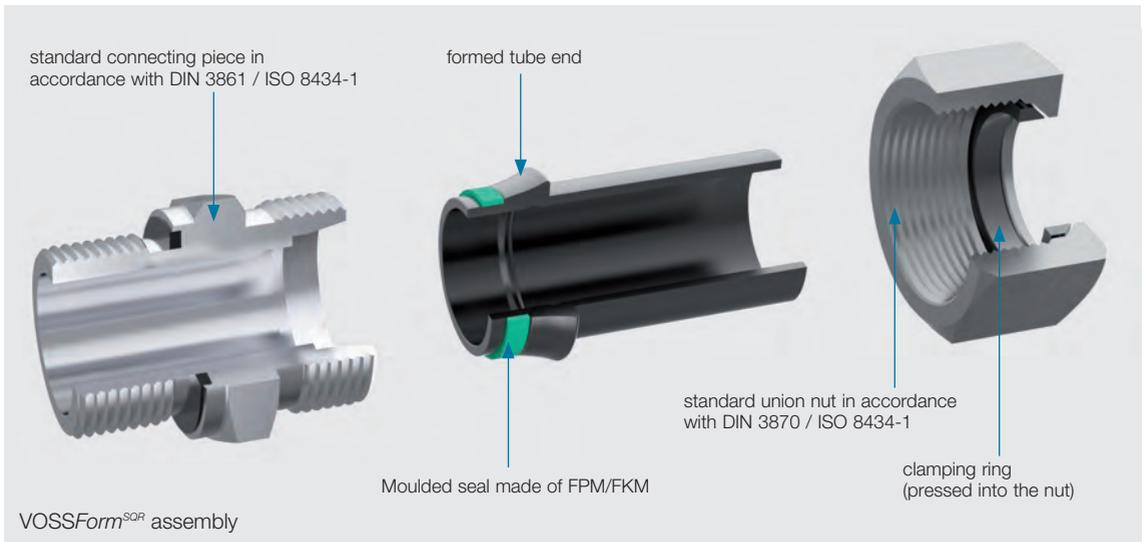

Tube forming with process safety

Forming tubes with the VOSSForm 100 forming machine is as simple as can be. The tube end is simply pushed in as far as the stop plate and the forming process is monitored, allowing for no mistakes. The inner mandrel on the forming head prevents constriction of the tube in the formed area. The inner tube diameter remains completely unchanged, preventing pressure losses due to inward protrusions.

Cycle times between 7 and 15 seconds decrease assembly times, especially in series production.

Soft seals ensure leak-tightness

Soft seals offer considerable advantages over purely metallic seals. Any settling that occurs due to mechanical loads is compensated, effectively preventing connection sweating. A connection that remains completely leak-tight even under the most stringent inspection is more economical, protects the environment and demonstrates the quality of the connection, and thus of the entire product.

The concept of locating the soft seal in the secondary section – as with the ES-4 cutting ring – minimizes both static and dynamic loads on the seal. The metallic primary choking of fluid flow by the face of the tube dampens alternating pressure loading effects. When static pressure loads are applied, there is a long time delay before the pressure acts on the seal. This arrangement ensures long-term stability of the elastomer.

VOSS soft seal located in the secondary section of the connection

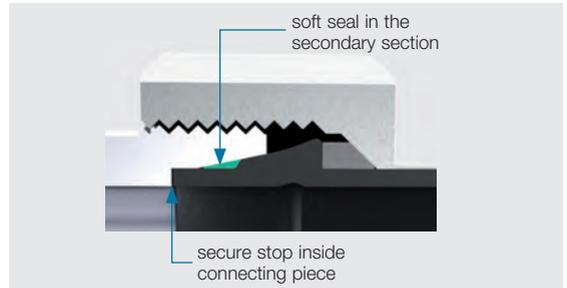
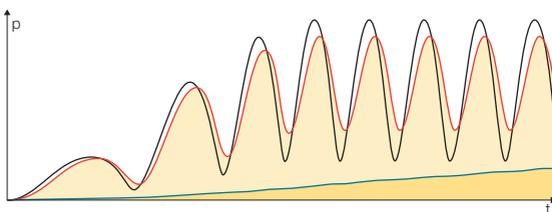

Economical benefits

Avoidance of leaks, minimized assembly time and elimination of maintenance effort and expense make this a sound economical solution. Low material costs and simple parts handling, too, make VOSSForm^{SQR} tube couplings ideal for series production.

Complete product range

Successful use of connection systems requires a wide range of products. The VOSSForm^{SQR} system is based on standardized components, meaning that the entire range of VOSS DIN/ISO products can be used with the VOSSForm^{SQR} system.

VOSSForm^{SQRVA}

The VOSSForm^{SQRVA} forming system is provided for stainless steel applications. All components in this system are made of stainless steel.

The same product characteristics and advantages found in VOSSForm^{SQR} for normal steel applications also apply here.

- Graph of dynamic pressure in the tube
- Conventional connection system with soft seal in primary section
- VOSS system with soft seal in secondary section

High performance paired with simple connection assembly and installation makes VOSSForm^{SQR} a universal connection for series production.

VOSSForm 100 tube forming machine

The VOSSForm 100 forming machine guarantees time-saving, reliable production of the VOSSForm^{SQR} contours. The monitored process, in conjunction with optimum tube guidance, makes it virtually impossible to produce defective forms due to incorrect operation.

Simple tool changes contribute considerably to reducing processing times. The clamping jaws and forming head can be replaced without tools. The distinctive marking of both tools prevents assembly faults due to incorrect combinations of tools and tube dimensions.

The forming process

Forming is started by pushing the tube against the stop plate in the forming machine. The process is triggered by pressing the Start button (1.).

The clamping jaws close and clamp the tube in place. The stop plate is swung out of the forming area (2.).

The forming head moves forward and shapes the tube by plastic deformation to produce the VOSSForm^{SQR} contour (3.).

The forming head is retracted and the clamping jaws open again (4.).

Removal of the tube is monitored. This allows the machine to automatically return to the idle position, and the next tube forming sequence can be started without manual reset (5.).

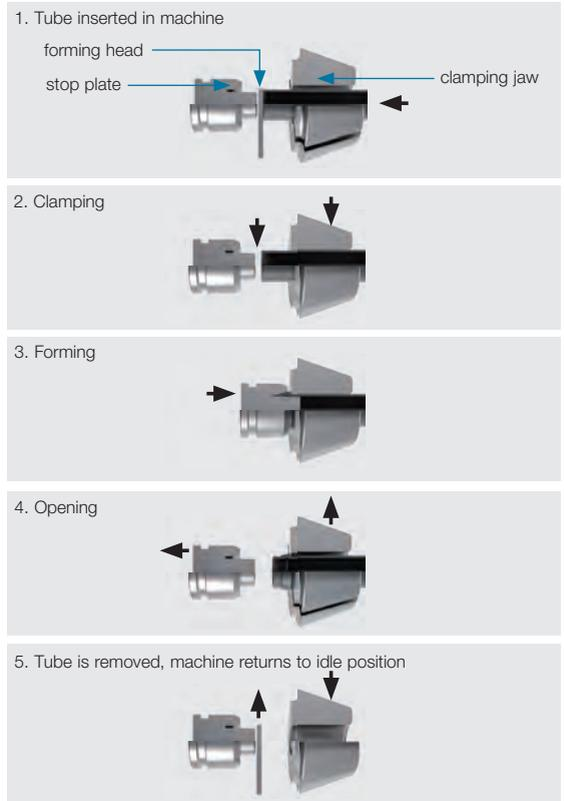

Forming machine details



BV-10 flared couplings

For extreme load conditions

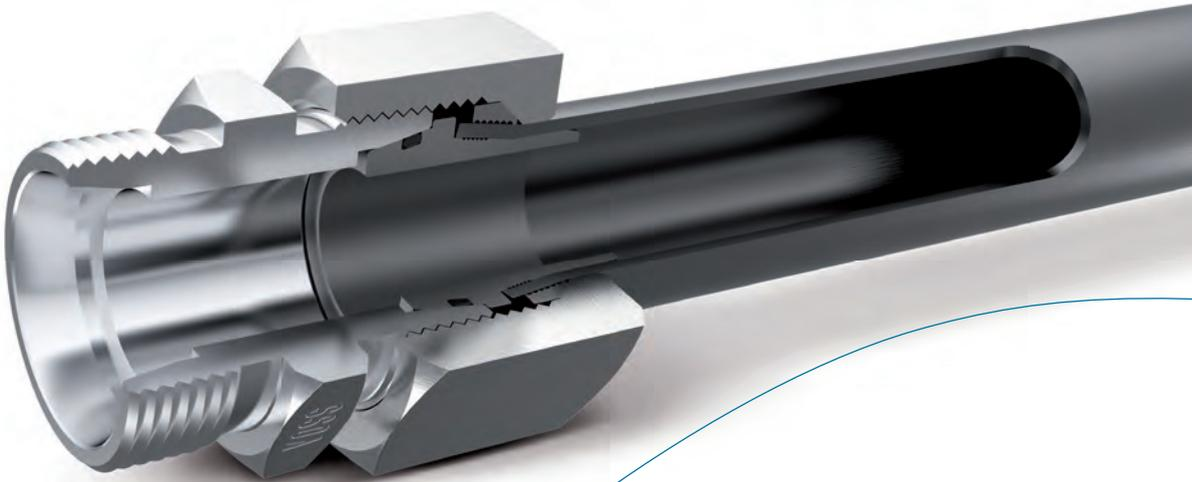

Product information, 10° flared coupling system

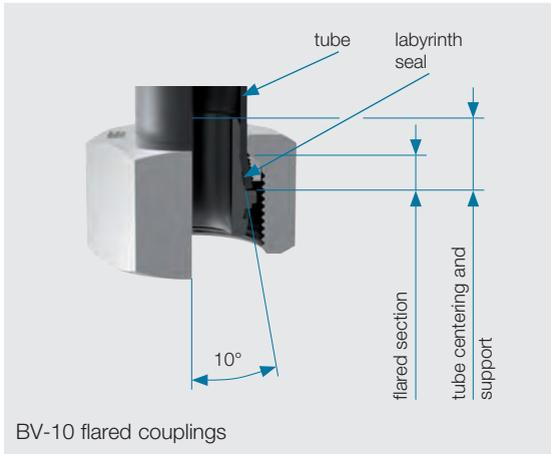

The VOSS 10° flared coupling system complements the tried and tested VOSS cutting ring programme for heavy-duty and extreme load applications (see application diagram). BV-10 flared couplings are the ideal solution for applications exceeding the capacity of cutting ring couplings, since the 10° flared coupling systems have sustained ability to cope with alternating bending stresses, sudden pressure increases, pressure peaks, vibrations and temperature fluctuation.

At the tube end, this system – as opposed to standard systems – applies a flare angle of 10°.

The connection end toward the device – either directly or via a connecting piece – is designed to fit off-the-shelf or standardized connections. The combination of a flared cone and clamping ring or a ZAKO ring and flange provides excellent hold, ensuring maximum operational safety even under extreme loads.

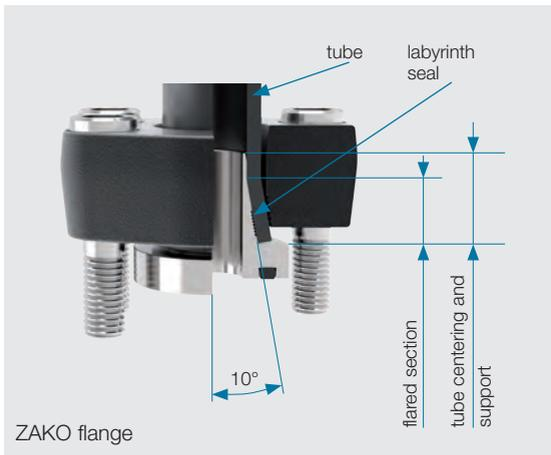

Both the BV-10 coupling and the ZAKO flange system are based on the 10° flared coupling principle.

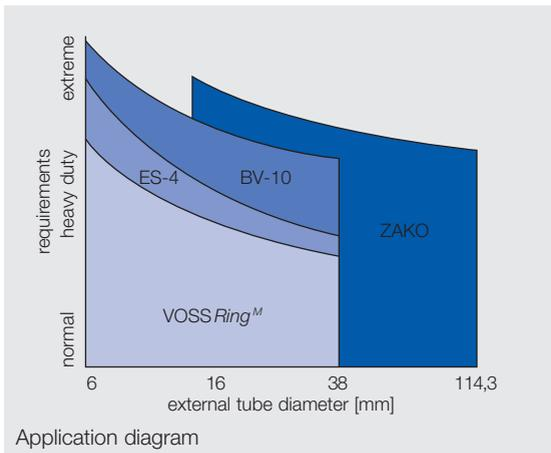

BV-10 flared couplings

Users are offered a complete range of couplings comprising both a light-weight and a heavy-duty series. The BV-10 flared coupling is based on the use of DIN/ISO coupling pieces with 24° cones, making it easily interchangeable with cutting ring and weld nipple systems.

As shown in the diagrams below, the tube clamp – in conjunction with the 10° flared cone of BV-10 flared couplings – provides the pre-loading required for a secure connection to the tube. The sealing effect on the connecting piece is ensured by the time-proven DKO head of the flared cone with a metal sealing effect and by a completely enclosed soft-seal packing.

On the tube connection side, the sealing effect is achieved by surface pressure on the flared section and by the labyrinth seal effect of the small “teeth” on the cone surface. The clamping ring presses on a large area of the tube end and the flared cone, ensuring extremely high holding forces. As a result, the system remains leak-tight even when exposed to vibrations or alternating bending moments.

The pressure ratings of VOSS BV-10 flared couplings correspond to those of 24° taper couplings or 24° cutting-ring couplings.

Advantages of the 10° flared coupling system

Hydraulic engineers will appreciate the following characteristics of BV-10 tube couplings:

- Particularly suitable for extreme loads and stresses.
- The 10° flared cone principle ensures that tubing is held without notching and incision effects.
- Suitable for use with standard coupling hole diameters and connecting pieces.
- Easy assembly, even with thick-walled tubes.
- Elimination of assembly errors, as the flared cone ring has to be pre-assembled in a special assembly tool.
- Suitable for stainless-steel tubes with tolerances as specified in DIN 10305-1.
- Complete range of couplings in the L and S series.

Note on safety:

Widely differing operating conditions often subject tube connections to loads with unforeseeable parameters. To ensure safe operation, please observe the following:

- Always take the tube wall thickness into consideration as well as the external diameter of the tube.
- VOSS 10° flared couplings may only be pre-assembled with VOSS pre-assembly machines especially designed for this purpose.
- Always observe the assembly instructions of the device being used!

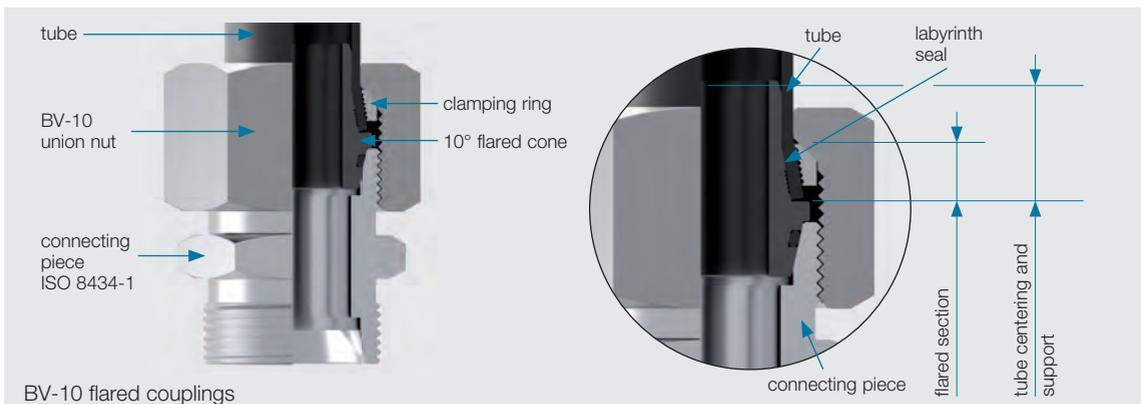

24° taper couplings / welding couplings

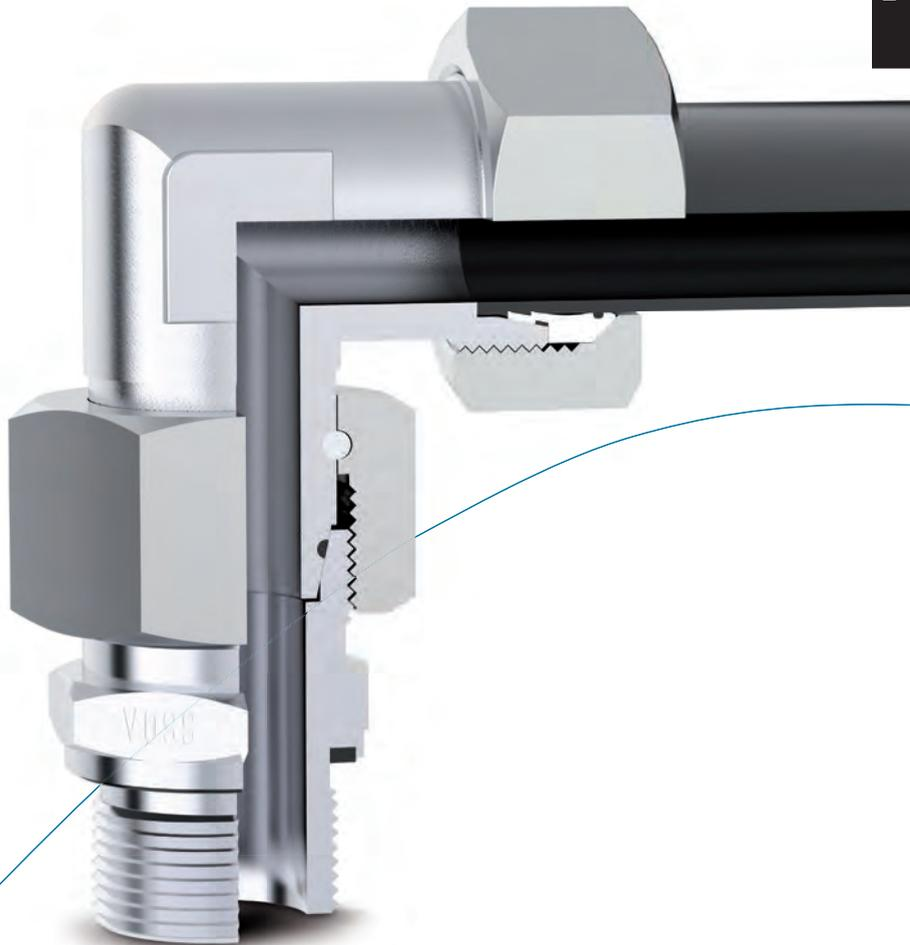

Product information 24° taper couplings

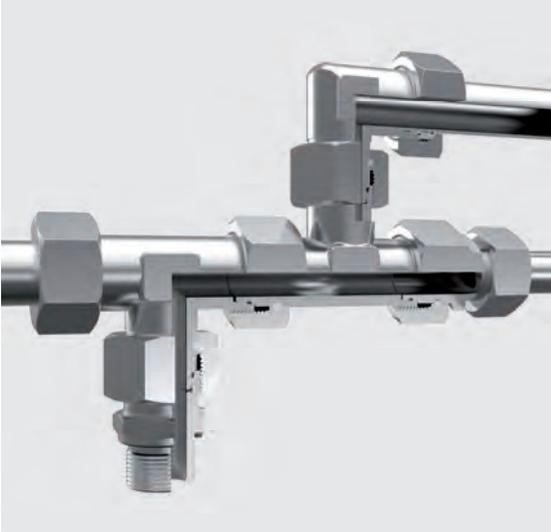

The 24° taper coupling is a logical further development to provide an adjustable coupling with a tube socket and pre-assembled cutting ring. The taper on the coupling body achieves a particularly reliable and permanently stable coupling connection.

The gripping function is achieved by a special union nut with a wire pin located in a groove. In the assembled state, the interlocked union nut ensures a coupling that reliably stops the tube from being torn out.

Sealing is provided by an embedded O-ring. The result is a perfect precision seal.

The broad range of different designs allows the production of all common combinations of couplings with adjustable directions. The connection dimensions conform exactly to the DIN 2353 / ISO 8434-1 standards. This allows interchangeability with conventional adjustable spigot versions.

Special features:

- VOSS taper couplings provide improved leak-tightness and precision sealing by means of the precisely enclosed O-ring seal.
- They achieve long-term leak-tightness even under extreme operating conditions, such as sudden pressure increases, alternating bending loads and vibrations.
- VOSS taper couplings can be assembled easily and reliably. The optimum final function is achieved with a short tightening travel and a practical final tightening torque.
- Repeated separation and re-assembly can be carried out frequently and without any difficulty.

General Note

In order for the taper couplings to fulfil their function, it is of utmost importance to follow the installation instructions and the notes in the technical remarks exactly.

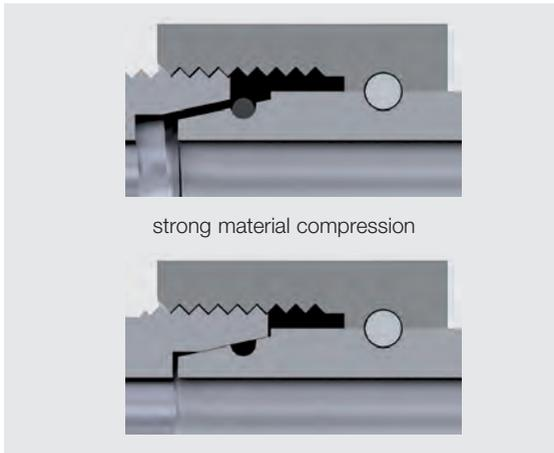

strong material compression

Distance adapters with sealing cone and O-rings

Distance adapters (spacers) for bore shapes W DIN 3861 / ISO 8434-1 are mainly used for extending couplings that have been altered.

Furthermore, they can be used to replace existing cutting-ring couplings without any great effort, e. g. due to maintenance work. This means that existing tubing can remain in place.

Special features:

- The VOSS taper coupling provides improved leak-tightness and precision sealing by means of the precisely enclosed O-ring seal.
- It achieves long-term leak-tightness even under extreme operating conditions, such as sudden pressure increases, alternating bending loads and vibrations.
- VOSS taper couplings can be assembled easily and reliably. The optimum final function is achieved with a short tightening travel and a practical final tightening torque.
- Repeated disassembly and reassembly poses no problem.



Distance adapter with sealing cone and O-rings



Distance adapter

Product information, welding couplings



VOSS welding couplings and weld nipples supplement the product range of conventional cutting ring, tube forming and flared coupling systems.

Welding couplings are increasingly becoming a special niche solution owing to their limited usability and high costs, and the pre-treatment of the tube, welding processes, specialized qualifications, post-treatment and inspection involved.

VOSS weld nipples with a 24° taper and O-ring can be combined with all tube couplings conforming to DIN 2353 / ISO 8434-1 and the corresponding coupling pieces.



Customer designed products – individualized customer solutions

As a competent system partner offering a wide range of standardized and off-the-shelf components, VOSS Fluid can offer individual special solutions and supply parts produced to drawings according to the customer's specifications.

Our special products range from couplings for use as length adapters, chokes, diameter adapters or special designs, right up to and including non-return valves with specific opening pressures.

Our experience, creativity and cutting-edge production technology can be used to develop individual solutions which will win your approval and guarantee your success.



Tube connection parts, 24° connecting piece range
and individual parts / accessories



Content

Type/Page

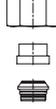
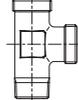
The new product designations of VOSS products	P.50				
Cutting rings	VRM	2SVA	ES4		
					
	P.58	P.59	P.60		
DIN union nuts	N				
					
	P.62				
SQR-function nuts	SQRNMS				
					
	P.64				
BV-10 tube connecting parts	BV10CO	BV10R	BV10N	BV10SO	
					
	P.66	P.68	P.69	P.70	
24/37° tube connecting parts	24/37AO	24/37R	24/37N	24/37SO	
					
	P.74	P.75	P.76	P.77	
Male stud couplings	SDS	SD2S	SDE	SDL	SDT
					
	P.80	P.102	P.104	P.108	P.110

Content

Type/Page

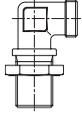
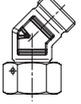
Content	S	S	E	T	T
Connecting adapters	 P.114	 P.115	 P.117	 P.118	 P.119
	K				
	 P.122				
Bulkhead couplings	BHSLN  P.124	BHELN  P.125			
Banjo and rotary couplings	BSE  P.128	BEE  P.132	BCE  P.136	BCT  P.140	RCE  P.142
Adjustable couplings with tube socket, plug-in version	SWE  P.146	SWT  P.147	SWL  P.148	SWSDS  P.149	SWS  P.154
24° taper couplings	SW2OS  P.160	SW2OS  P.162	SWOK  P.165	SWOE  P.166	SWOE45  P.167
	SWOT  P.168	SWOL  P.169	SWOSDS  P.170	SWOS  P.173	SWOS  P.177

Content

Type/Page

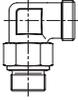
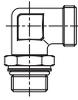
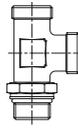
Adjustable couplings with lock nut	SDAE	SDAE	SDAE45	SDAL	SDAT
					
	P.180	P.182	P.183	P.184	P.185
Welding couplings	WDS	WDBHS	WDNPSO		
					
	P.188	P.189	P.190		
Female stud and gauge couplings	S	PGS	SWPGS	SWOPGS	
					
	P.194	P.197	P.198	P.199	
Thread reducing couplings	SDS				
					
	P.200				
Straight adapters ISO 6149 / DIN 3852	SDS				
					
	P.204				
Blanking screws	PLIH / PLEH				
					
	P.205				
Blanking plugs / tube blanking screws	PLB	PLO / PLOC	TBS		
					
	P.208	P.209	P.211		

Content	Type/Page				
Hexagonal nuts	LN				
	 P.212				
Reinforcing sleeves	RS				
	 P.213				
Sealing rings	ES4MS	SR	OR (banjo c.)	PEFLEX	OR (DKO/BV-10)
	 P.218	 P.219	 P.220	 P.222	 P.227
	OR (flange c.)	SQRMS	OR (24/37°)		
	 P.230	 P.231	 P.233		

The new designations of VOSS products



This catalog contains a new, alphanumerical product designation system based to a large extent on ISO 8434-1. This makes the designation self-explanatory and facilitates identification of the products. Since the structure is based on English, the designation is understood internationally.

Furthermore, the new product designations make it possible to generate customized special solutions by combining variations of the existing VOSS product program.

Example: 24-SDSC-L18-M22E-ES4

	24	-	SD	S	C	-	L
System							
24° DIN program							
The "system" characteristic describes the product line.							
Function/Component							
Stud coupling							
The "function/component" characteristic describes the product type.							
Form							
Straight							
Details on component shape.							
Completion							
Complete connection (with tube connecting system)							
This characteristic identifies the components (e. g. hexagonal nut, union nut and cutting ring, O-ring ...) that can be used to complete the product type. Complete couplings are supplied with VOSS <i>Ring^M</i> cutting rings by default, other connection systems are listed in the "Suffix" characteristics.							
Series/Thread							
Light series							
Determines the series.							

Straight male stud coupling; size L18 with metric fine thread M22x1.5, cylindrical; completed with "PEFLEX" profile ring seal and ES-4 cutting ring and union nut.



Examples of how to order items, as well as additional explanations and variation options are given in the respective chapters and in the following pages for the individual product groups.

18	M	22	E	ES4	
					Suffix 5
					ES-4 cutting ring
					Deviations from the default characteristics (e. g. seal materials, completion using different cutting-ring systems, flared coupling parts, special dimensions ...)
					Sealing type/Threaded bore
					Elastomeric sealing
					Type of seal for the connecting thread.
					Diameter
					22 mm
					States the nominal thread size (pitch is not stated for metric and imperial thread sizes).
					Thread
					Metric
					Identifies the type of thread.
					Tube OD/Diameter
					OD in L series
					States the outer diameter of the tube.



System	
24	24° DIN program
GP	General program (components and accessories, applicable in different connecting systems)

Function	
Component 37°	
24/37A	24/37° adapter
24/37N	24/37° nuts
24/37R	24/37° rings
24/37S	24/37° sets

Cutting rings	
1S	1S Cutting rings
VRM	VOSSRing ^M Cutting rings
ES4	ES-4 Cutting rings
ES4MS	ES-4 Moulded seals
ES4OR	ES-4 O-rings

BV-10	
BV10C	BV-10 Cones
BV10N	BV-10 Union nuts
BV10R	BV-10 Clamping rings
BV10S	BV-10 Sets

Plugs	
PLB	Plugs, metal-to-metal sealing
PLO	Plugs with O-rings

Sealings	
OR	O-rings
PEFLEX	PEFLEX sealing rings
SR	Sealing rings

Sleeves	
RS	Reinforcing sleeves

Screws	
PLEH	Plug screws with external hex
PLIH	Plug screws with internal hex
TBS	Tube blanking screws

VOSSForm^{SQR}	
SQRMS	SQR Moulded seals
SQRN	SQR-function nut without moulded seal

Banjo couplings	
BE	Banjo couplings, eccentric design
BC	Banjo couplings, compact design
BS	Banjo couplings, standard design



System	Function/ Component	Form	Completion	Series/ Thread	Tube OD/ Diameter	Thread	Diameter	Sealing type/ Threaded bore	Suffix
--------	------------------------	------	------------	-------------------	----------------------	--------	----------	--------------------------------	--------

Diagnostic couplings	
PG	Pressure gauges
Swivel couplings	
SW	Swivel couplings with cutting ring and nut
SWO	Swivel with O-ring
SWOPG	Swivel with O-ring with pressure gauges
SWOSD	Swivel studs with O-ring
SWPG	Swivel pressure gauges
SWSD	Swivel stud with cutting ring and nut
SW2O	2-sided swivels with O-ring
Weld-on/Weld-in couplings	
WDBH	Weld-in bulkhead couplings
WDNP	Welded nipples
WD	Weld-on couplings
Others	
BH	Bulkhead couplings
LN	Locknuts
N	Union nuts
RC	Rotary couplings
SD	Stud couplings
SDA	Stud couplings adjustable

Form

E	Elbow
E45	45° elbow
K	Cross
L	L
S	Straight
T	Tee

Completion

C	Complete connection (with tube connecting system)
LN	Locknut
LNC	Complete connection with locknuts
MS	Moulded sealing SQR
O	O-ring enclosed
X	Tube socket not pre-assembled / only body
XC	Complete connection at tube side, tube socket not pre-assembled

Series/Thread

Series

LL	Extra light series
L	Light series
S	Heavy series
L/S	Light and heavy series are identical

Thread

M	Metric
G	Whitworth parallel
R	Whitworth tapered
U	UNF
N	NPT
IM	Internal thread, metric
IG	Internal thread, Whitworth parallel

Tube OD/Diameter

6	6 mm
8	8 mm
10	10 mm
12	12 mm
14	14 mm
15	15 mm
16	16 mm
18	18 mm
20	20 mm
22	22 mm
25	25 mm
28	28 mm
30	30 mm
35	35 mm
38	38 mm
42	42 mm

Sealing type/Threaded bore

A	Metal-to-metal flat face sealing
B	Metal-to-metal sealing shoulder
E	Elastomeric sealing
F	O-ring sealing
T	Tapered



Suffix overview

Suffix 4	Sealing material
Suffix 5	Completion
Suffix 6	Differing dimension
Suffix 7	Material/Strength
Suffix 8	Coating
Suffix 11	Customized product

Suffixes not referred to here are not relevant to this chapter.

Note: For articles having more than one relevant suffix, these are listed in numerical order in the sales designation.

Suffix 4 Sealing material

EPDM80	EPDM 70-80
EPDM85	EPDM 85
FKM70	FKM 70
FKM80	FKM 80
FKM90	FKM 90
NBR80	NBR 70-80
NBR85	NBR 85
NBR90	NBR 90

Suffix 5 Completion

1S	1S Cutting ring
ES4	ES-4 Cutting ring
BV10	BV-10 Set
24/37	24/37° Set

Suffix 6 Differing dimension

	Height
H2,5	Height 2.5 mm
...	...
	Length
LG17	Length 17 mm
...	...
	Wrench size
WS19	Wrench size 19 mm
...	...
	Others
P	Profile material
HB	Hexagon body

Suffix 7 Material/Strength

ST	Steel
SST	Stainless Steel
BS	Brass



Suffix 8	Coating
C00	Steel, blank, washed and oiled, production stage
C10	Steel, phosphated and oiled
C21	Zinc-nickel transparent passivated, sealed and lubricated
C62	Stainless steel, hardened

Suffix 11	Customized product
CP1	Differing to VOSS standard
CP2	Differing to VOSS standard
CP12	Differing to VOSS standard

Cutting rings

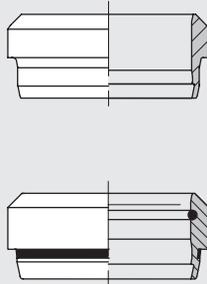

1S and VOSSRing^M cutting rings

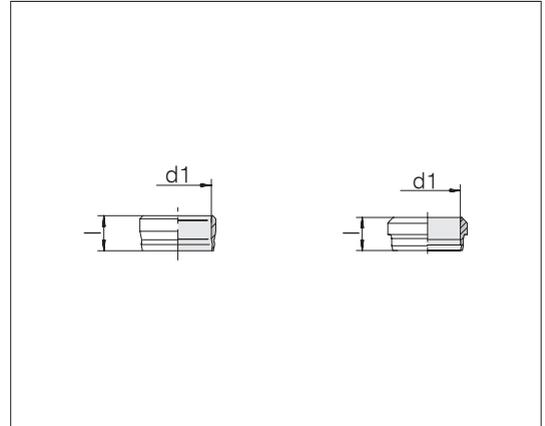

Series	Pressure	l	Order-No.	Designation
Tube OD d1				
LL 4	PN 100	6.8	0006002000	24-1S-LL4
LL 5	PN 100	7.8	0006052000	24-1S-LL5
LL 6	PN 100	7.8	0006102000	24-1S-LL6
LL 8	PN 100	7.8	0006152000	24-1S-LL8
L/S 6	PN 500/800	9.2	0019002100	24-VRM-L/S6
L/S 8	PN 500/800	9.2	0019052100	24-VRM-L/S8
L/S 10	PN 500/800	10	0019102100	24-VRM-L/S10
L/S 12	PN 400/630	10	0019152100	24-VRM-L/S12
L 15	PN 400	10.2	0019202100	24-VRM-L15
L 18	PN 400	10.5	0019252100	24-VRM-L18
L 22	PN 250	11.2	0019302100	24-VRM-L22
L 28	PN 250	11.2	0019352100	24-VRM-L28
L 35	PN 250	13.4	0019402100	24-VRM-L35
L 42	PN 250	13.4	0019452100	24-VRM-L42
S 14	PN 630	10.2	0019702100	24-VRM-S14
S 16	PN 630	10.2	0019752100	24-VRM-S16
S 20	PN 420	13	0019802100	24-VRM-S20
S 25	PN 420	13	0019852100	24-VRM-S25
S 30	PN 420	13.6	0019902100	24-VRM-S30
S 38	PN 420	13.5	0019952100	24-VRM-S38

Cutting-rings for tube OD
6 - 12 mm are identical for
series L + S .

Series LL = 1S
Series L + S = VOSSRing^M

Example for comp. :
D04LLX
DIN 3861-ALL4-St

PSR06LX
ISO 8434-1-CR-L6-St



2SVA cutting rings

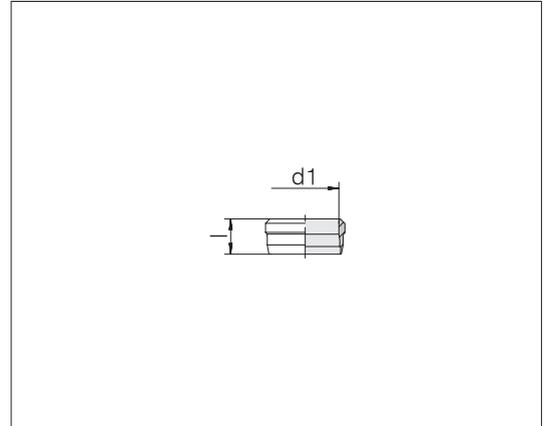

3

Series	Tube OD	Pressure	l	Order-No.	Designation
L/S	6	PN 315/630	8.8	0010006200	24-2S-L/S6-SST-C62
L/S	8	PN 315/630	8.8	0010056200	24-2S-L/S8-SST-C62
L/S	10	PN 315/630	9.8	0010106200	24-2S-L/S10-SST-C62
L/S	12	PN 315/630	9.8	0010156200	24-2S-L/S12-SST-C62
L	15	PN 315	10.2	0010206200	24-2S-L15-SST-C62
L	18	PN 315	10.2	0010256200	24-2S-L18-SST-C62
L	22	PN 160	11.5	0010306200	24-2S-L22-SST-C62
L	28	PN 160	11.5	0010356200	24-2S-L28-SST-C62
L	35	PN 160	13.5	0010406200	24-2S-L35-SST-C62
L	42	PN 160	13.5	0010456200	24-2S-L42-SST-C62
S	14	PN 630	10.2	0010706200	24-2S-S14-SST-C62
S	16	PN 400	10.2	0010756200	24-2S-S16-SST-C62
S	20	PN 400	12.5	0010806200	24-2S-S20-SST-C62
S	25	PN 400	12.5	0010856200	24-2S-S25-SST-C62
S	30	PN 400	13.5	0010906200	24-2S-S30-SST-C62
S	38	PN 315	13.5	0010956200	24-2S-S38-SST-C62

Cutting-rings for tube OD
6 - 12 mm are identical for
series L + S .

Example for comp. :
DPR06L71X

ES-4 / ES-4VA cutting rings

Standard material of moulded seals and O-rings is FPM/FKM

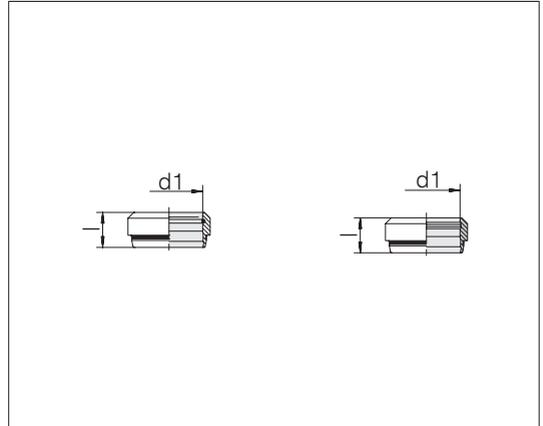

Series	Pressure	l	Order-No.	Designation steel	Order-No.	Designation stainless steel
Tube OD						
d1						
L/S 6	PN 500/800	8.8	0011002039	24-ES4-L/S6	0011006039	24-ES4-L/S6-SST
L/S 8	PN 500/800	8.8	0011052039	24-ES4-L/S8	0011056039	24-ES4-L/S8-SST
L/S 10	PN 500/800	9.8	0011102039	24-ES4-L/S10	0011106039	24-ES4-L/S10-SST
L/S 12	PN 400/630	9.8	0011152039	24-ES4-L/S12	0011156039	24-ES4-L/S12-SST
L 15	PN 400	10.2	0011202039	24-ES4-L15	0011206039	24-ES4-L15-SST
L 18	PN 400	10.2	0011252039	24-ES4-L18	0011256039	24-ES4-L18-SST
L 22	PN 250	11.5	0011302039	24-ES4-L22	0011306039	24-ES4-L22-SST
L 28	PN 250	11.5	0011352039	24-ES4-L28	0011356039	24-ES4-L28-SST
L 35	PN 250	13.5	0011402039	24-ES4-L35	0011406039	24-ES4-L35-SST
L 42	PN 250	13.5	0011452039	24-ES4-L42	0011456039	24-ES4-L42-SST
S 14	PN 630	10.2	0011702039	24-ES4-S14	0011706039	24-ES4-S14-SST
S 16	PN 630	10.2	0011752039	24-ES4-S16	0011756039	24-ES4-S16-SST
S 20	PN 420	12.5	0011802039	24-ES4-S20	0011806039	24-ES4-S20-SST
S 25	PN 420	12.5	0011852039	24-ES4-S25	0011856039	24-ES4-S25-SST
S 30	PN 420	13.5	0011902039	24-ES4-S30	0011906039	24-ES4-S30-SST
S 38	PN 420	13.5	0011952039	24-ES4-S38	0011956039	24-ES4-S38-SST

Cutting-rings for tube OD
6 - 12 mm are identical for
series L + S .

Example for comp. :
ISO 8434-1-CR-L6-St

DIN union nuts

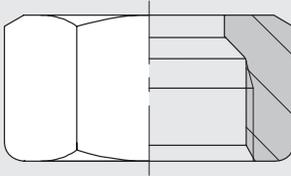

Union nuts

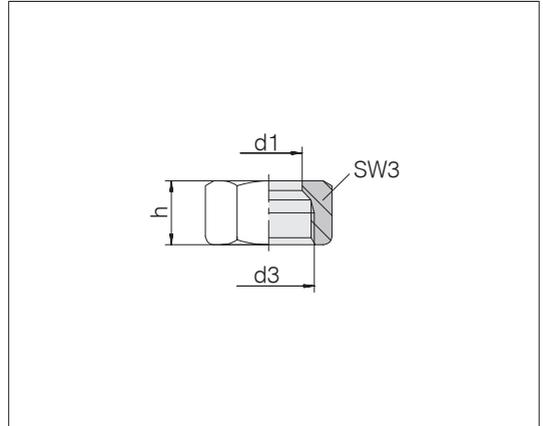

Series	d3	Pressure	SW3	h	Order-No.	Designation steel	Order-No.	Designation stainless steel
Tube OD d1								
LL 4	M 8 x 1	PN 100	10	11	0003002100	24-N-LL4	0003006000	24-N-LL4-SST
LL 5	M 10 x 1	PN 100	12	11.5	0003052100	24-N-LL5	0003056000	24-N-LL5-SST
LL 6	M 10 x 1	PN 100	12	11.5	0003102100	24-N-LL6	0003106000	24-N-LL6-SST
LL 8	M 12 x 1	PN 100	14	12	0003152100	24-N-LL8	0003156000	24-N-LL8-SST
L 6	M 12 x 1.5	PN 500	14	14.5	0004002100	24-N-L6	0004006000	24-N-L6-SST
L 8	M 14 x 1.5	PN 500	17	14.5	0004052100	24-N-L8	0004056000	24-N-L8-SST
L 10	M 16 x 1.5	PN 500	19	15.5	0004102100	24-N-L10	0004106000	24-N-L10-SST
L 12	M 18 x 1.5	PN 400	22	15.5	0004152100	24-N-L12	0004156000	24-N-L12-SST
L 15	M 22 x 1.5	PN 400	27	17	0004202100	24-N-L15	0004206000	24-N-L15-SST
L 18	M 26 x 1.5	PN 400	32	18	0004252100	24-N-L18	0004256000	24-N-L18-SST
L 22	M 30 x 2	PN 250	36	20	0004302100	24-N-L22	0004306000	24-N-L22-SST
L 28	M 36 x 2	PN 250	41	21	0004352100	24-N-L28	0004356000	24-N-L28-SST
L 35	M 45 x 2	PN 250	50	24	0004402100	24-N-L35	0004406000	24-N-L35-SST
L 42	M 52 x 2	PN 250	60	24	0004452100	24-N-L42	0004456000	24-N-L42-SST
S 6	M 14 x 1.5	PN 800	17	16.5	0004502100	24-N-S6	0004506000	24-N-S6-SST
S 8	M 16 x 1.5	PN 800	19	16.5	0004552100	24-N-S8	0004556000	24-N-S8-SST
S 10	M 18 x 1.5	PN 800	22	17.5	0004602100	24-N-S10	0004606000	24-N-S10-SST
S 12	M 20 x 1.5	PN 630	24	17.5	0004652100	24-N-S12	0004656000	24-N-S12-SST
S 14	M 22 x 1.5	PN 630	27	20.5	0004702100	24-N-S14	0004706000	24-N-S14-SST
S 16	M 24 x 1.5	PN 630	30	20.5	0004752100	24-N-S16	0004756000	24-N-S16-SST
S 20	M 30 x 2	PN 420	36	24	0004802100	24-N-S20	0004806000	24-N-S20-SST
S 25	M 36 x 2	PN 420	46	27	0004852100	24-N-S25	0004856000	24-N-S25-SST
S 30	M 42 x 2	PN 420	50	29	0004902100	24-N-S30	0004906000	24-N-S30-SST
S 38	M 52 x 2	PN 420	60	32.5	0004952100	24-N-S38	0004956000	24-N-S38-SST

To reduce the assembly forces, the union nuts are coated with wax lubricant.

Example for comp. :
M04LLX
DIN 3870-ALL4

M06LX
ISO 8434-1-N-L6-St



SQR-function nuts

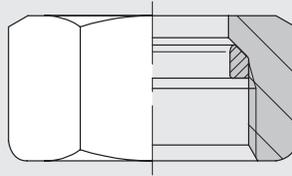

VOSSForm^{SQR}

Steel / stainless-steel set comprising

- SQR-function nuts
- moulded seals

Standard moulded-seal material is FPM/FKM

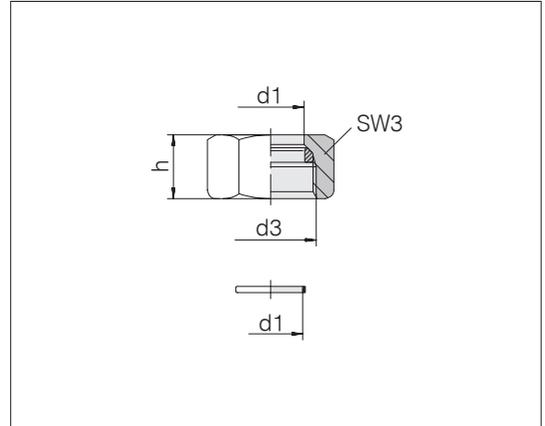

Series	d3	Pressure	SW3	h	kg/100 ca.	Order-No.	Designation steel	Order-No.	Designation stainless steel	
L	6	M 12 x 1.5	PN 500	14	14.5	1.1	0015502167	24-SQRNMS-L6-PU300	0015506067	24-SQRNMS-L6-SST-PU100
L	8	M 14 x 1.5	PN 500	17	14.5	1.7	0015512167	24-SQRNMS-L8-PU250	0015516067	24-SQRNMS-L8-SST-PU100
L	10	M 16 x 1.5	PN 500	19	15.5	2.0	0015522167	24-SQRNMS-L10-PU150	0015526067	24-SQRNMS-L10-SST-PU100
L	12	M 18 x 1.5	PN 400	22	15.5	2.8	0015532167	24-SQRNMS-L12-PU100	0015536067	24-SQRNMS-L12-SST-PU100
L	15	M 22 x 1.5	PN 400	27	17	4.7	0015542167	24-SQRNMS-L15-PU60	0015546067	24-SQRNMS-L15-SST-PU50
L	18	M 26 x 1.5	PN 400	32	18	6.9	0015552167	24-SQRNMS-L18-PU45	0015556067	24-SQRNMS-L18-SST-PU45
L	22	M 30 x 2	PN 250	36	20	8.9	0015562167	24-SQRNMS-L22-PU30	0015566067	24-SQRNMS-L22-SST-PU30
L	28	M 36 x 2	PN 250	41	21	9.4	0015572167	24-SQRNMS-L28-PU25	0015576067	24-SQRNMS-L28-SST-PU25
L	35	M 45 x 2	PN 250	50	24	15.0	0015582167	24-SQRNMS-L35-PU15	0015586067	24-SQRNMS-L35-SST-PU15
L	42	M 52 x 2	PN 250	60	24	23.0	0015592167	24-SQRNMS-L42-PU10	0015596067	24-SQRNMS-L42-SST-PU10
S	6	M 14 x 1.5	PN 800	17	16.5	2.0	0015602167	24-SQRNMS-S6-PU200	0015606067	24-SQRNMS-S6-SST-PU100
S	8	M 16 x 1.5	PN 800	19	16.5	2.3	0015612167	24-SQRNMS-S8-PU150	0015616067	24-SQRNMS-S8-SST-PU100
S	10	M 18 x 1.5	PN 800	22	17.5	3.5	0015622167	24-SQRNMS-S10-PU100	0015626067	24-SQRNMS-S10-SST-PU100
S	12	M 20 x 1.5	PN 630	24	17.5	3.9	0015632167	24-SQRNMS-S12-PU90	0015636067	24-SQRNMS-S12-SST-PU50
S	14	M 22 x 1.5	PN 630	27	20.5	5.8	0015642167	24-SQRNMS-S14-PU60	0015646067	24-SQRNMS-S14-SST-PU50
S	16	M 24 x 1.5	PN 630	30	20.5	7.1	0015652167	24-SQRNMS-S16-PU50	0015656067	24-SQRNMS-S16-SST-PU50
S	20	M 30 x 2	PN 420	36	24	11.3	0015662167	24-SQRNMS-S20-PU25	0015666067	24-SQRNMS-S20-SST-PU25
S	25	M 36 x 2	PN 420	46	27	21.2	0015672167	24-SQRNMS-S25-PU15	0015676067	24-SQRNMS-S25-SST-PU15
S	30	M 42 x 2	PN 420	50	29	23.3	0015682167	24-SQRNMS-S30-PU10	0015686067	24-SQRNMS-S30-SST-PU10
S	38	M 52 x 2	PN 420	60	32.5	34.4	0015692167	24-SQRNMS-S38-PU6	0015696067	24-SQRNMS-S38-SST-PU6

To reduce the assembly forces, the union nuts are coated with wax lubricant.

In the designation the suffix PU300 describes the minimum order quantity of 300 items.

BV-10 tube connecting parts

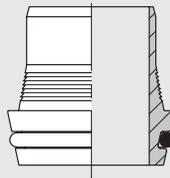
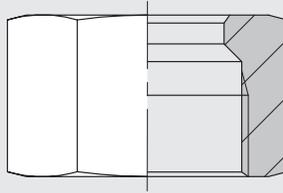

Flared cones

Standard O-ring material is NBR

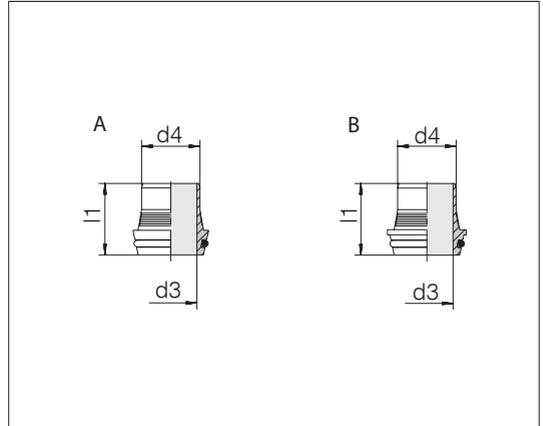

Series Tube d1 x s	Pressure	d3	d4	l1	Form	kg/100 ca.	Order-No.	Designation
L 6 x 1	PN 500	2.9	4.2	16.5	A	0.3	0034009900	24-BV10CO-L6x1-C19
L 8 x 1	PN 500	4.9	6.2	18.6	A	0.4	0034059900	24-BV10CO-L8x1-C19
L 10 x 1	PN 500	6.3	8.2	19	A	0.6	0034109900	24-BV10CO-L10x1-C19
L 10 x 1.5	PN 500	5.5	7.2	19	A	0.6	0034119900	24-BV10CO-L10x1,5-C19
L 12 x 1	PN 400	8	10.2	21.5	A	0.9	0034159900	24-BV10CO-L12x1-C19
L 12 x 1.5	PN 400	7.5	9.2	21.5	A	0.8	0034169900	24-BV10CO-L12x1,5-C19
L 15 x 1.5	PN 400	10.2	12.2	21.5	A	1.1	0034219900	24-BV10CO-L15x1,5-C19
L 15 x 2	PN 400	9.1	11.3	21.5	A	1.2	0034229900	24-BV10CO-L15x2-C19
L 18 x 1.5	PN 400	13	15.2	22	B	1.5	0034269900	24-BV10CO-L18x1,5-C19
L 18 x 2	PN 400	12	14.3	22	B	1.6	0034279900	24-BV10CO-L18x2-C19
L 22 x 1.5	PN 250	16.2	19.2	23.5	B	2.0	0034319900	24-BV10CO-L22x1,5-C19
L 22 x 2	PN 250	16.2	18.3	23.5	B	2.0	0034329900	24-BV10CO-L22x2-C19
L 28 x 2	PN 250	21	24.3	27	B	3.8	0034379900	24-BV10CO-L28x2-C19
L 28 x 3	PN 250	19.5	22.3	27	B	3.6	0034399900	24-BV10CO-L28x3-C19
L 35 x 2	PN 250	28.5	31.3	31	B	5.3	0034419900	24-BV10CO-L35x2-C19
L 35 x 3	PN 250	26.5	29.3	31	B	6.1	0034439900	24-BV10CO-L35x3-C19
L 42 x 3	PN 250	33.5	36.3	31	B	7.7	0034479900	24-BV10CO-L42x3-C19

Flared cones

Standard O-ring material is NBR

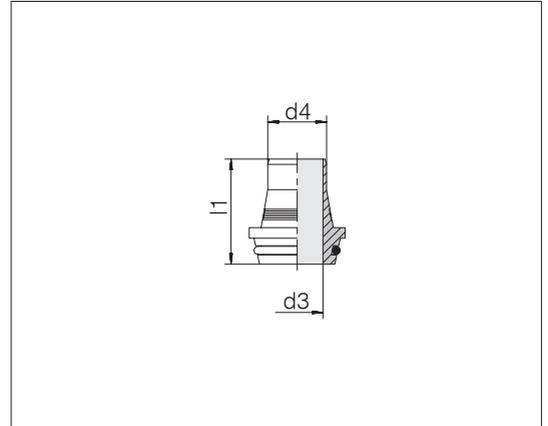

Series Tube d1 x s	Pressure	d3	d4	l1	kg/100 ca.	Order-No.	Designation
S 8 x 1.5	PN 800	4	5.2	20	0.5	0034569900	24-BV10CO-S8x1,5-C19
S 8 x 2	PN 800	3	4.2	20	0.5	0034579900	24-BV10CO-S8x2-C19
S 10 x 1.5	PN 800	5.5	7.2	21	0.8	0034619900	24-BV10CO-S10x1,5-C19
S 10 x 2	PN 800	4.5	6.2	21	0.8	0034629900	24-BV10CO-S10x2-C19
S 12 x 1.5	PN 630	7.5	9.2	22.5	1.0	0034669900	24-BV10CO-S12x1,5-C19
S 12 x 2	PN 630	6.5	8.2	22.5	1.1	0034679900	24-BV10CO-S12x2-C19
S 12 x 3	PN 630	4.5	6.2	22.5	1.1	0034699900	24-BV10CO-S12x3-C19
S 14 x 2	PN 630	8.5	10.3	26	1.5	0034719900	24-BV10CO-S14x2-C19
S 16 x 2	PN 630	10.5	12.3	26.5	1.8	0034779900	24-BV10CO-S16x2-C19
S 16 x 2.5	PN 630	9.5	11.3	26.5	1.6	0034789900	24-BV10CO-S16x2,5-C19
S 16 x 3	PN 630	8.5	10.3	26.5	1.8	0034799900	24-BV10CO-S16x3-C19
S 20 x 2	PN 420	13.5	16.3	32	3.4	0034819900	24-BV10CO-S20x2-C19
S 20 x 2.5	PN 420	13.5	15.3	32	3.3	0034829900	24-BV10CO-S20x2,5-C19
S 20 x 3	PN 420	12.5	14.3	32	3.5	0034839900	24-BV10CO-S20x3-C19
S 20 x 3.5	PN 420	11	13.3	32	3.1	0034849900	24-BV10CO-S20x3,5-C19
S 20 x 4	PN 420	10	12.3	32	3.1	0040049900	24-BV10CO-S20x4-C19
S 25 x 2.5	PN 420	18	20.3	34.5	5.9	0034869900	24-BV10CO-S25x2,5-C19
S 25 x 3	PN 420	17	19.3	34.5	6.1	0034879900	24-BV10CO-S25x3-C19
S 25 x 4	PN 420	15	17.3	34.5	6.5	0034889900	24-BV10CO-S25x4-C19
S 30 x 3	PN 420	22	24.3	34.5	6.8	0034929900	24-BV10CO-S30x3-C19
S 30 x 4	PN 420	20	22.3	34.5	7.4	0034939900	24-BV10CO-S30x4-C19
S 30 x 5	PN 420	17	20.3	34.5	8.5	0034949900	24-BV10CO-S30x5-C19
S 38 x 3	PN 420	30	32.3	38	8.9	0034969900	24-BV10CO-S38x3-C19
S 38 x 4	PN 420	27	30.3	38	12.8	0034979900	24-BV10CO-S38x4-C19
S 38 x 5	PN 420	26	28.3	38	12.0	0034989900	24-BV10CO-S38x5-C19
S 38 x 6	PN 420	23	26.3	38	11.8	0034999900	24-BV10CO-S38x6-C19

Clamping rings

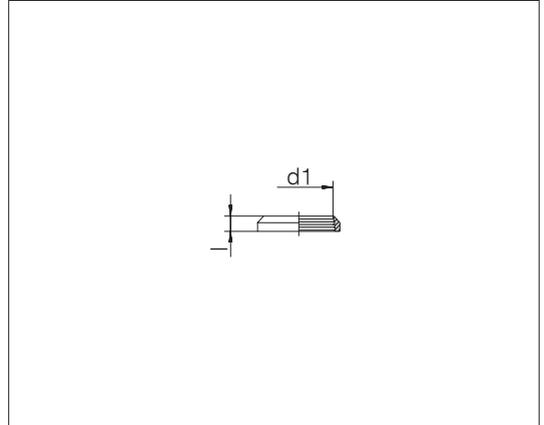

Series	Tube OD	Pressure	l	kg/100 ca.	Order-No.	Designation
L	6	PN 500	3.8	0.1	0031001900	24-BV10R-L6-C19
L	8	PN 500	3.8	0.1	0031051900	24-BV10R-L8-C19
L	10	PN 500	3.8	0.1	0031101900	24-BV10R-L10-C19
L	12	PN 400	3.8	0.2	0031151900	24-BV10R-L12-C19
L	15	PN 400	4.5	0.3	0031201900	24-BV10R-L15-C19
L	18	PN 400	4.5	0.4	0031251900	24-BV10R-L18-C19
L	22	PN 250	5	0.5	0031301900	24-BV10R-L22-C19
L	28	PN 250	5.5	0.5	0031351900	24-BV10R-L28-C19
L	35	PN 250	7	1.4	0031401900	24-BV10R-L35-C19
L	42	PN 250	7	1.6	0031451900	24-BV10R-L42-C19
S	8	PN 800	4.5	0.3	0031551900	24-BV10R-S8-C19
S	10	PN 800	4.5	0.3	0031601900	24-BV10R-S10-C19
S	12	PN 630	4.5	0.3	0031651900	24-BV10R-S12-C19
S	14	PN 630	6.5	0.5	0031701900	24-BV10R-S14-C19
S	16	PN 630	6.5	0.6	0031751900	24-BV10R-S16-C19
S	20	PN 420	9	1.1	0031801900	24-BV10R-S20-C19
S	25	PN 420	10	2.3	0031851900	24-BV10R-S25-C19
S	30	PN 420	10	2.6	0031901900	24-BV10R-S30-C19
S	38	PN 420	13.5	5.7	0031951900	24-BV10R-S38-C19

BV-10 union nuts

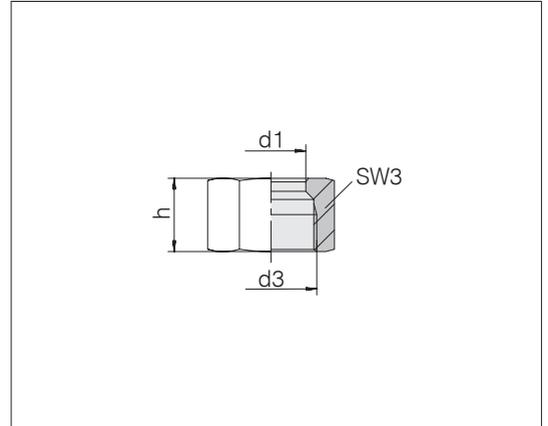

Series	Tube OD	d3	Pressure	SW3	h	kg/100 ca.	Order-No.	Designation
L	6	M 12 x 1.5	PN 500	14	17.8	1.2	0032002100	24-BV10N-L6
L	8	M 14 x 1.5	PN 500	17	17.8	1.8	0032052100	24-BV10N-L8
L	10	M 16 x 1.5	PN 500	19	18.8	2.2	0032102100	24-BV10N-L10
L	12	M 18 x 1.5	PN 400	22	18.8	3.1	0032152100	24-BV10N-L12
L	15	M 22 x 1.5	PN 400	27	20.3	5.0	0032202100	24-BV10N-L15
L	18	M 26 x 1.5	PN 400	32	21.3	7.5	0032252100	24-BV10N-L18
L	22	M 30 x 2	PN 250	36	24	9.9	0032302100	24-BV10N-L22
L	28	M 36 x 2	PN 250	41	25	11.2	0032352100	24-BV10N-L28
L	35	M 45 x 2	PN 250	50	28	17.2	0032402100	24-BV10N-L35
L	42	M 52 x 2	PN 250	60	28	26.7	0032452100	24-BV10N-L42
S	8	M 16 x 1.5	PN 800	19	20	2.5	0032552100	24-BV10N-S8
S	10	M 18 x 1.5	PN 800	22	21.5	3.7	0032602100	24-BV10N-S10
S	12	M 20 x 1.5	PN 630	24	21.5	4.1	0032652100	24-BV10N-S12
S	14	M 22 x 1.5	PN 630	27	26	6.5	0032702100	24-BV10N-S14
S	16	M 24 x 1.5	PN 630	30	26	8.1	0032752100	24-BV10N-S16
S	20	M 30 x 2	PN 420	36	30.5	12.6	0032802100	24-BV10N-S20
S	25	M 36 x 2	PN 420	46	38	28.4	0032852100	24-BV10N-S25
S	30	M 42 x 2	PN 420	50	39	29.5	0032902100	24-BV10N-S30
S	38	M 52 x 2	PN 420	60	46	45.2	0032952100	24-BV10N-S38

Flared connecting parts

Standard O-ring material is NBR

L series, complete

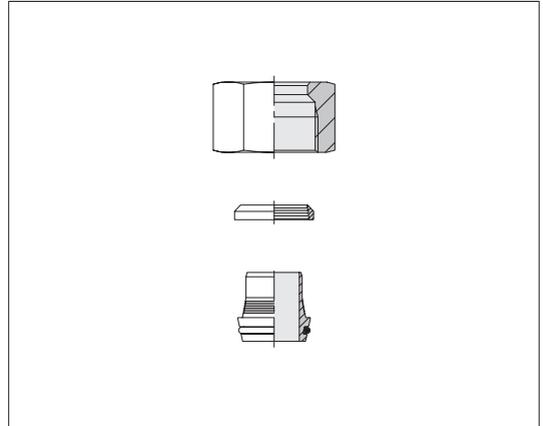

Series Tube d1 x s	Pressure	kg/100 ca.	Order-No.	Designation
L 6 x 1	PN 500	1.6	0033009900	24-BV10SO-L6x1-C19
L 8 x 1	PN 500	2.3	0033059900	24-BV10SO-L8x1-C19
L 10 x 1	PN 500	2.9	0033109900	24-BV10SO-L10x1-C19
L 10 x 1.5	PN 500	2.9	0033119900	24-BV10SO-L10x1,5-C19
L 12 x 1	PN 400	4.2	0033159900	24-BV10SO-L12x1-C19
L 12 x 1.5	PN 400	4.2	0033169900	24-BV10SO-L12x1,5-C19
L 15 x 1.5	PN 400	6.4	0033219900	24-BV10SO-L15x1,5-C19
L 15 x 2	PN 400	6.4	0033229900	24-BV10SO-L15x2-C19
L 18 x 1.5	PN 400	9.4	0033269900	24-BV10SO-L18x1,5-C19
L 18 x 2	PN 400	9.5	0033279900	24-BV10SO-L18x2-C19
L 22 x 1.5	PN 250	12.4	0033319900	24-BV10SO-L22x1,5-C19
L 22 x 2	PN 250	12.4	0033329900	24-BV10SO-L22x2-C19
L 28 x 2	PN 250	15.5	0033379900	24-BV10SO-L28x2-C19
L 28 x 3	PN 250	15.3	0033399900	24-BV10SO-L28x3-C19
L 35 x 2	PN 250	23.9	0033419900	24-BV10SO-L35x2-C19
L 35 x 3	PN 250	24.7	0033439900	24-BV10SO-L35x3-C19
L 42 x 3	PN 250	36.0	0033479900	24-BV10SO-L42x3-C19

Flared connecting parts

Standard O-ring material is NBR

S series, complete

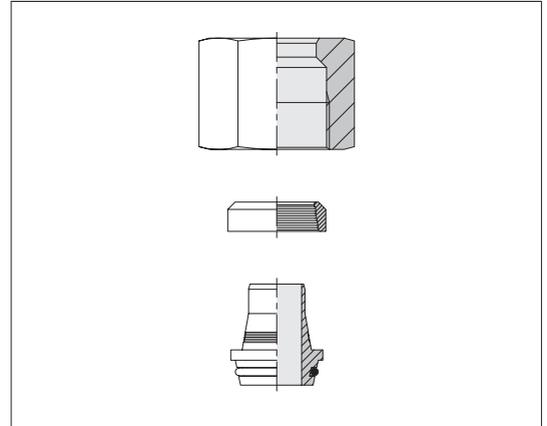

Series Tube d1 x s	Pressure	kg/100 ca.	Order-No.	Designation
S 8 x 1.5	PN 800	4.8	0033569900	24-BV10SO-S8x1,5-C19
S 8 x 2	PN 800	5.0	0033579900	24-BV10SO-S8x2-C19
S 10 x 1.5	PN 800	5.6	0033619900	24-BV10SO-S10x1,5-C19
S 10 x 2	PN 800	5.6	0033629900	24-BV10SO-S10x2-C19
S 12 x 1.5	PN 630	6.5	0033669900	24-BV10SO-S12x1,5-C19
S 12 x 2	PN 630	6.6	0033679900	24-BV10SO-S12x2-C19
S 12 x 3	PN 630	6.7	0033699900	24-BV10SO-S12x3-C19
S 14 x 2	PN 630	10.3	0033719900	24-BV10SO-S14x2-C19
S 16 x 2	PN 630	11.0	0033779900	24-BV10SO-S16x2-C19
S 16 x 2.5	PN 630	11.0	0033789900	24-BV10SO-S16x2,5-C19
S 16 x 3	PN 630	11.4	0033799900	24-BV10SO-S16x3-C19
S 20 x 2	PN 420	15.7	0033819900	24-BV10SO-S20x2-C19
S 20 x 2.5	PN 420	15.7	0033829900	24-BV10SO-S20x2,5-C19
S 20 x 3	PN 420	15.7	0033839900	24-BV10SO-S20x3-C19
S 20 x 3.5	PN 420	15.7	0033849900	24-BV10SO-S20x3,5-C19
S 20 x 4	PN 420	15.5	0033859900	24-BV10SO-S20x4-C19
S 25 x 2.5	PN 420	25.3	0033869900	24-BV10SO-S25x2,5-C19
S 25 x 3	PN 420	25.3	0033879900	24-BV10SO-S25x3-C19
S 25 x 4	PN 420	25.5	0033889900	24-BV10SO-S25x4-C19
S 30 x 3	PN 420	37.5	0033929900	24-BV10SO-S30x3-C19
S 30 x 4	PN 420	38.0	0033939900	24-BV10SO-S30x4-C19
S 30 x 5	PN 420	39.2	0033949900	24-BV10SO-S30x5-C19
S 38 x 3	PN 420	60.0	0033969900	24-BV10SO-S38x3-C19
S 38 x 4	PN 420	61.7	0033979900	24-BV10SO-S38x4-C19
S 38 x 5	PN 420	62.2	0033989900	24-BV10SO-S38x5-C19
S 38 x 6	PN 420	62.3	0033999900	24-BV10SO-S38x6-C19

24/37° tube connecting parts

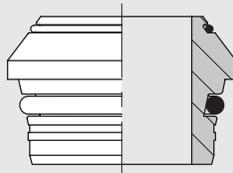
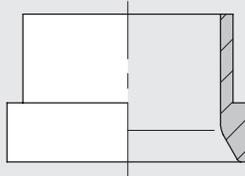
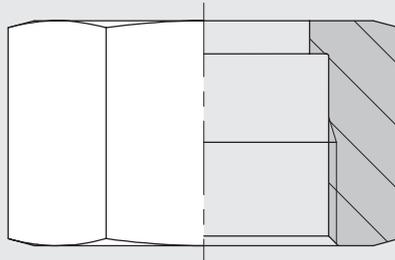

24/37° adapter rings

Standard O-ring material is FPM/FKM

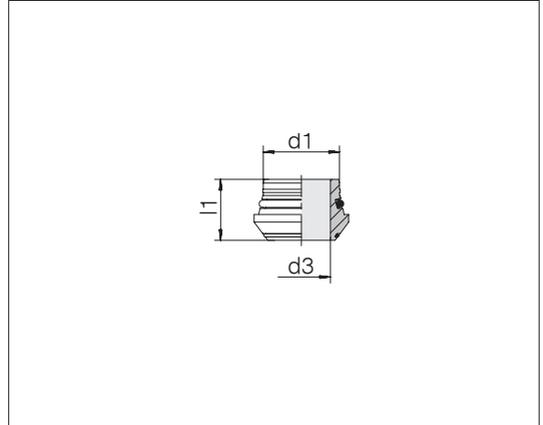

Series	Pressure	d3	l1	kg/100 ca.	Order-No.	Designation
Tube OD d1						
L/S 6	PN 500/630	3	11.5	0.3	0041002158	24-24/37AO-L/S6-C21
L/S 8	PN 500/630	5	12	0.4	0041012158	24-24/37AO-L/S8-C21
L/S 10	PN 500/630	6	12.5	0.6	0041022158	24-24/37AO-L/S10-C21
L/S 12	PN 400/630	8	12.5	0.8	0041032158	24-24/37AO-L/S12-C21
L 15	PN 400	11	12.5	1.0	0041042158	24-24/37AO-L15-C21
L 18	PN 400	14	13	1.3	0041052158	24-24/37AO-L18-C21
L 22	PN 250	17	14.2	2.1	0041062158	24-24/37AO-L22-C21
L 28	PN 250	23	14.7	2.9	0041072158	24-24/37AO-L28-C21
L 35	PN 250	28	18.5	6.1	0041082158	24-24/37AO-L35-C21
L 42	PN 250	35	20.5	8.1	0041092158	24-24/37AO-L42-C21
S 14	PN 630	9	14	1.2	0041102158	24-24/37AO-S14-C21
S 16	PN 630	11	15	1.5	0041112158	24-24/37AO-S16-C21
S 20	PN 400	14	18.5	2.8	0041122158	24-24/37AO-S20-C21
S 25	PN 400	19	20	4.0	0041132158	24-24/37AO-S25-C21
S 30	PN 400	23	22	6.0	0041142158	24-24/37AO-S30-C21
S 38	PN 400	30	26	9.3	0041152158	24-24/37AO-S38-C21

Weight without O-ring.

24/37° support sleeves

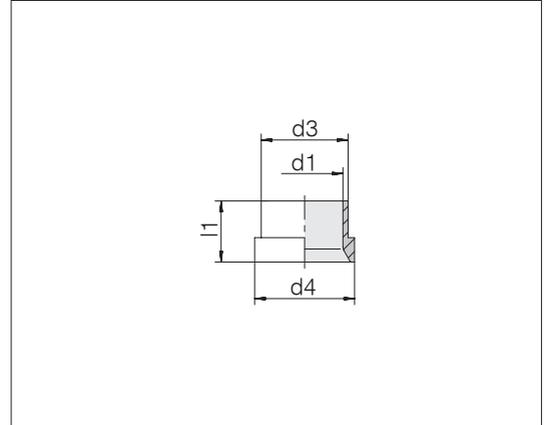

Series	Tube OD	Pressure	d3	d4	l1	kg/100 ca.	Order-No.	Designation
L/S	6	PN 500/630	7.6	10.2	10.5	0.2	0041202000	24-24/37R-L/S6
L/S	8	PN 500/630	9.3	12.2	11	0.3	0041212000	24-24/37R-L/S8
L/S	10	PN 500/630	11.5	14.2	12.5	0.4	0041222000	24-24/37R-L/S10
L/S	12	PN 400/630	13.6	16.2	13	0.5	0041232000	24-24/37R-L/S12
L	15	PN 400	17.5	20.2	14	1.0	0041242000	24-24/37R-L15
L	18	PN 400	21	24.2	14.5	1.5	0041252000	24-24/37R-L18
L	22	PN 250	24.2	27.8	18	1.7	0041262000	24-24/37R-L22
L	28	PN 250	30.2	33.8	17	2.0	0041272000	24-24/37R-L28
L	35	PN 250	38	42.7	19	3.8	0041282000	24-24/37R-L35
L	42	PN 250	45	49.7	21	5.2	0041292000	24-24/37R-L42
S	14	PN 630	17.5	20.2	14.5	1.2	0041302000	24-24/37R-S14
S	16	PN 630	18.5	22	17	1.3	0041312000	24-24/37R-S16
S	20	PN 400	24.2	27.8	17.5	2.5	0041322000	24-24/37R-S20
S	25	PN 400	28.5	32.8	20	3.2	0041332000	24-24/37R-S25
S	30	PN 400	34	39	21.5	4.9	0041342000	24-24/37R-S30
S	38	PN 400	42	48.5	26.5	7.7	0041352000	24-24/37R-S38

24/37° union nuts

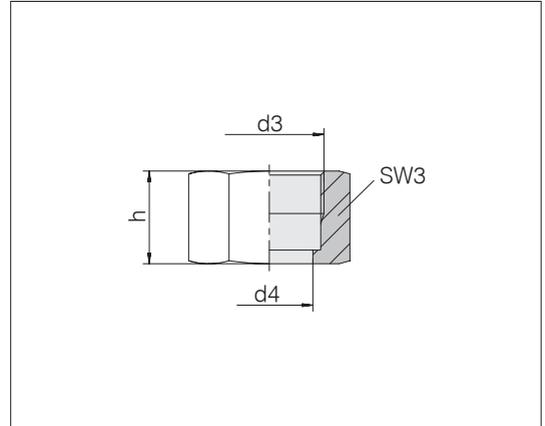

Series Tube OD	d3	Pressure	d4	SW3	h	kg/100 ca.	Order-No.	Designation
L 6	M 12 x 1.5	PN 500	7.8	14	17	1.2	0041402100	24-24/37N-L6
L 8	M 14 x 1.5	PN 500	9.5	17	18	1.9	0041412100	24-24/37N-L8
L 10	M 16 x 1.5	PN 500	11.7	19	19.5	2.4	0041422100	24-24/37N-L10
L 12	M 18 x 1.5	PN 400	13.8	22	20.5	3.5	0041432100	24-24/37N-L12
L 15	M 22 x 1.5	PN 630	17.7	27	23	5.7	0041442100	24-24/37N-L15-S14
L 18	M 26 x 1.5	PN 400	21.2	32	23	7.9	0041452100	24-24/37N-L18
L 22	M 30 x 2	PN 400	24.4	36	27.5	11.5	0041462100	24-24/37N-L22-S20
L 28	M 36 x 2	PN 250	30.4	41	27.5	12.5	0041472100	24-24/37N-L28
L 35	M 45 x 2	PN 250	38.3	50	30	17.9	0041482100	24-24/37N-L35
L 42	M 52 x 2	PN 250	45.3	60	34	32.4	0041492100	24-24/37N-L42
S 6	M 14 x 1.5	PN 630	7.8	17	18	2.0	0041502100	24-24/37N-S6
S 8	M 16 x 1.5	PN 630	9.5	19	19	2.4	0041512100	24-24/37N-S8
S 10	M 18 x 1.5	PN 630	11.7	22	20.5	3.6	0041522100	24-24/37N-S10
S 12	M 20 x 1.5	PN 630	13.8	24	21	4.1	0041532100	24-24/37N-S12
S 14	M 22 x 1.5	PN 630	17.7	27	23	5.7	0041442100	24-24/37N-L15-S14
S 16	M 24 x 1.5	PN 630	18.7	30	26.5	8.4	0041542100	24-24/37N-S16
S 20	M 30 x 2	PN 400	24.4	36	27.5	11.5	0041462100	24-24/37N-L22-S20
S 25	M 36 x 2	PN 400	28.7	46	30.5	23.1	0041552100	24-24/37N-S25
S 30	M 42 x 2	PN 400	34.2	50	32	24.1	0041562100	24-24/37N-S30
S 38	M 52 x 2	PN 400	42.3	60	38	37.0	0041572100	24-24/37N-S38

24/37° flared connecting parts

Standard O-ring material is FPM/FKM

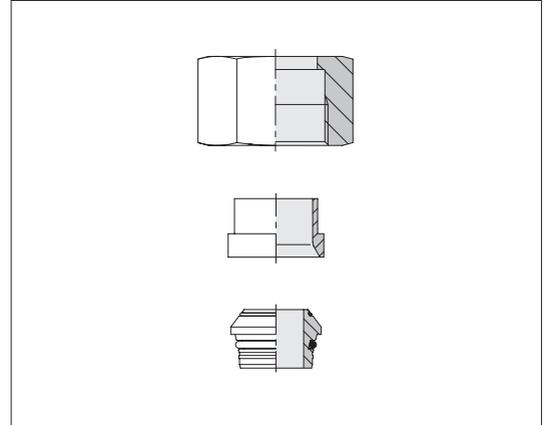

Series Tube OD	Pressure	kg/100 ca.	Order-No.	Designation
L 6	PN 500	1.7	0041602058	24-24/37SO-L6
L 8	PN 500	2.6	0041612058	24-24/37SO-L8
L 10	PN 500	3.4	0041622058	24-24/37SO-L10
L 12	PN 400	4.8	0041632058	24-24/37SO-L12
L 15	PN 400	7.7	0041642058	24-24/37SO-L15
L 18	PN 400	10.7	0041652058	24-24/37SO-L18
L 22	PN 250	15.3	0041662058	24-24/37SO-L22
L 28	PN 250	17.4	0041672058	24-24/37SO-L28
L 35	PN 250	27.8	0041682058	24-24/37SO-L35
L 42	PN 250	45.7	0041692058	24-24/37SO-L42
S 6	PN 630	2.5	0041702058	24-24/37SO-S6
S 8	PN 630	3.1	0041712058	24-24/37SO-S8
S 10	PN 630	4.6	0041722058	24-24/37SO-S10
S 12	PN 630	5.4	0041732058	24-24/37SO-S12
S 14	PN 630	8.1	0041742058	24-24/37SO-S14
S 16	PN 630	11.2	0041752058	24-24/37SO-S16
S 20	PN 400	16.8	0041762058	24-24/37SO-S20
S 25	PN 400	30.3	0041772058	24-24/37SO-S25
S 30	PN 400	35.0	0041782058	24-24/37SO-S30
S 38	PN 400	54.0	0041792058	24-24/37SO-S38

Male stud couplings

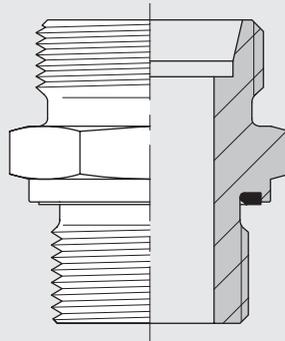

Straight male stud couplings

Male thread: metric fine thread, tapered

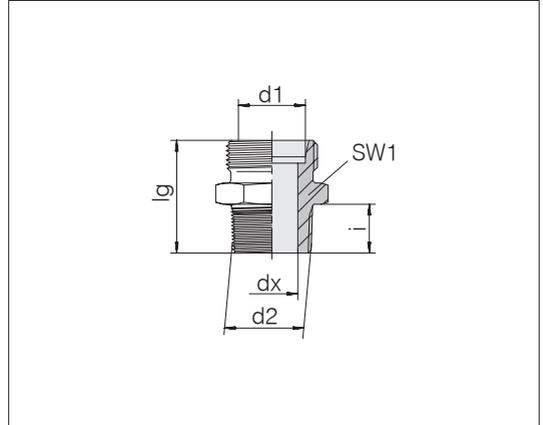

Series	d2	Pressure	dx	lg	SW1	i	kg/100 ca.	Order-No.	Designation
Tube OD d1									
LL 4	M 6 x 1 keg	PN 100	2	20	9	8	0.6	0701012000	24-SDS-LL4-M6T
LL 4	M 8 x 1 keg	PN 100	3	20	10	8	0.6	0701002000	24-SDS-LL4-M8T
LL 4	M 10 x 1 keg	PN 100	3	20	11	8	0.8	0701022000	24-SDS-LL4-M10T
LL 5	M 8 x 1 keg	PN 100	3.5	20	11	8	0.6	0701052000	24-SDS-LL5-M8T
LL 6	M 6 x 1 keg	PN 100	2.5	20	11	8	0.6	0701982000	24-SDS-LL6-M6T
LL 6	M 8 x 1 keg	PN 100	4.5	20	11	8	0.6	0701112000	24-SDS-LL6-M8T
LL 6	M 10 x 1 keg	PN 100	4.5	20	11	8	0.8	0701102000	24-SDS-LL6-M10T
LL 8	M 10 x 1 keg	PN 100	6	22	12	8	1.0	0701152000	24-SDS-LL8-M10T
L 6	M 10 x 1 keg	PN 315	4	22	14	8	1.3	0702002000	24-SDS-L6-M10T
L 8	M 10 x 1 keg	PN 315	4	23	17	8	2.0	0702072000	24-SDS-L8-M10T
L 8	M 12 x 1.5 keg	PN 315	6	27	17	12	2.1	0702052000	24-SDS-L8-M12T
L 10	M 14 x 1.5 keg	PN 315	8	28	17	12	2.5	0702102000	24-SDS-L10-M14T
L 12	M 16 x 1.5 keg	PN 315	10	29	19	12	3.2	0702152000	24-SDS-L12-M16T
L 15	M 18 x 1.5 keg	PN 315	12	30	24	12	4.7	0702202000	24-SDS-L15-M18T
L 18	M 22 x 1.5 keg	PN 315	15	33	27	14	6.8	0702252000	24-SDS-L18-M22T
L 18	M 24 x 1.5 keg	PN 315	15	35	27	16	7.7	0702262000	24-SDS-L18-M24T
S 6	M 12 x 1.5 keg	PB 630	4	30	17	12	2.8	0702502000	24-SDS-S6-M12T
S 8	M 14 x 1.5 keg	PB 630	5	32	17	12	3.7	0702552000	24-SDS-S8-M14T
S 10	M 16 x 1.5 keg	PB 630	7	32	19	12	4.3	0702602000	24-SDS-S10-M16T
S 12	M 18 x 1.5 keg	PB 630	8	34	22	12	6.0	0702652000	24-SDS-S12-M18T
S 14	M 20 x 1.5 keg	PB 630	10	38	27	14	8.7	0702702000	24-SDS-S14-M20T
S 16	M 22 x 1.5 keg	PB 400	12	38	27	14	9.0	0702752000	24-SDS-S16-M22T

● Standard size

Operating pressure PB 630 only
applies if holes with
female conical threads are available.

Example for comp. :
GE06LMX
DIN 2353-AL6-St



Straight male stud couplings

Male thread: Whitworth pipe thread, tapered

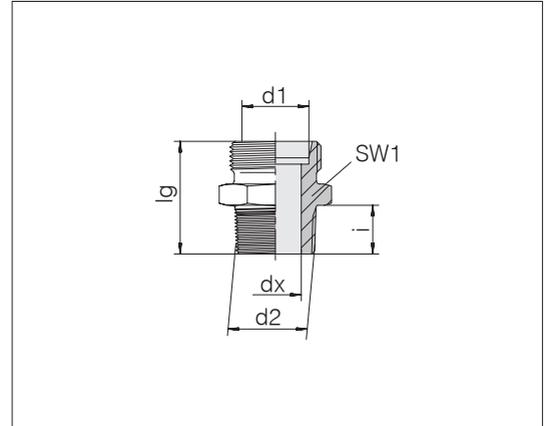

Series	Tube OD	d2	Pressure	dx	lg	SW1	i	kg/100 ca.	Order-No.	Designation	
LL	4	R 1/8	PN 100	3	20	10	8	0.8	0703002000	24-SDS-LL4-R1/8T	•
LL	5	R 1/8	PN 100	3.5	20	11	8	0.9	0703052000	24-SDS-LL5-R1/8T	•
LL	6	R 1/8	PN 100	4.5	20	11	8	0.8	0703102000	24-SDS-LL6-R1/8T	•
LL	6	R 1/4	PN 100	4.5	25	14	12	2.0	0703112000	24-SDS-LL6-R1/4T	
LL	8	R 1/8	PN 100	6	22	12	8	0.9	0703152000	24-SDS-LL8-R1/8T	•
LL	8	R 1/4	PN 100	6	26	14	12	1.7	0703172000	24-SDS-LL8-R1/4T	
L	6	R 1/8	PN 315	4	22	14	8	1.2	0704002000	24-SDS-L6-R1/8T	•
L	6	R 1/4	PN 315	4	26	14	12	1.9	0704022000	24-SDS-L6-R1/4T	
L	6	R 3/8	PN 315	4	28	19	12	3.6	0704032000	24-SDS-L6-R3/8T	
L	8	R 1/8	PN 315	4	23	14	8	1.5	0704062000	24-SDS-L8-R1/8T	
L	8	R 1/4	PN 315	6	27	17	12	2.2	0704052000	24-SDS-L8-R1/4T	•
L	8	R 3/8	PN 315	6	28	19	12	3.4	0704072000	24-SDS-L8-R3/8T	
L	8	R 1/2	PN 315	6	30	24	14	5.9	0704082000	24-SDS-L8-R1/2T	
L	10	R 1/4	PN 315	7	28	17	12	2.3	0704102000	24-SDS-L10-R1/4T	•
L	10	R 3/8	PN 315	8	28	19	12	3.1	0704122000	24-SDS-L10-R3/8T	
L	10	R 1/2	PN 315	8	31	24	14	5.6	0704132000	24-SDS-L10-R1/2T	
L	12	R 1/4	PN 315	7	29	19	12	2.8	0704162000	24-SDS-L12-R1/4T	
L	12	R 3/8	PN 315	9	29	19	12	3.3	0704152000	24-SDS-L12-R3/8T	•
L	12	R 1/2	PN 315	9	31	24	14	5.5	0704172000	24-SDS-L12-R1/2T	
L	12	R 3/4	PN 315	9	34	30	16	8.2	0704182000	24-SDS-L12-R3/4T	
L	15	R 1/4	PN 315	7	30	24	12	4.4	0704232000	24-SDS-L15-R1/4T	
L	15	R 3/8	PN 315	11	30	24	12	4.4	0704212000	24-SDS-L15-R3/8T	
L	15	R 1/2	PN 315	11	32	24	14	5.8	0704202000	24-SDS-L15-R1/2T	•
L	18	R 1/2	PN 315	14	33	27	14	6.4	0704252000	24-SDS-L18-R1/2T	•
L	18	R 3/4	PN 315	14	35	30	16	10.9	0704272000	24-SDS-L18-R3/4T	
L	22	R 1/2	PB 160	14	35	32	14	8.1	0704312000	24-SDS-L22-R1/2T	
L	22	R 3/4	PB 160	18	37	32	16	9.6	0704302000	24-SDS-L22-R3/4T	•
L	28	R 3/4	PB 160	18	38	41	16	13.9	0704362000	24-SDS-L28-R3/4T	
L	28	R 1	PB 160	23	40	41	18	15.6	0704352000	24-SDS-L28-R1T	•

• Standard size

Example for comp.:
GE06LFX
DIN 2353-BL6-St

Continued on following page

Straight male stud couplings

Male thread: Whitworth pipe thread, tapered

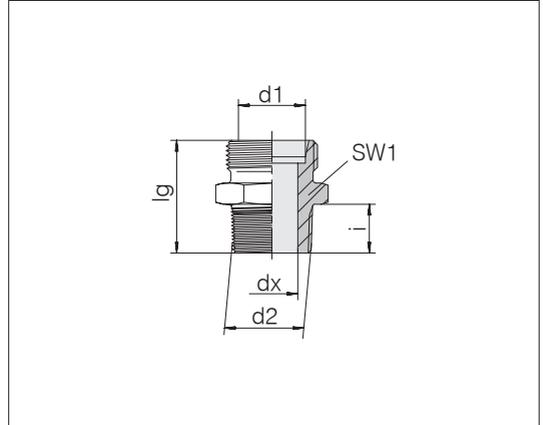

Series	d2	Pressure	dx	lg	SW1	i	kg/100 ca.	Order-No.	Designation
Tube OD d1									
S 6	R 1/4	PB 630	4	30	17	12	3.0	0704502000	24-SDS-S6-R1/4T •
S 8	R 1/4	PB 630	5	32	17	12	3.4	0704552000	24-SDS-S8-R1/4T •
S 10	R 3/8	PB 630	7	32	19	12	4.4	0704602000	24-SDS-S10-R3/8T •
S 12	R 1/4	PB 630	6	34	22	12	5.4	0704662000	24-SDS-S12-R1/4T •
S 12	R 3/8	PB 630	8	34	22	12	5.8	0704652000	24-SDS-S12-R3/8T •
S 14	R 3/8	PB 630	8	36	24	12	6.8	0704712000	24-SDS-S14-R3/8T •
S 14	R 1/2	PB 630	10	38	27	14	8.9	0704702000	24-SDS-S14-R1/2T •
S 16	R 3/8	PB 400	9	36	27	12	7.9	0704762000	24-SDS-S16-R3/8T •
S 16	R 1/2	PB 400	12	38	27	14	8.5	0704752000	24-SDS-S16-R1/2T •
S 20	R 1/2	PB 400	14	42	32	14	12.2	0704812000	24-SDS-S20-R1/2T •
S 20	R 3/4	PB 400	16	44	32	16	14.1	0704802000	24-SDS-S20-R3/4T •

• Standard size

Operating pressure PB 630 only
applies if holes with
female conical threads are available.



Straight male stud couplings

Male thread: NPT (ANSI/ASME B 1 - 20.01.1983)

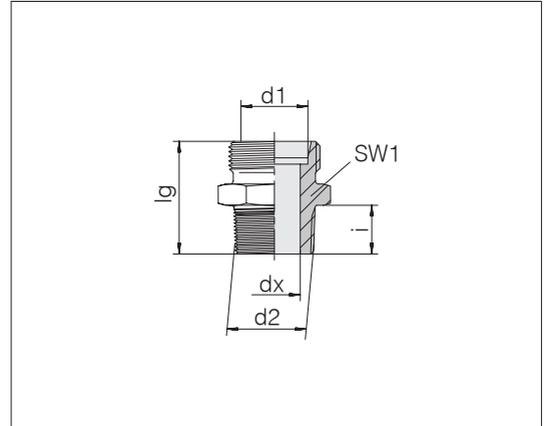

Series	d2	Pressure	dx	lg	SW1	i	Nm -10 %	kg/100 ca.	Order-No.	Designation		
LL	4	1/8 NPT	PN 100	3	21.9	11	9.9	15	0.9	0705002000	24-SDS-LL4-N1/8T	•
LL	6	1/8 NPT	PN 100	4.5	21.9	11	9.9	15	0.9	0705102000	24-SDS-LL6-N1/8T	•
LL	8	1/8 NPT	PN 100	6	23.9	12	9.9	15	1.0	0705152000	24-SDS-LL8-N1/8T	•
L	6	1/8 NPT	PN 315	4	23.9	12	9.9	15	1.2	0706002000	24-SDS-L6-N1/8T	•
L	6	1/4 NPT	PN 315	4	30	17	15.1	35	2.6	0706022000	24-SDS-L6-N1/4T	
L	8	1/8 NPT	PN 315	5	24.9	14	9.9	15	1.5	0706062000	24-SDS-L8-N1/8T	
L	8	1/4 NPT	PN 315	6	30.1	17	15.1	35	2.5	0706052000	24-SDS-L8-N1/4T	•
L	8	3/8 NPT	PN 315	6	31.2	19	15.2	55	3.9	0706072000	24-SDS-L8-N3/8T	
L	8	1/2 NPT	PN 315	6	38.5	24	19.8	110	7.1	0706082000	24-SDS-L8-N1/2T	
L	10	1/8 NPT	PN 315	4	27	17	9.9	15	2.3	0706112000	24-SDS-L10-N1/8T	
L	10	1/4 NPT	PN 315	7	31.1	17	15.1	35	2.5	0706102000	24-SDS-L10-N1/4T	•
L	10	3/8 NPT	PN 315	8	32.2	19	15.2	55	3.7	0706122000	24-SDS-L10-N3/8T	
L	10	1/2 NPT	PN 315	8	37.8	24	19.8	110	7.2	0706132000	24-SDS-L10-N1/2T	
L	12	1/4 NPT	PN 315	7	32	19	15.1	35	3.2	0706162000	24-SDS-L12-N1/4T	
L	12	3/8 NPT	PN 315	9	32.2	19	15.2	55	3.6	0706152000	24-SDS-L12-N3/8T	•
L	12	1/2 NPT	PN 315	10	36.8	24	19.8	110	6.4	0706172000	24-SDS-L12-N1/2T	
L	15	3/8 NPT	PN 315	9	33.2	24	15.2	55	5.2	0706212000	24-SDS-L15-N3/8T	
L	15	1/2 NPT	PN 315	11	37.8	24	19.8	110	6.8	0706202000	24-SDS-L15-N1/2T	•
L	18	3/8 NPT	PN 315	9	34.2	27	15.2	55	8.0	0706262000	24-SDS-L18-N3/8T	
L	18	1/2 NPT	PN 315	14	38.8	27	19.8	110	7.2	0706252000	24-SDS-L18-N1/2T	•
L	18	3/4 NPT	PN 160	14	39.1	30	20.1	175	9.1	0706272000	24-SDS-L18-N3/4T	
L	22	1/2 NPT	PN 160	14	40.8	32	19.8	110	9.9	0706312000	24-SDS-L22-N1/2T	
L	22	3/4 NPT	PN 160	18	41.1	32	20.1	175	10.1	0706302000	24-SDS-L22-N3/4T	•
L	28	1 NPT	PN 160	23	47	41	25	265	17.2	0706352000	24-SDS-L28-N1T	•
L	35	1 1/4 NPT	PN 160	30	50.6	46	25.6	315	25.6	0706402000	24-SDS-L35-N11/4T	•
L	42	1 1/2 NPT	PN 160	36	53	55	26	385	35.2	0706452000	24-SDS-L42-N11/2T	•

• Standard size

Example for comp.:
GE06L1/8NPTX

Continued on following page

Straight male stud couplings

Male thread: NPT (ANSI/ASME B 1 - 20.01.1983)

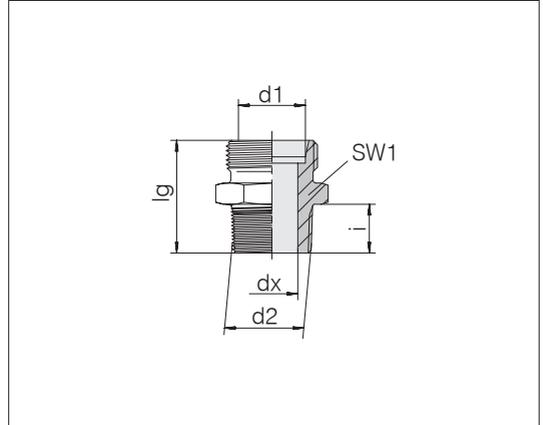

Series	d2	Pressure	dx	lg	SW1	i	Nm -10 %	kg/100 ca.	Order-No.	Designation	
Tube OD d1											
S 6	1/4 NPT	PN 630	4	33.1	17	15.1	35	3.3	0706502000	24-SDS-S6-N1/4T	•
S 8	1/4 NPT	PN 630	5	35.1	17	15.1	35	3.8	0706552000	24-SDS-S8-N1/4T	•
S 8	3/8 NPT	PN 630	5	35	19	15.2	55	4.5	0706572000	24-SDS-S8-N3/8T	
S 10	1/8 NPT	PN 630	4	30.9	19	9.9	15	4.0	0706632000	24-SDS-S10-N1/8T	
S 10	1/4 NPT	PN 630	5	35.1	19	15.1	35	4.3	0706612000	24-SDS-S10-N1/4T	
S 10	3/8 NPT	PN 630	7	35.2	19	15.2	55	4.8	0706602000	24-SDS-S10-N3/8T	•
S 10	1/2 NPT	PN 630	7	41.8	24	19.8	110	9.0	0706622000	24-SDS-S10-N1/2T	
S 12	1/4 NPT	PN 630	5	37.1	22	15.1	35	5.8	0706662000	24-SDS-S12-N1/4T	
S 12	3/8 NPT	PN 630	8	37.2	22	15.2	55	6.2	0706652000	24-SDS-S12-N3/8T	•
S 12	1/2 NPT	PN 630	8	41.8	24	19.8	110	9.0	0706672000	24-SDS-S12-N1/2T	
S 14	3/8 NPT	PN 630	8	39	24	15.2	55	7.2	0706712000	24-SDS-S14-N3/8T	
S 14	1/2 NPT	PN 630	10	43.8	27	19.8	110	9.9	0706702000	24-SDS-S14-N1/2T	•
S 16	3/8 NPT	PN 400	8	39.2	27	15.2	55	8.4	0706762000	24-SDS-S16-N3/8T	
S 16	1/2 NPT	PN 400	12	43.8	27	19.8	110	9.4	0706752000	24-SDS-S16-N1/2T	•
S 16	3/4 NPT	PN 400	12	44	30	20.1	175	13.5	0706772000	24-SDS-S16-N3/4T	
S 20	1/2 NPT	PN 400	14	47.8	32	19.8	110	12.7	0706812000	24-SDS-S20-N1/2T	
S 20	3/4 NPT	PN 400	16	48.1	32	20.1	175	14.9	0706802000	24-SDS-S20-N3/4T	•
S 20	1 NPT	PN 400	16	55	36	25	265	25.0	0706822000	24-SDS-S20-N1T	
S 25	3/4 NPT	PN 400	18	52.1	41	20.1	175	22.7	0706862000	24-SDS-S25-N3/4T	
S 25	1 NPT	PN 400	20	57	41	25	265	28.1	0706852000	24-SDS-S25-N1T	•
S 30	1 NPT	PN 400	22	59	46	25	265	32.2	0706912000	24-SDS-S30-N1T	
S 30	1 1/4 NPT	PN 400	25	59.6	46	25.6	315	39.3	0706902000	24-SDS-S30-N1/4T	•
S 38	1 1/2 NPT	PN 315	32	65	55	26	385	57.2	0706952000	24-SDS-S38-N11/2T	•

• Standard size

Straight male stud couplings

Male thread: metric fine thread, parallel

Sealing with seal edge

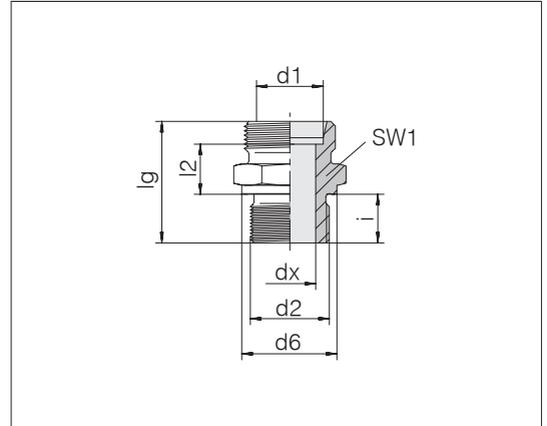

Series	Tube OD	d2	Pressure	d6	dx	lg	l2	SW1	i	Nm -10 %	kg/100 ca.	Order-No.	Designation
L	6	M 8 x 1	PN 100	12	3	23.5	8.5	12	8	14	1.1	0709012000	24-SDS-L6-M8B
L	6	M 10 x 1	PN 400	14	4	23.5	8.5	14	8	25	1.4	0709002000	24-SDS-L6-M10B
L	6	M 12 x 1.5	PN 400	17	4	27	10	17	10	35	2.2	0709022000	24-SDS-L6-M12B
L	6	M 14 x 1.5	PN 400	19	4	29	11	19	11	55	3.2	0709032000	24-SDS-L6-M14B
L	6	M 16 x 1.5	PN 400	21	4	30.5	11.5	22	12	80	3.6	0709042000	24-SDS-L6-M16B
L	8	M 10 x 1	PN 400	14	4	24.5	9.5	17	8	25	1.9	0709062000	24-SDS-L8-M10B
L	8	M 12 x 1.5	PN 400	17	6	29	10	17	12	35	2.2	0709052000	24-SDS-L8-M12B
L	8	M 14 x 1.5	PN 400	19	6	29	10	19	12	55	2.9	0709072000	24-SDS-L8-M14B
L	8	M 16 x 1.5	PN 400	21	6	30.5	11.5	22	12	80	4.2	0709082000	24-SDS-L8-M16B
L	8	M 18 x 1.5	PN 400	23	6	30.5	11.5	24	12	100	5.2	0709092000	24-SDS-L8-M18B
L	8	M 22 x 1.5	PN 400	27	6	31	10	27	14	170	6.9	1709132000	24-SDS-L8-M22B
L	10	M 10 x 1	PN 400	14	4	25.5	10.5	17	8	25	2.1	0709142000	24-SDS-L10-M10B
L	10	M 12 x 1.5	PN 400	17	6	30	11	17	12	35	2.5	0709112000	24-SDS-L10-M12B
L	10	M 14 x 1.5	PN 400	19	7	30	11	19	12	55	3.0	0709102000	24-SDS-L10-M14B
L	10	M 16 x 1.5	PN 400	21	7	31.5	12.5	22	12	80	4.2	0709122000	24-SDS-L10-M16B
L	10	M 18 x 1.5	PN 400	23	7	31.5	12.5	24	12	100	5.2	0709132000	24-SDS-L10-M18B
L	10	M 22 x 1.5	PN 400	27	8	35	14	27	14	170	8.1	1709142000	24-SDS-L10-M22B
L	12	M 12 x 1.5	PN 400	17	6	31.5	12.5	19	12	35	3.0	1709162000	24-SDS-L12-M12B
L	12	M 14 x 1.5	PN 400	19	7	31.5	12.5	19	12	55	3.4	0709162000	24-SDS-L12-M14B
L	12	M 16 x 1.5	PN 400	21	9	31.5	12.5	22	12	80	4.0	0709152000	24-SDS-L12-M16B
L	12	M 18 x 1.5	PN 400	23	9	31.5	12.5	24	12	100	4.5	0709172000	24-SDS-L12-M18B
L	12	M 22 x 1.5	PN 400	27	10	35	14	27	14	170	7.8	0709182000	24-SDS-L12-M22B
L	15	M 16 x 1.5	PN 400	21	9	32	13	24	12	80	4.8	0709212000	24-SDS-L15-M16B
L	15	M 18 x 1.5	PN 400	23	11	32.5	13.5	24	12	100	5.1	0709202000	24-SDS-L15-M18B
L	15	M 22 x 1.5	PN 400	27	12	36	15	27	14	170	7.8	0709222000	24-SDS-L15-M22B
L	15	M 26 x 1.5	PN 200	31	12	38	15	32	16	230	11.6	0785622000	24-SDS-L15-M26B
L	15	M 33 x 2	PN 200	39	12	41	16	41	18	400	16.5	0709242000	24-SDS-L15-M33B

● Standard size

Example for comp. :
GE06LM8x1X
ISO 8434-1-SDS-L6xM8x1-B-St

Continued on following page

Straight male stud couplings

Male thread: metric fine thread, parallel

Sealing with seal edge

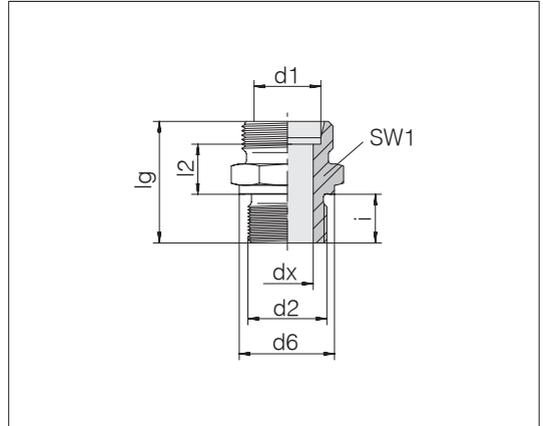

Series	d2	Pressure	d6	dx	lg	l2	SW1	i	Nm -10 %	kg/100 ca.	Order-No.	Designation
Tube OD d1												
L 18	M 16 x 1.5	PN 400	21	9	33	13.5	27	12	80	6.2	1709112000	24-SDS-L18-M16B
L 18	M 18 x 1.5	PN 400	23	11	33.5	14	27	12	100	6.6	0709262000	24-SDS-L18-M18B
L 18	M 22 x 1.5	PN 400	27	14	36	14.5	27	14	170	7.7	0709252000	24-SDS-L18-M22B •
L 18	M 26 x 1.5	PN 200	31	15	38	14.5	32	16	230	10.8	0709272000	24-SDS-L18-M26B
L 18	M 33 x 2	PN 200	39	14	41	15.5	41	18	400	20.9	0709282000	24-SDS-L18-M33B
L 22	M 18 x 1.5	PN 200	23	11	36	16.5	32	12	100	8.7	0709332000	24-SDS-L22-M18B
L 22	M 22 x 1.5	PN 200	27	14	38	16.5	32	14	170	9.3	0709312000	24-SDS-L22-M22B
L 22	M 26 x 1.5	PN 200	31	18	40	16.5	32	16	230	10.1	0709302000	24-SDS-L22-M26B •
L 22	M 33 x 2	PN 200	39	19	43	17.5	41	18	400	18.5	0709322000	24-SDS-L22-M33B
L 22	M 42 x 2	PN 200	49	18	51	23.5	50	20	700	43.0	1709122000	24-SDS-L22-M42B
L 28	M 26 x 1.5	PN 200	31	18	43	19.5	41	16	230	16.4	0709362000	24-SDS-L28-M26B
L 28	M 33 x 2	PN 200	39	23	43	17.5	41	18	400	16.7	0709352000	24-SDS-L28-M33B •
L 35	M 26 x 1.5	PN 200	31	18	44	17.5	46	16	230	20.5	0709412000	24-SDS-L35-M26B
L 35	M 42 x 2	PN 200	49	30	48	17.5	50	20	700	27.8	0709402000	24-SDS-L35-M42B •
L 42	M 42 x 2	PN 200	49	30	50	19	55	20	700	33.4	0709462000	24-SDS-L42-M42B
L 42	M 48 x 2	PN 200	55	36	52	19	55	22	900	35.4	0709452000	24-SDS-L42-M48B •

• Standard size

Continued on following page



Straight male stud couplings

Male thread: metric fine thread, parallel

Sealing with seal edge

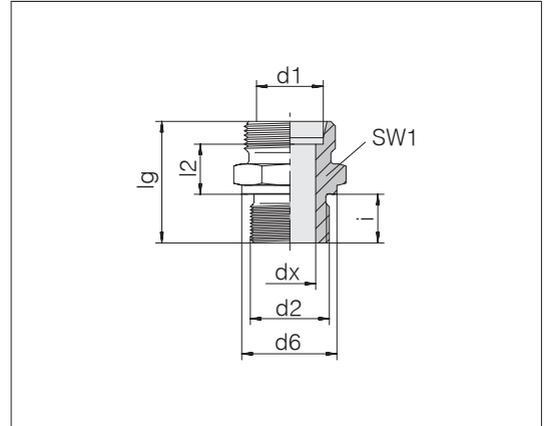

Series	Tube OD	d2	Pressure	d6	dx	lg	l2	SW1	i	Nm -10 %	kg/100 ca.	Order-No.	Designation	
S	6	M 12 x 1.5	PN 630	17	4	32	13	17	12	60	3.1	0709502000	24-SDS-S6-M12B	•
S	8	M 12 x 1.5	PN 630	17	4	34	15	17	12	60	3.6	0709562000	24-SDS-S8-M12B	
S	8	M 14 x 1.5	PN 630	19	5	34	15	19	12	90	4.3	0709552000	24-SDS-S8-M14B	•
S	8	M 18 x 1.5	PN 630	23	5	36.5	17.5	24	12	190	6.9	0709592000	24-SDS-S8-M18B	
S	8	M 22 x 1.5	PN 630	27	5	39	18	27	14	300	11.0	0709572000	24-SDS-S8-M22B	
S	10	M 14 x 1.5	PN 630	19	5	34	14.5	19	12	90	4.4	0709612000	24-SDS-S10-M14B	
S	10	M 16 x 1.5	PN 630	21	7	34.5	15	22	12	120	5.4	0709602000	24-SDS-S10-M16B	•
S	10	M 18 x 1.5	PN 630	23	7	36.5	17	24	12	190	7.1	0709622000	24-SDS-S10-M18B	
S	10	M 22 x 1.5	PN 630	27	7	39	17.5	27	14	300	11.0	0709632000	24-SDS-S10-M22B	
S	12	M 14 x 1.5	PN 630	19	5	36	16.5	22	12	90	5.9	1709102000	24-SDS-S12-M14B	
S	12	M 16 x 1.5	PN 630	21	8	36.5	17	22	12	120	6.0	0709662000	24-SDS-S12-M16B	
S	12	M 18 x 1.5	PN 630	23	8	36.5	17	24	12	190	7.1	0709652000	24-SDS-S12-M18B	•
S	12	M 22 x 1.5	PN 630	27	8	39	17.5	27	14	300	10.3	0709682000	24-SDS-S12-M22B	
S	12	M 27 x 2	PN 630	32	8	43	19.5	32	16	420	13.6	0785532000	24-SDS-S12-M27B	
S	14	M 18 x 1.5	PN 630	23	8	39	19	24	12	190	7.9	0709712000	24-SDS-S14-M18B	
S	14	M 20 x 1.5	PN 630	25	10	41	19	27	14	280	9.2	0709702000	24-SDS-S14-M20B	•
S	16	M 18 x 1.5	PN 630	23	8	38.5	18	24	12	190	7.8	0709792000	24-SDS-S16-M18B	
S	16	M 22 x 1.5	PN 630	27	12	41	18.5	27	14	300	9.7	0709752000	24-SDS-S16-M22B	•
S	16	M 27 x 2	PN 400	32	12	45	20.5	32	16	420	15.8	0709772000	24-SDS-S16-M27B	
S	20	M 18 x 1.5	PN 400	23	8	40.5	18	32	12	190	11.8	0709842000	24-SDS-S20-M18B	
S	20	M 22 x 1.5	PN 400	27	12	45	20.5	32	14	300	14.2	0709812000	24-SDS-S20-M22B	
S	20	M 27 x 2	PN 400	32	16	47	20.5	32	16	420	15.3	0709802000	24-SDS-S20-M27B	•
S	20	M 33 x 2	PN 400	39	16	51	22.5	41	18	600	25.0	0709822000	24-SDS-S20-M33B	
S	25	M 27 x 2	PN 400	32	16	51	23	41	16	420	24.1	0709862000	24-SDS-S25-M27B	
S	25	M 33 x 2	PN 400	39	20	53	23	41	18	600	26.6	0709852000	24-SDS-S25-M33B	•
S	30	M 33 x 2	PN 200	39	20	55	23.5	46	18	600	32.5	0709912000	24-SDS-S30-M33B	
S	30	M 42 x 2	PN 200	49	25	57	23.5	50	20	700	42.8	0709902000	24-SDS-S30-M42B	•
S	38	M 48 x 2	PN 200	55	32	64	26	55	22	900	57.3	0709952000	24-SDS-S38-M48B	•

• Standard size

Straight male stud couplings

Male thread: Whitworth pipe thread, parallel

Sealing with seal edge

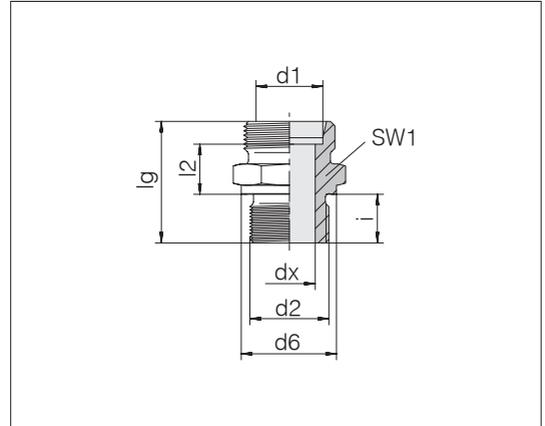

Series	d2	Pressure	d6	dx	lg	l2	SW1	i	Nm -10 %	kg/100 ca.	Order-No.	Designation
Tube OD d1												
L 6	G 1/8 A	PN 400	14	4	23.5	8.5	14	8	25	1.4	0710002000	24-SDS-L6-G1/8B •
L 6	G 1/4 A	PN 400	18	4	28	9	19	12	55	2.4	0710022000	24-SDS-L6-G1/4B
L 6	G 3/8 A	PN 400	22	4	30.5	11.5	22	12	95	4.0	0710032000	24-SDS-L6-G3/8B
L 6	G 1/2 A	PN 400	26	4	33	12	27	14	185	7.4	0710042000	24-SDS-L6-G1/2B
L 8	G 1/8 A	PN 400	14	4	24.5	9.5	17	8	25	1.8	0710062000	24-SDS-L8-G1/8B
L 8	G 1/4 A	PN 400	18	6	29	10	19	12	55	2.7	0710052000	24-SDS-L8-G1/4B •
L 8	G 3/8 A	PN 400	22	6	30.5	11.5	22	12	95	4.4	0710072000	24-SDS-L8-G3/8B
L 8	G 1/2 A	PN 400	26	6	33	12	27	14	185	7.4	0710082000	24-SDS-L8-G1/2B
L 10	G 1/8 A	PN 400	14	4	25.5	10.5	17	8	25	2.1	0710112000	24-SDS-L10-G1/8B
L 10	G 1/4 A	PN 400	18	6	30	11	19	12	55	3.0	0710102000	24-SDS-L10-G1/4B •
L 10	G 3/8 A	PN 400	22	7	31.5	12.5	22	12	95	4.5	0710122000	24-SDS-L10-G3/8B
L 10	G 1/2 A	PN 400	26	7	34	13	27	14	185	7.2	0710132000	24-SDS-L10-G1/2B
L 10	G 3/4 A	PN 400	32	8	37	14	32	16	230	10.4	1710152000	24-SDS-L10-G3/4B
L 12	G 1/4 A	PN 400	18	6	31	12	19	12	55	3.2	0710162000	24-SDS-L12-G1/4B
L 12	G 3/8 A	PN 400	22	9	31.5	12.5	22	12	95	4.2	0710152000	24-SDS-L12-G3/8B •
L 12	G 1/2 A	PN 400	26	9	34	13	27	14	185	7.1	0710172000	24-SDS-L12-G1/2B
L 12	G 3/4 A	PN 400	32	9	37	14	32	16	230	9.0	0710182000	24-SDS-L12-G3/4B
L 15	G 1/4 A	PN 400	18	6	32	13	24	12	55	4.6	0710232000	24-SDS-L15-G1/4B
L 15	G 3/8 A	PN 400	22	9	32.5	13.5	24	12	95	5.2	0710212000	24-SDS-L15-G3/8B
L 15	G 1/2 A	PN 400	26	11	35	14	27	14	185	7.1	0710202000	24-SDS-L15-G1/2B •
L 15	G 3/4 A	PN 400	32	12	38	15	32	16	250	11.7	0710222000	24-SDS-L15-G3/4B
L 18	G 3/8 A	PN 400	22	9	33.5	14	27	12	95	6.7	0710262000	24-SDS-L18-G3/8B
L 18	G 1/2 A	PN 400	26	14	36	14.5	27	14	185	7.0	0710252000	24-SDS-L18-G1/2B •
L 18	G 3/4 A	PN 400	32	15	38	14.5	32	16	250	11.0	0710272000	24-SDS-L18-G3/4B
L 18	G 1 A	PN 200	39	15	41	15.5	41	18	330	20.3	0710282000	24-SDS-L18-G1B
L 22	G 1/2 A	PN 200	26	14	38	16.5	32	14	185	8.8	0710312000	24-SDS-L22-G1/2B
L 22	G 3/4 A	PN 200	32	18	40	16.5	32	16	250	10.3	0710302000	24-SDS-L22-G3/4B •
L 22	G 1 A	PN 200	39	19	43	17.5	41	18	400	18.5	0710322000	24-SDS-L22-G1B

• Standard size

Example for comp. :
GE06LRX
ISO 8434-1-SDS-L6xG1/8A-B-St

Continued on following page



Straight male stud couplings

Male thread: Whitworth pipe thread, parallel

Sealing with seal edge

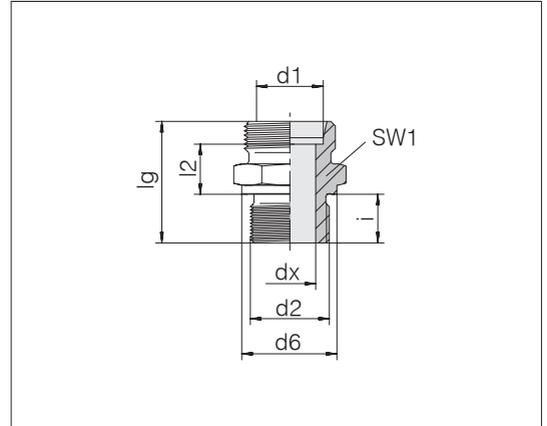

Series	Tube OD	d2	Pressure	d6	dx	lg	l2	SW1	i	Nm -10 %	kg/100 ca.	Order-No.	Designation
L	28	G 1/2 A	PN 200	26	14	39	17.5	41	14	185	14.3	1710362000	24-SDS-L28-G1/2B
L	28	G 3/4 A	PN 200	32	18	41	17.5	41	16	250	14.3	0710362000	24-SDS-L28-G3/4B
L	28	G 1 A	PN 200	39	23	43	17.5	41	18	400	16.9	0710352000	24-SDS-L28-G1B
L	28	G 1 1/4 A	PN 200	49	23	46	18.5	50	20	670	25.8	0710372000	24-SDS-L28-G11/4B
L	28	G 1 1/2 A	PN 200	55	24	50	20.5	55	22	800	34.6	1710242000	24-SDS-L28-G11/2B
L	35	G 3/4 A	PN 200	32	18	44	17.5	50	16	250	26.0	1710162000	24-SDS-L35-G3/4B
L	35	G 1 A	PN 200	39	23	46	17.5	50	18	400	24.1	0710412000	24-SDS-L35-G1B
L	35	G 1 1/4 A	PN 200	49	30	48	17.5	50	20	670	27.4	0710402000	24-SDS-L35-G11/4B
L	35	G 1 1/2 A	PN 200	55	30	52	19.5	55	22	800	47.2	0710422000	24-SDS-L35-G11/2B
L	42	G 1 A	PN 200	39	23	48	19	55	18	400	31.2	1710182000	24-SDS-L42-G1B
L	42	G 1 1/4 A	PN 200	49	30	50	19	55	20	670	33.1	0710462000	24-SDS-L42-G11/4B
L	42	G 1 1/2 A	PN 200	55	36	52	19	55	22	800	34.9	0710452000	24-SDS-L42-G11/2B
S	6	G 1/4 A	PN 500	18	4	32	13	19	12	95	3.5	0710502000	24-SDS-S6-G1/4B
S	6	G 3/8 A	PN 500	22	4	34.5	15.5	22	12	180	5.3	0710522000	24-SDS-S6-G3/8B
S	6	G 1/2 A	PN 500	26	4	35	14	27	14	160	6.7	0710532000	24-SDS-S6-G1/2B
S	8	G 1/4 A	PN 500	18	5	34	15	19	12	95	4.1	0710552000	24-SDS-S8-G1/4B
S	8	G 3/8 A	PN 500	22	5	34.5	15.5	22	12	180	5.5	0710572000	24-SDS-S8-G3/8B
S	8	G 1/2 A	PN 500	26	5	39	18	27	14	160	8.9	0710582000	24-SDS-S8-G1/2B
S	10	G 1/4 A	PN 500	18	5	34	14.5	19	12	95	4.2	0710612000	24-SDS-S10-G1/4B
S	10	G 3/8 A	PN 400	22	7	34.5	15	22	12	180	5.6	0710602000	24-SDS-S10-G3/8B
S	10	G 1/2 A	PN 400	26	7	35	13.5	27	14	160	7.8	0710622000	24-SDS-S10-G1/2B
S	12	G 1/4 A	PN 400	18	5	36	16.5	22	12	95	5.7	0710662000	24-SDS-S12-G1/4B
S	12	G 3/8 A	PN 400	22	8	36.5	17	22	12	180	6.2	0710652000	24-SDS-S12-G3/8B
S	12	G 1/2 A	PN 400	26	8	39	17.5	27	14	160	9.7	0710672000	24-SDS-S12-G1/2B
S	12	G 3/4 A	PN 400	32	8	43	19.5	32	16	350	14.9	0710682000	24-SDS-S12-G3/4B
S	14	G 3/8 A	PN 400	22	8	39	19	24	12	180	7.5	0710712000	24-SDS-S14-G3/8B
S	14	G 1/2 A	PN 400	26	10	41	19	27	14	160	9.8	0710702000	24-SDS-S14-G1/2B
S	14	G 3/4 A	PN 400	32	10	45	21	32	16	350	16.4	0710722000	24-SDS-S14-G3/4B

● Standard size

Continued on following page

Straight male stud couplings

Male thread: Whitworth pipe thread, parallel

Sealing with seal edge

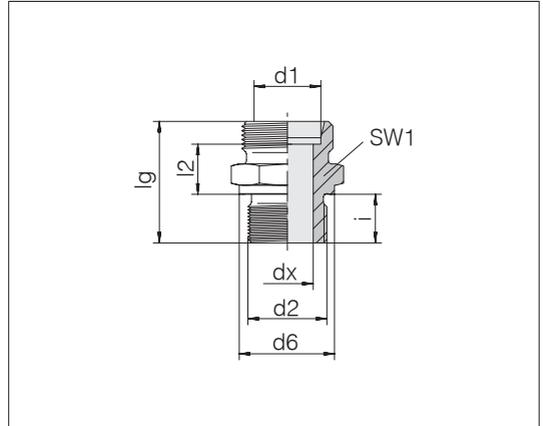

Series	d2	Pressure	d6	dx	lg	l2	SW1	i	Nm -10 %	kg/100 ca.	Order-No.	Designation
Tube OD d1												
S 16	G 3/8 A	PN 400	22	8	38.5	18	27	12	180	8.4	0710762000	24-SDS-S16-G3/8B
S 16	G 1/2 A	PN 400	26	12	41	18.5	27	14	160	9.1	0710752000	24-SDS-S16-G1/2B •
S 16	G 3/4 A	PN 400	32	12	45	20.5	32	16	350	15.5	0710772000	24-SDS-S16-G3/4B
S 16	G 1 A	PN 400	39	12	49	22.5	41	18	700	25.4	1710322000	24-SDS-S16-G1B
S 20	G 1/2 A	PN 200	26	12	45	20.5	32	14	160	13.3	0710812000	24-SDS-S20-G1/2B
S 20	G 3/4 A	PN 200	32	16	47	20.5	32	16	350	15.1	0710802000	24-SDS-S20-G3/4B •
S 20	G 1 A	PN 200	39	16	51	22.5	41	18	700	27.5	0710822000	24-SDS-S20-G1B
S 25	G 3/4 A	PN 200	32	16	51	23	41	16	350	24.1	0710862000	24-SDS-S25-G3/4B
S 25	G 1 A	PN 200	39	20	53	23	41	18	700	26.6	0710852000	24-SDS-S25-G1B •
S 25	G 1 1/4 A	PN 200	49	20	55	23	50	20	850	44.0	0710872000	24-SDS-S25-G11/4B
S 25	G 1 1/2 A	PN 200	55	20	60	26	55	22	1000	53.9	1710312000	24-SDS-S25-G11/2B
S 30	G 3/4 A	PN 200	32	16	53	23.5	46	16	350	29.9	0710932000	24-SDS-S30-G3/4B
S 30	G 1 A	PN 200	39	20	55	23.5	46	18	700	32.8	0710912000	24-SDS-S30-G1B
S 30	G 1 1/4 A	PN 200	49	25	57	23.5	50	20	850	41.7	0710902000	24-SDS-S30-G11/4B •
S 30	G 1 1/2 A	PN 200	55	25	62	26.5	55	22	1000	64.5	1710332000	24-SDS-S30-G11/2B
S 38	G 1 A	PN 200	39	20	60	26	55	18	700	49.2	0710982000	24-SDS-S38-G1B
S 38	G 1 1/4 A	PN 200	49	25	62	26	55	20	850	55.0	0710962000	24-SDS-S38-G11/4B
S 38	G 1 1/2 A	PN 200	55	32	64	26	55	22	1000	56.6	0710952000	24-SDS-S38-G11/2B •

• Standard size



Straight male stud couplings

Male thread: metric fine thread, parallel

Sealing with PEFLEX profile seal ring

Standard profile seal ring material is NBR

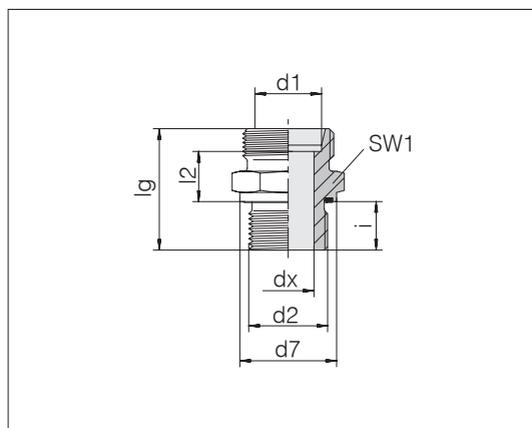

Series	Tube OD	d2	Pressure	d7	dx	lg	l2	SW1	i	Nm -10 %	kg/100 ca.	Order-No.	Designation
L	6	M 10 x 1	PN 500	13.9	4	23.5	8.5	14	8	15	1.4	0784392000	24-SDS-L6-M10E
L	6	M 12 x 1	PN 500	16.9	4	27	10	17	10	25	2.8	1785662000	24-SDS-L6-M12x1E
L	6	M 12 x 1.5	PN 500	16.9	4	29	10	17	12	25	2.3	1784612000	24-SDS-L6-M12E
L	6	M 14 x 1.5	PN 500	18.9	4	29	10	19	12	50	3.4	1785682000	24-SDS-L6-M14E
L	6	M 16 x 1.5	PN 400	21.9	4	30.5	11.5	22	12	70	3.4	1785442000	24-SDS-L6-M16E
L	6	M 18 x 1.5	PN 400	23.9	4	30.5	11.5	24	12	90	3.6	1785462000	24-SDS-L6-M18E
L	8	M 10 x 1	PN 500	13.9	4	24.5	9.5	14	8	15	1.6	1784442000	24-SDS-L8-M10E
L	8	M 12 x 1.5	PN 500	16.9	6	29	10	17	12	25	2.1	0784402000	24-SDS-L8-M12E
L	8	M 14 x 1.5	PN 500	18.9	6	29	10	19	12	50	2.8	0784112000	24-SDS-L8-M14E
L	8	M 16 x 1.5	PN 400	21.9	6	30.5	11.5	22	12	70	4.1	1784862000	24-SDS-L8-M16E
L	8	M 18 x 1.5	PN 400	23.9	6	30.5	11.5	24	12	90	5.0	1798492000	24-SDS-L8-M18E
L	8	M 22 x 1.5	PN 400	26.9	6	34	13	27	14	130	5.5	1785552000	24-SDS-L8-M22E
L	10	M 10 x 1	PN 500	13.9	4	25.5	11.5	17	8	15	2.3	1785982000	24-SDS-L10-M10E
L	10	M 12 x 1	PN 500	16.9	6	28	11	17	10	25	2.6	1795042000	24-SDS-L10-M12x1E
L	10	M 12 x 1.5	PN 500	16.9	6	30	11	17	12	25	2.4	1784622000	24-SDS-L10-M12E
L	10	M 14 x 1.5	PN 500	18.9	7	30	11	19	12	50	2.9	0784412000	24-SDS-L10-M14E
L	10	M 16 x 1.5	PN 400	21.9	7	31.5	12.5	22	12	70	4.2	1784602000	24-SDS-L10-M16E
L	10	M 18 x 1.5	PN 400	23.9	8	31.5	12.5	24	12	90	4.9	0784042000	24-SDS-L10-M18E
L	10	M 22 x 1.5	PN 400	26.9	8	35	14	27	14	130	8.0	1784872000	24-SDS-L10-M22E
L	12	M 10 x 1	PN 400	13.9	4	27	12	19	8	15	2.7	1784892000	24-SDS-L12-M10E
L	12	M 12 x 1.5	PN 400	16.9	6	31.5	12.5	19	12	25	3.0	1784852000	24-SDS-L12-M12E
L	12	M 14 x 1.5	PN 400	18.9	7	30	11	19	12	50	2.9	1784402000	24-SDS-L12-M14E
L	12	M 16 x 1.5	PN 400	21.9	9	31.5	12.5	22	12	70	3.9	0784422000	24-SDS-L12-M16E
L	12	M 18 x 1.5	PN 400	23.9	9	31.5	12.5	24	12	90	4.4	1784482000	24-SDS-L12-M18E
L	12	M 22 x 1.5	PN 400	26.9	9	35	14	27	14	130	6.4	1784492000	24-SDS-L12-M22E
L	12	M 26 x 1.5	PN 250	31.9	10	37	14	32	16	180	10.0	1785532000	24-SDS-L12-M26E
L	15	M 12 x 1.5	PN 400	16.9	6	32	13	24	12	25	4.8	1796032000	24-SDS-L15-M12E
L	15	M 16 x 1.5	PN 400	21.9	9	32	13	24	12	70	4.8	1784562000	24-SDS-L15-M16E
L	15	M 18 x 1.5	PN 400	23.9	11	32.5	13.5	24	12	90	5.1	0784432000	24-SDS-L15-M18E
L	15	M 22 x 1.5	PN 400	26.9	12	36	15	27	14	130	7.1	1784502000	24-SDS-L15-M22E
L	15	M 26 x 1.5	PN 250	31.9	12	38	15	32	16	180	11.3	1784542000	24-SDS-L15-M26E

● Standard size

Example for comp.:
GE06LMEDOMD
ISO 8434-1-SDS-L6xM10x1-E-St

Continued on following page

Straight male stud couplings

Male thread: metric fine thread, parallel

Sealing with PEFLEX profile seal ring

Standard profile seal ring material is NBR

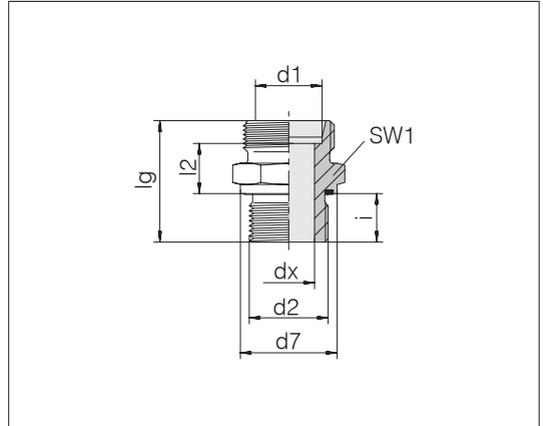

Series	d2	Pressure	d7	dx	lg	l2	SW1	i	Nm -10 %	kg/100 ca.	Order-No.	Designation
Tube OD d1												
L 18	M 18 x 1.5	PN 400	23.9	11	33.5	14	27	12	90	6.5	1784452000	24-SDS-L18-M18E
L 18	M 22 x 1.5	PN 400	26.9	14	36	14.5	27	14	130	7.4	0784442000	24-SDS-L18-M22E •
L 18	M 26 x 1.5	PN 250	31.9	15	38	14.5	32	16	180	9.4	1784472000	24-SDS-L18-M26E
L 18	M 27 x 2	PN 250	31.9	15	43	19.5	32	16	180	14.8	1796872000	24-SDS-L18-M27E
L 18	M 33 x 2	PN 250	39.9	15	41	15.5	41	18	230	16.0	1798222000	24-SDS-L18-M33E
L 22	M 18 x 1.5	PN 250	23.9	11	35.5	16	32	12	90	9.0	1785252000	24-SDS-L22-M18E
L 22	M 22 x 1.5	PN 250	26.9	14	38	16.5	32	14	130	9.0	1784462000	24-SDS-L22-M22E
L 22	M 26 x 1.5	PN 250	31.9	18	40	16.5	32	16	180	10.1	0784452000	24-SDS-L22-M26E •
L 22	M 27 x 2	PN 250	31.9	18	40	16.5	32	16	180	10.8	1798422000	24-SDS-L22-M27E
L 22	M 33 x 2	PN 250	39.9	19	43	17.5	41	18	230	18.6	1784732000	24-SDS-L22-M33E
L 28	M 18 x 1.5	PN 250	23.9	11	36.5	17	41	12	90	12.9	1785452000	24-SDS-L28-M18E
L 28	M 22 x 1.5	PN 250	26.9	14	39	17.5	41	14	130	13.7	1784802000	24-SDS-L28-M22E
L 28	M 26 x 1.5	PN 250	31.9	18	43	19.5	41	16	180	16.2	1784592000	24-SDS-L28-M26E
L 28	M 33 x 2	PN 250	39.9	23	43	17.5	41	18	230	16.4	0784462000	24-SDS-L28-M33E •
L 28	M 42 x 2	PN 250	49.9	23	47	19.5	50	20	330	32.2	1784512000	24-SDS-L28-M42E
L 35	M 33 x 2	PN 250	39.9	23	46	17.5	46	18	230	21.7	1784392000	24-SDS-L35-M33E
L 35	M 42 x 2	PN 250	49.9	30	48	17.5	50	20	330	27.3	0784472000	24-SDS-L35-M42E •
L 42	M 42 x 2	PN 250	49.9	30	50	19	55	20	330	33.6	1784782000	24-SDS-L42-M42E
L 42	M 48 x 2	PN 250	54.9	36	52	19	55	22	500	34.6	0784482000	24-SDS-L42-M48E •

• Standard size

Continued on following page



Straight male stud couplings

Male thread: metric fine thread, parallel

Sealing with PEFLEX profile seal ring

Standard profile seal ring material is NBR

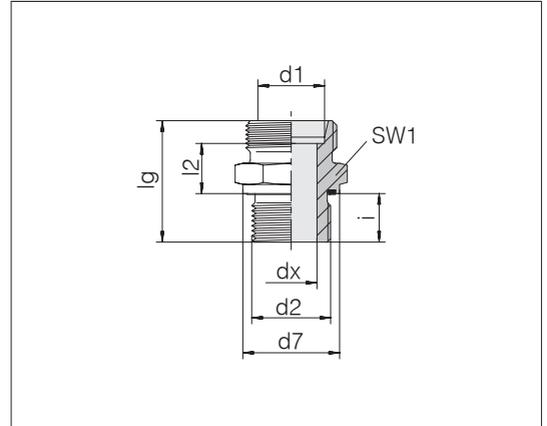

Series	Tube OD	d2	Pressure	d7	dx	lg	l2	SW1	i	Nm -10 %	kg/100 ca.	Order-No.	Designation	
S	6	M 12 x 1.5	PN 800	16.9	4	32	13	17	12	50	2.9	0784492000	24-SDS-S6-M12E	•
S	8	M 12 x 1.5	PN 800	16.9	4	34	15	17	12	50	3.8	1785602000	24-SDS-S8-M12E	
S	8	M 14 x 1.5	PN 800	18.9	5	34	15	19	12	60	4.1	0784502000	24-SDS-S8-M14E	•
S	8	M 18 x 1.5	PN 630	23.9	5	36.5	17.5	24	12	90	6.5	1785432000	24-SDS-S8-M18E	
S	8	M 22 x 1.5	PN 630	26.9	5	41	20	27	14	130	10.4	1785342000	24-SDS-S8-M22E	
S	10	M 12 x 1.5	PN 800	16.9	4	34.5	15	19	12	50	4.5	1796512000	24-SDS-S10-M12E	
S	10	M 16 x 1.5	PN 800	21.9	7	34.5	15	22	12	80	5.3	0784512000	24-SDS-S10-M16E	•
S	10	M 18 x 1.5	PN 630	23.9	7	36.5	17	24	12	90	7.6	1785672000	24-SDS-S10-M18E	
S	12	M 12 x 1.5	PN 800	16.9	4	36	16.5	22	12	50	5.2	1785592000	24-SDS-S12-M12E	
S	12	M 14 x 1.5	PN 800	18.9	5	36	16.5	22	12	60	6.2	1796332000	24-SDS-S12-M14E	
S	12	M 16 x 1.5	PN 800	21.9	7	36	16.5	22	12	80	6.9	1785172000	24-SDS-S12-M16E	
S	12	M 18 x 1.5	PN 630	23.9	8	36.5	17	24	12	90	7.1	0784522000	24-SDS-S12-M18E	•
S	12	M 20 x 1.5	PN 630	25.9	8	39	17.5	27	14	130	10.0	1795192000	24-SDS-S12-M20E	
S	12	M 22 x 1.5	PN 630	26.9	8	39	17.5	27	14	130	10.2	1784832000	24-SDS-S12-M22E	
S	14	M 18 x 1.5	PN 630	23.9	8	39	19	24	12	90	7.7	1784672000	24-SDS-S14-M18E	
S	14	M 20 x 1.5	PN 630	25.9	10	41	19	27	14	130	9.4	0784532000	24-SDS-S14-M20E	•
S	16	M 16 x 1.5	PN 800	21.9	7	39	18.5	27	12	50	8.4	1785372000	24-SDS-S16-M16E	
S	16	M 18 x 1.5	PN 630	23.9	10	38.5	18	27	12	90	8.1	0784062000	24-SDS-S16-M18E	
S	16	M 22 x 1.5	PN 630	26.9	12	41	18.5	27	14	130	9.6	0784542000	24-SDS-S16-M22E	•
S	16	M 27 x 2	PN 420	31.9	12	45	20.5	32	16	200	15.7	1784682000	24-SDS-S16-M27E	
S	20	M 22 x 1.5	PN 420	26.9	12	45	20.5	32	14	130	13.9	0784022000	24-SDS-S20-M22E	
S	20	M 26 x 1.5	PN 420	31.9	16	47	20.5	32	16	190	16.3	1785782000	24-SDS-S20-M26E	
S	20	M 27 x 2	PN 420	31.9	16	47	20.5	32	16	200	15.1	0784552000	24-SDS-S20-M27E	•
S	25	M 26 x 1.5	PN 800	31.9	16	51	23	41	16	50	25.0	1798432000	24-SDS-S25-M26E	
S	25	M 27 x 2	PN 420	31.9	16	51	23	41	16	200	23.7	1784792000	24-SDS-S25-M27E	
S	25	M 33 x 2	PN 420	39.9	20	53	23	41	18	250	26.5	0784562000	24-SDS-S25-M33E	•
S	30	M 33 x 2	PN 420	39.9	25	55	23.5	46	18	250	34.9	1796342000	24-SDS-S30-M33E	
S	30	M 42 x 2	PN 420	49.9	25	57	23.5	50	20	500	41.7	0784572000	24-SDS-S30-M42E	•
S	38	M 48 x 2	PN 420	54.9	32	64	26	55	22	600	56.4	0784582000	24-SDS-S38-M48E	•

• Standard size

Straight male stud couplings

Male thread: Whitworth pipe thread, parallel

Sealing with PEFLEX profile seal ring

Standard profile seal ring material is NBR

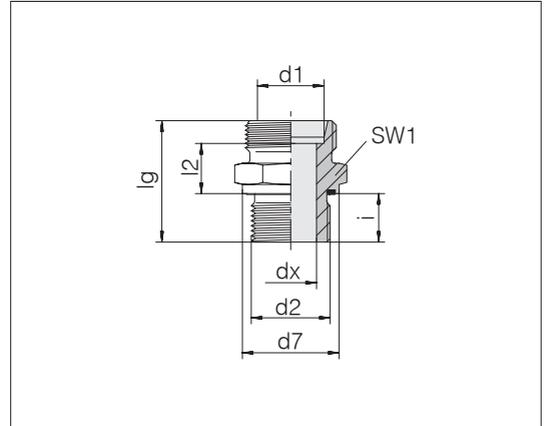

Series	d2	Pressure	d7	dx	lg	l2	SW1	i	Nm -10 %	kg/100 ca.	Order-No.	Designation
Tube OD d1												
L 6	G 1/8 A	PN 500	13.9	4	23.5	8.5	14	8	20	1.3	0784192000	24-SDS-L6-G1/8E •
L 6	G 1/4 A	PN 500	18.9	4	29	10	19	12	50	2.7	1784082000	24-SDS-L6-G1/4E
L 6	G 3/8 A	PN 400	21.9	4	30.5	11.5	22	12	80	3.8	1784942000	24-SDS-L6-G3/8E
L 8	G 1/8 A	PN 500	13.9	4	24.5	9.5	14	8	20	1.5	1784222000	24-SDS-L8-G1/8E
L 8	G 1/4 A	PN 500	18.9	6	29	10	19	12	50	2.7	0784202000	24-SDS-L8-G1/4E •
L 8	G 3/8 A	PN 400	21.9	6	30.5	11.5	22	12	80	4.4	1784232000	24-SDS-L8-G3/8E
L 8	G 1/2 A	PN 400	26.9	6	33	12	27	14	100	7.2	1784912000	24-SDS-L8-G1/2E
L 8	G 3/4 A	PN 250	31.9	6	36	13	32	16	180	10.0	1785762000	24-SDS-L8-G3/4E
L 10	G 1/8 A	PN 500	13.9	4	25.5	10.5	17	8	20	2.0	1784932000	24-SDS-L10-G1/8E
L 10	G 1/4 A	PN 500	18.9	6	30	11	19	12	50	2.9	0784212000	24-SDS-L10-G1/4E •
L 10	G 3/8 A	PN 400	21.9	8	31.5	12.5	22	12	80	4.2	1784172000	24-SDS-L10-G3/8E
L 10	G 1/2 A	PN 400	26.9	8	34	13	27	14	100	6.3	1784182000	24-SDS-L10-G1/2E
L 12	G 1/4 A	PN 400	18.9	6	31.5	12.5	19	12	50	3.2	0784102000	24-SDS-L12-G1/4E
L 12	G 3/8 A	PN 400	21.9	9	31.5	12.5	22	12	80	4.2	0784222000	24-SDS-L12-G3/8E •
L 12	G 1/2 A	PN 400	26.9	10	34	13	27	14	100	6.7	0784122000	24-SDS-L12-G1/2E
L 12	G 3/4 A	PN 250	31.9	10	37	14	32	16	180	11.7	1784212000	24-SDS-L12-G3/4E
L 15	G 1/4 A	PN 400	18.9	6	32	13	24	12	50	3.9	1785642000	24-SDS-L15-G1/4E
L 15	G 3/8 A	PN 400	21.9	9	32.5	13.5	24	12	80	5.1	1784072000	24-SDS-L15-G3/8E
L 15	G 1/2 A	PN 400	26.9	11	35	14	27	14	100	7.1	0784232000	24-SDS-L15-G1/2E •
L 15	G 3/4 A	PN 250	31.9	12	38	15	32	16	180	11.7	1784192000	24-SDS-L15-G3/4E
L 15	G 1 A	PN 250	39.9	11	41	16	41	18	230	22.8	1796972000	24-SDS-L15-G1E
L 18	G 3/8 A	PN 400	21.9	9	33.5	14	27	12	80	6.6	1784922000	24-SDS-L18-G3/8E
L 18	G 1/2 A	PN 400	26.9	14	36	14.5	27	14	100	7.0	0784242000	24-SDS-L18-G1/2E •
L 18	G 3/4 A	PN 250	31.9	15	38	14.5	32	16	180	10.9	1784282000	24-SDS-L18-G3/4E
L 18	G 1 A	PN 250	39.9	15	41	15.5	41	18	230	16.7	1785972000	24-SDS-L18-G1E
L 18	G 1 1/4 A	PN 250	49.9	15	44	16.5	50	20	330	37.9	1796842000	24-SDS-L18-G11/4E
L 22	G 1/2 A	PN 250	26.9	14	38	16.5	32	14	100	8.7	1784162000	24-SDS-L22-G1/2E
L 22	G 3/4 A	PN 250	31.9	18	40	16.5	32	16	180	10.2	0784252000	24-SDS-L22-G3/4E •
L 22	G 1 A	PN 250	39.9	19	43	17.5	41	18	230	18.4	1784712000	24-SDS-L22-G1E
L 22	G 1 1/4 A	PN 250	49.9	19	46	18.5	50	20	330	37.5	1785132000	24-SDS-L22-G11/4E

• Standard size

Example for comp. :
GE06LREDOMD
ISO 8434-1-SDS-L6xG1/8A-E-St

Continued on following page



Straight male stud couplings

Male thread: Whitworth pipe thread, parallel

Sealing with PEFLEX profile seal ring

Standard profile seal ring material is NBR

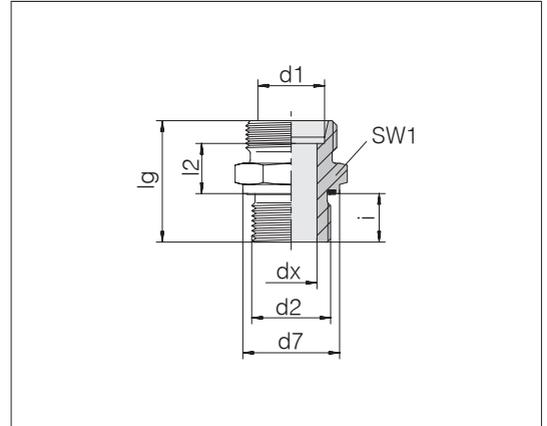

Series	Tube OD	d2	Pressure	d7	dx	lg	l2	SW1	i	Nm -10 %	kg/100 ca.	Order-No.	Designation
L	28	G 3/4 A	PN 250	31.9	18	41	17.5	41	16	180	14.6	1784122000	24-SDS-L28-G3/4E
L	28	G 1 A	PN 250	39.9	23	43	17.5	41	18	230	16.5	0784262000	24-SDS-L28-G1E
L	28	G 1 1/4 A	PN 250	49.9	23	46	18.5	50	20	330	25.2	1784902000	24-SDS-L28-G11/4E
L	35	G 1 A	PN 250	39.9	23	46	17.5	50	18	230	23.8	1784362000	24-SDS-L35-G1E
L	35	G 1 1/4 A	PN 250	49.9	30	48	17.5	50	20	330	27.1	0784272000	24-SDS-L35-G11/4E
L	35	G 1 1/2 A	PN 250	54.9	30	52	19.5	55	22	500	37.4	1785612000	24-SDS-L35-G11/2E
L	42	G 1 1/4 A	PN 250	49.9	30	50	19	55	20	330	33.6	1785652000	24-SDS-L42-G11/4E
L	42	G 1 1/2 A	PN 250	54.9	36	52	19	55	22	500	34.3	0784282000	24-SDS-L42-G11/2E
S	6	G 1/4 A	PN 800	18.9	4	32	13	19	12	60	3.5	0784292000	24-SDS-S6-G1/4E
S	6	G 3/8 A	PN 800	21.9	4	34.5	15.5	22	12	90	6.0	1784052000	24-SDS-S6-G3/8E
S	6	G 1/2 A	PN 630	26.9	4	39	18	27	14	150	8.6	1784252000	24-SDS-S6-G1/2E
S	8	G 1/4 A	PN 800	18.9	5	34	15	19	12	60	4.1	0784302000	24-SDS-S8-G1/4E
S	8	G 3/8 A	PN 800	21.9	5	34.5	15.5	22	12	90	5.7	1784132000	24-SDS-S8-G3/8E
S	8	G 1/2 A	PN 630	26.9	5	39	18	27	14	150	9.5	1785942000	24-SDS-S8-G1/2E
S	10	G 1/4 A	PN 800	18.9	5	34	14.5	19	12	60	4.2	0784152000	24-SDS-S10-G1/4E
S	10	G 3/8 A	PN 800	21.9	7	34.5	15	22	12	90	5.5	0784312000	24-SDS-S10-G3/8E
S	10	G 1/2 A	PN 630	26.9	7	39	17.5	27	14	150	8.9	1784242000	24-SDS-S10-G1/2E
S	12	G 1/4 A	PN 630	18.9	5	36	16.5	22	12	60	5.6	1784142000	24-SDS-S12-G1/4E
S	12	G 3/8 A	PN 630	21.9	8	36.5	17	22	12	90	6.2	0784322000	24-SDS-S12-G3/8E
S	12	G 1/2 A	PN 630	26.9	8	39	17.5	27	14	150	9.1	0784172000	24-SDS-S12-G1/2E
S	12	G 3/4 A	PN 420	31.9	8	43	19.5	32	16	200	13.4	1784152000	24-SDS-S12-G3/4E
S	14	G 3/8 A	PN 800	21.9	8	39	19	24	12	90	8.3	1785922000	24-SDS-S14-G3/8E
S	14	G 1/2 A	PN 630	26.9	10	41	19	27	14	150	9.6	0784332000	24-SDS-S14-G1/2E
S	16	G 1/4 A	PN 630	18.9	5	38	17.5	27	12	60	8.4	1785302000	24-SDS-S16-G1/4E
S	16	G 3/8 A	PN 630	21.9	8	38.5	18	27	12	90	8.1	1784092000	24-SDS-S16-G3/8E
S	16	G 1/2 A	PN 630	26.9	12	41	18.5	27	14	150	9.2	0784342000	24-SDS-S16-G1/2E
S	16	G 3/4 A	PN 420	31.9	12	45	20.5	32	16	200	13.8	1784262000	24-SDS-S16-G3/4E
S	16	G 1 A	PN 420	39.9	12	49	22.5	41	18	250	23.7	1784722000	24-SDS-S16-G1E

● Standard size

Continued on following page

Straight male stud couplings

Male thread: Whitworth pipe thread, parallel

Sealing with PEFLEX profile seal ring

Standard profile seal ring material is NBR

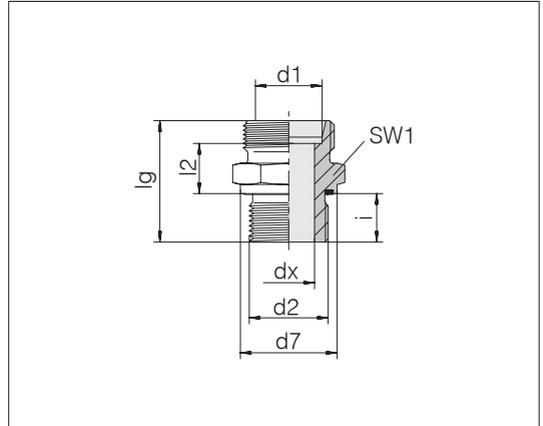

Series	d2	Pressure	d7	dx	lg	l2	SW1	i	Nm -10 %	kg/100 ca.	Order-No.	Designation
Tube OD d1												
S 20	G 1/2 A	PN 420	26.9	12	45	20.5	32	14	150	13.5	1784062000	24-SDS-S20-G1/2E
S 20	G 3/4 A	PN 420	31.9	16	47	20.5	32	16	200	14.9	0784352000	24-SDS-S20-G3/4E
S 20	G 1 A	PN 420	39.9	16	51	22.5	41	18	250	25.0	1784382000	24-SDS-S20-G1E
S 25	G 1/2 A	PN 420	26.9	12	49	23	41	14	150	23.9	1785632000	24-SDS-S25-G1/2E
S 25	G 3/4 A	PN 420	31.9	16	51	23	41	16	200	23.7	0784032000	24-SDS-S25-G3/4E
S 25	G 1 A	PN 420	39.9	20	53	23	41	18	250	26.3	0784362000	24-SDS-S25-G1E
S 25	G 1 1/4 A	PN 420	49.9	20	55	23	50	20	500	46.7	1785772000	24-SDS-S25-G11/4E
S 30	G 3/4 A	PN 420	31.9	16	53	23.5	46	16	200	31.7	1785712000	24-SDS-S30-G3/4E
S 30	G 1 A	PN 420	39.9	20	55	23.5	46	18	250	33.0	1784112000	24-SDS-S30-G1E
S 30	G 1 1/4 A	PN 420	49.9	25	57	23.5	50	20	500	41.9	0784372000	24-SDS-S30-G11/4E
S 30	G 1 1/2 A	PN 420	54.9	25	62	26.5	55	22	600	64.0	1785962000	24-SDS-S30-G11/2E
S 38	G 3/4 A	PN 420	31.9	16	58	26	55	16	200	50.1	1785902000	24-SDS-S38-G3/4E
S 38	G 1 A	PN 420	39.9	20	60	26	55	18	250	44.9	1785702000	24-SDS-S38-G1E
S 38	G 1 1/4 A	PN 420	49.9	25	62	26	55	20	500	55.5	1785212000	24-SDS-S38-G11/4E
S 38	G 1 1/2 A	PN 420	54.9	32	64	26	55	22	600	55.9	0784382000	24-SDS-S38-G11/2E

● Standard size

Straight male stud couplings

Male thread: UN/UNF

Sealing with O-ring

Standard O-ring material is NBR

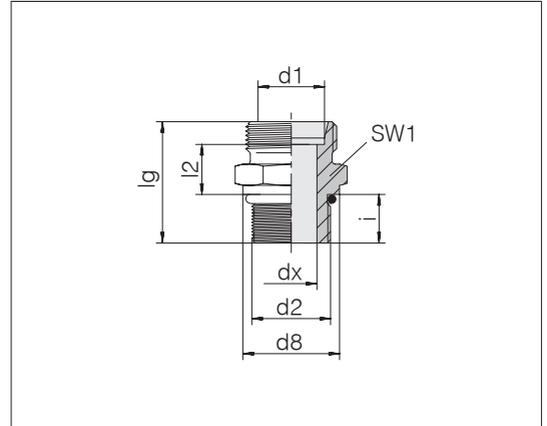

Series	d2	Pressure	d8	dx	lg	l2	SW1	i	Nm -10 %	kg/100 ca.	Order-No.	Designation
L 6	7/16-20 UNF-2A	PN 500	15.8	4	25.2	9	17	9.2	25	1.9	0782402000	24-SDS-L6-U7/16-20F
L 6	9/16-18 UNF-2A	PN 500	17.7	4	27	15	32	15	30	2.5	1782572000	24-SDS-L6-U9/16-18F
L 8	7/16-20 UNF-2A	PN 500	15.8	5	26.2	10	17	9.2	25	2.1	0782412000	24-SDS-L8-U7/16-20F
L 8	1/2-20 UNF-2A	PN 500	16.2	6	26.2	10	17	9.2	28	2.2	0782422000	24-SDS-L8-U1/2-20F
L 8	9/16-18 UNF-2A	PN 500	17.7	6	27	10	19	10	30	2.8	0782432000	24-SDS-L8-U9/16-18F
L 8	3/4-16 UNF-2A	PN 400	23	6	30	11.8	24	11.2	55	4.3	1782502000	24-SDS-L8-U3/4-16F
L 10	7/16-20 UNF-2A	PN 500	15.8	5	28.2	12	17	9.2	25	2.4	0782962000	24-SDS-L10-U7/16-20F
L 10	9/16-18 UNF-2A	PN 500	17.7	7	28	11	19	10	30	2.8	0782442000	24-SDS-L10-U9/16-18F
L 10	3/4-16 UNF-2A	PN 400	23	8	31	12.8	24	11.2	55	4.4	1782512000	24-SDS-L10-U3/4-16F
L 10	7/8-14 UNF-2A	PN 400	27	7	32.5	12.8	27	12.7	60	7.6	0782452000	24-SDS-L10-U7/8-14F
L 12	7/16-20 UNF-2A	PN 400	17.7	5	28.5	12.3	19	9.2	25	2.6	0782492000	24-SDS-L12-U7/16-20F
L 12	1/2-20 UNF-2A	PN 400	16.8	6	28.5	12.3	19	9.2	28	3.0	1782562000	24-SDS-L12-U1/2-20F
L 12	9/16-18 UNF-2A	PN 400	17.7	7	29.5	12.5	19	10	30	3.2	0782462000	24-SDS-L12-U9/16-18F
L 12	3/4-16 UNF-2A	PN 400	23	9	30.7	12.5	24	11.2	55	4.5	0782482000	24-SDS-L12-U3/4-16F
L 12	7/8-14 UNF-2A	PN 400	27	10	32.7	13	27	12.7	60	7.0	0782502000	24-SDS-L12-U7/8-14F
L 15	9/16-18 UNF-2A	PN 400	17.7	7	31	14	24	10	30	4.8	0782512000	24-SDS-L15-U9/16-18F
L 15	3/4-16 UNF-2A	PN 400	23	11	32.2	14	24	11.2	55	5.4	0782522000	24-SDS-L15-U3/4-16F
L 15	7/8-14 UNF-2A	PN 400	27	11	33.7	14	27	12.7	60	7.5	0782532000	24-SDS-L15-U7/8-14F
L 15	1 1/16-12 UN-2A	PN 400	32	12	37	15	32	15	110	11.7	1782482000	24-SDS-L15-U11/16-12F
L 15	1 5/16-12 UN-2A	PN 250	38.1	12	37	15	41	15	165	18.7	1782452000	24-SDS-L15-U15/16-12F
L 18	3/4-16 UNF-2A	PN 400	23	12	33.2	14.5	27	11.2	55	6.6	0782542000	24-SDS-L18-U3/4-16F
L 18	7/8-14 UNF-2A	PN 400	27	14	34.7	14.5	27	12.7	60	7.4	0782552000	24-SDS-L18-U7/8-14F
L 18	1 1/16-12 UN-2A	PN 400	32	15	37	14.5	32	15	110	9.6	0782902000	24-SDS-L18-U11/16-12F
L 18	1 5/16-12 UN-2A	PN 250	38.1	15	37	14.5	41	15	165	18.3	1782472000	24-SDS-L18-U15/16-12F
L 22	7/8-14 UNF-2A	PN 250	27	12	36.7	16.5	32	12.7	60	9.8	0782562000	24-SDS-L22-U7/8-14F
L 22	1 1/16-12 UN-2A	PN 250	32	18	39	16.5	32	15	110	10.2	0782572000	24-SDS-L22-U11/16-12F
L 22	1 5/16-12 UN-2A	PN 250	38.1	18	39	16.5	41	15	165	17.3	0782582000	24-SDS-L22-U15/16-12F
L 22	1 5/8-12 UN-2A	PN 250	48	19	40	17.5	50	15	200	28.7	1782462000	24-SDS-L22-U15/8-12F

Straight male stud couplings

Male thread: UN/UNF

Sealing with O-ring

Standard O-ring material is NBR

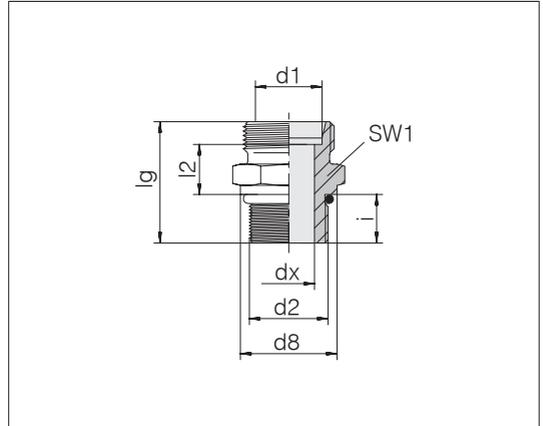

Series	d2	Pressure	d8	dx	lg	l2	SW1	i	Nm -10 %	kg/100 ca.	Order-No.	Designation
L 28	7/8-14 UNF-2A	PN 250	27	12	37.7	17.5	41	12.7	60	13.7	0782872000	24-SDS-L28-U7/8-14F
L 28	1 1/16-12 UN-2A	PN 250	32	18	40	17.5	41	15	110	14.3	0782592000	24-SDS-L28-U11/16-12F
L 28	1 5/16-12 UN-2A	PN 250	38.1	23	40	17.5	41	15	165	16.2	0782602000	24-SDS-L28-U15/16-12F
L 28	1 5/8-12 UN-2A	PN 250	48	24	40	17.5	50	15	220	26.4	0782922000	24-SDS-L28-U15/8-12F
L 35	1 3/16-12 UN-2A	PN 250	35	20	43	17.5	46	15	140	20.3	0782912000	24-SDS-L35-U13/16-12F
L 35	1 5/16-12 UN-2A	PN 250	39	23	43	17.5	46	15	165	21.1	0782612000	24-SDS-L35-U15/16-12F
L 35	1 5/8-12 UN-2A	PN 250	48	30	43	17.5	50	15	220	24.9	0782842000	24-SDS-L35-U15/8-12F
L 35	1 7/8-12 UN-2A	PN 250	54	30	45	19.5	55	15	260	31.2	0782972000	24-SDS-L35-U17/8-12F
L 42	1 5/8-12 UN-2A	PN 250	48	30	45	19	55	15	220	30.8	0782932000	24-SDS-L42-U15/8-12F
L 42	1 7/8-12 UN-2A	PN 250	54	36	45	19	55	15	260	31.6	0782622000	24-SDS-L42-U17/8-12F
S 6	7/16-20 UNF-2A	PN 800	15.8	4	29.2	13	17	9.2	30	2.7	0782642000	24-SDS-S6-U7/16-20F
S 8	7/16-20 UNF-2A	PN 800	15.8	4	31.2	15	17	9.2	30	3.2	0782882000	24-SDS-S8-U7/16-20F
S 8	1/2-20 UNF-2A	PN 800	16.2	5	31.2	15	17	9.2	45	3.4	0782652000	24-SDS-S8-U1/2-20F
S 8	9/16-18 UNF-2A	PN 800	17.7	5	32	15	19	10	75	4.5	0782632000	24-SDS-S8-U9/16-18F
S 10	9/16-18 UNF-2A	PN 800	17.7	7	32.5	15	19	10	75	4.1	0782662000	24-SDS-S10-U9/16-18F
S 10	3/4-16 UNF-2A	PN 800	23	7	33.7	15	24	11.2	100	6.6	0782672000	24-SDS-S10-U3/4-16F
S 12	9/16-18 UNF-2A	PN 800	17.7	7	34.5	17.5	22	10	75	5.5	1782422000	24-SDS-S12-U9/16-18F
S 12	3/4-16 UNF-2A	PN 630	23	8	36.2	17.5	24	11.2	100	7.4	0782692000	24-SDS-S12-U3/4-16F
S 12	7/8-14 UNF-2A	PN 630	27	8	36.7	16.5	27	12.7	160	9.7	0782702000	24-SDS-S12-U7/8-14F
S 14	9/16-18 UNF-2A	PN 630	17.7	7	37	19	24	10	75	6.8	0782712000	24-SDS-S14-U9/16-18F
S 14	3/4-16 UNF-2A	PN 630	23	10	38.2	19	24	11.2	100	7.6	0782722000	24-SDS-S14-U3/4-16F
S 16	3/4-16 UNF-2A	PN 630	23	12	38.2	18.5	27	11.2	100	8.1	0782732000	24-SDS-S16-U3/4-16F
S 16	7/8-14 UNF-2A	PN 630	27	12	37.5	15	30	14	160	8.7	0782742000	24-SDS-S16-U7/8-14F
S 16	1 1/16-12 UN-2A	PN 630	32	12	42	18.5	32	15	270	14.4	0782752000	24-SDS-S16-U11/16-12F
S 20	3/4-16 UNF-2A	PN 420	23	10	42.2	20.5	32	11.2	100	12.7	0782772000	24-SDS-S20-U3/4-16F
S 20	7/8-14 UNF-2A	PN 420	27	12	43.7	20.5	32	12.7	160	13.8	0782782000	24-SDS-S20-U7/8-14F
S 20	1 1/16-12 UN-2A	PN 420	32	16	46	20.5	32	15	270	15.0	0782792000	24-SDS-S20-U11/16-12F
S 20	1 5/16-12 UN-2A	PN 420	38.1	16	48	22.5	41	15	270	25.0	1782552000	24-SDS-S20-U15/16-12F
S 20	1 5/8-12 UN-2A	PN 420	48	16	48	22.5	50	15	450	36.5	1782412000	24-SDS-S20-U15/8-12F

Continued on following page



Straight male stud couplings

Male thread: UN/UNF

Sealing with O-ring

Standard O-ring material is NBR

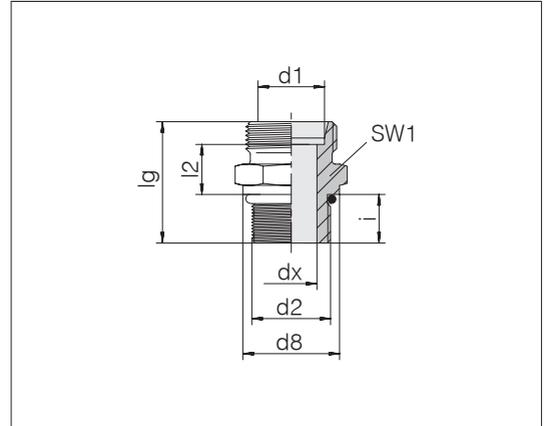

Series	d2	Pressure	d8	dx	lg	l2	SW1	i	Nm -10 %	kg/100 ca.	Order-No.	Designation
S 25	1 1/16-12 UN-2A	PN 420	32	16	50	23	41	15	270	23.5	0782942000	24-SDS-S25-U11/16-12F
S 25	1 5/16-12 UN-2A	PN 420	38.1	20	50	23	41	15	270	25.7	0782802000	24-SDS-S25-U15/16-12F
S 30	1 1/16-12 UN-2A	PN 420	32	16	52	23.5	46	15	270	30.1	0782812000	24-SDS-S30-U11/16-12F
S 30	1 5/16-12 UN-2A	PN 420	38.1	22	52	23.5	46	15	430	30.7	0782822000	24-SDS-S30-U15/16-12F
S 30	1 5/8-12 UN-2A	PN 420	48	25	52	23.5	50	15	450	38.1	0782852000	24-SDS-S30-U15/8-12F
S 38	1 5/8-12 UN-2A	PN 315	48	32	57	26	55	15	450	51.6	0782952000	24-SDS-S38-U15/8-12F
S 38	1 7/8-12 UN-2A	PN 315	54	32	57	26	55	15	520	51.9	0782832000	24-SDS-S38-U17/8-12F

Straight male stud couplings

Male thread: metric fine thread, parallel
ISO 6149

Sealing with O-ring

Standard O-ring material is NBR

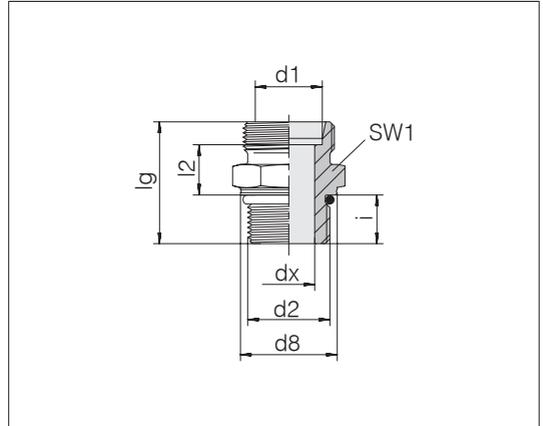

Series	d2	Pressure	d8	dx	lg	l2	SW1	i	Nm -10 %	kg/100 ca.	Order-No.	Designation	
Tube OD d1													
L 6	M 10 x 1	PN 500	13.8	4	25	9.5	14	8.5	15	1.5	0746002000	24-SDS-L6-M10F	•
L 6	M 14 x 1.5	PN 500	18.8	4	28	10	19	11	35	2.6	0746012000	24-SDS-L6-M14F	
L 8	M 10 x 1	PN 500	13.8	4	25.5	10	17	8.5	15	2.1	0746092000	24-SDS-L8-M10F	
L 8	M 12 x 1.5	PN 500	16.8	6	28	10	17	11	25	2.2	0746052000	24-SDS-L8-M12F	•
L 8	M 14 x 1.5	PN 500	18.8	6	28	10	19	11	35	3.1	0746072000	24-SDS-L8-M14F	
L 8	M 18 x 1.5	PN 400	23.8	6	31	11.5	24	12.5	45	5.1	0746062000	24-SDS-L8-M18F	
L 10	M 10 x 1	PN 500	13.8	4	26.5	11	17	8.5	15	2.3	0746082000	24-SDS-L10-M10F	
L 10	M 12 x 1.5	PN 500	16.8	6	29	11	17	11	25	2.4	0746122000	24-SDS-L10-M12F	
L 10	M 14 x 1.5	PN 500	18.8	7	29	11	19	11	35	2.9	0746102000	24-SDS-L10-M14F	•
L 10	M 16 x 1.5	PN 400	21.8	8	31	12.5	22	11.5	40	4.0	0746132000	24-SDS-L10-M16F	
L 10	M 18 x 1.5	PN 400	23.8	8	32	12.5	24	12.5	45	5.2	0746142000	24-SDS-L10-M18F	
L 10	M 22 x 1.5	PN 400	26.8	7	34	14	27	13	60	6.6	0746112000	24-SDS-L10-M22F	
L 12	M 12 x 1.5	PN 400	16.8	6	30.5	12.5	19	11	25	3.0	0746162000	24-SDS-L12-M12F	
L 12	M 14 x 1.5	PN 400	18.8	7	31	13	19	11	35	3.2	0746172000	24-SDS-L12-M14F	
L 12	M 16 x 1.5	PN 400	21.8	9	31	12.5	22	11.5	40	4.0	0746152000	24-SDS-L12-M16F	•
L 12	M 18 x 1.5	PN 400	23.8	9	32	12.5	24	12.5	45	5.1	0746192000	24-SDS-L12-M18F	
L 12	M 22 x 1.5	PN 400	26.8	10	34	14	27	13	60	7.6	0746182000	24-SDS-L12-M22F	
L 15	M 14 x 1.5	PN 400	18.8	7	31.5	13.5	24	11	35	4.8	0746212000	24-SDS-L15-M14F	
L 15	M 16 x 1.5	PN 400	21.8	9	32.5	14	22	11.5	40	5.4	0746242000	24-SDS-L15-M16F	
L 15	M 18 x 1.5	PN 400	23.8	11	33	13.5	24	12.5	45	5.2	0746202000	24-SDS-L15-M18F	•
L 15	M 22 x 1.5	PN 400	26.8	12	35	15	27	13	60	7.7	0746222000	24-SDS-L15-M22F	
L 18	M 18 x 1.5	PN 400	23.8	11	34.5	14.5	27	12.5	45	7.6	0746262000	24-SDS-L18-M18F	
L 18	M 22 x 1.5	PN 400	26.8	14	35	14.5	27	13	60	7.5	0746252000	24-SDS-L18-M22F	•
L 22	M 22 x 1.5	PN 400	26.8	14	37	16.5	32	13	60	11.3	0746312000	24-SDS-L22-M22F	
L 22	M 27 x 2	PN 250	31.8	18	40	16.5	32	16	100	10.5	0746302000	24-SDS-L22-M27F	•
L 22	M 33 x 2	PN 250	40.8	19	41	17.5	41	16	160	18.4	0746322000	24-SDS-L22-M33F	
L 22	M 42 x 2	PN 250	49.8	19	42	18.5	50	16	210	25.7	0746332000	24-SDS-L22-M42F	
L 28	M 27 x 2	PN 250	31.8	18	40	16.5	36	16	100	13.6	0746372000	24-SDS-L28-M27F	
L 28	M 33 x 2	PN 250	40.8	23	41	17.5	41	16	160	16.4	0746352000	24-SDS-L28-M33F	•

• Standard size

Example for comp. :
GEO06LMOMD
ISO 8434-1-SDS-L6xM10x1-F-St

Continued on following page



Straight male stud couplings

Male thread: metric fine thread, parallel
ISO 6149

Sealing with O-ring

Standard O-ring material is NBR

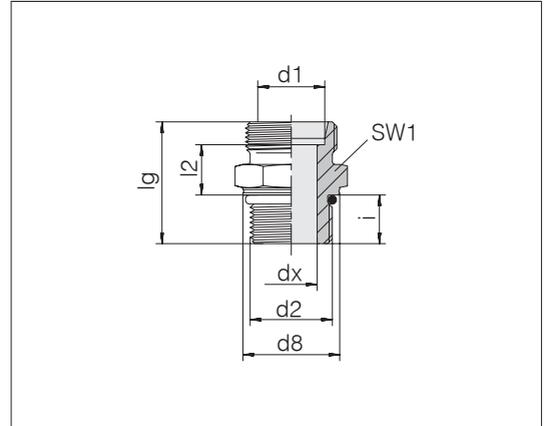

Series	d2	Pressure	d8	dx	lg	l2	SW1	i	Nm -10 %	kg/100 ca.	Order-No.	Designation	
L	35	M 33 x 2	PN 250	40.8	23	44	17.5	46	16	160	25.9	0746422000	24-SDS-L35-M33F
L	35	M 42 x 2	PN 250	49.8	30	44	17.5	50	16	210	26.5	0746402000	24-SDS-L35-M42F
L	35	M 48 x 2	PN 250	54.8	30	47.5	19.5	55	17.5	260	36.1	0746432000	24-SDS-L35-M48F
L	42	M 42 x 2	PN 250	49.8	30	46	19	55	16	210	37.4	0746412000	24-SDS-L42-M42F
L	42	M 48 x 2	PN 250	54.8	36	47.5	19	55	17.5	260	33.0	0746452000	24-SDS-L42-M48F
S	6	M 12 x 1.5	PN 800	16.8	4	31	13	17	11	35	2.9	0746502000	24-SDS-S6-M12F
S	8	M 10 x 1	PN 800	13.8	3	29.5	13	17	9.5	15	3.2	0746572000	24-SDS-S8-M10F
S	8	M 12 x 1.5	PN 800	16.8	4	33	15	17	11	35	3.9	0746562000	24-SDS-S8-M12F
S	8	M 14 x 1.5	PN 800	18.8	5	33	15	19	11	40	4.1	0746552000	24-SDS-S8-M14F
S	10	M 16 x 1.5	PN 800	21.8	7	35	15	22	12.5	55	5.5	0746602000	24-SDS-S10-M16F
S	12	M 14 x 1.5	PN 630	18.8	5	35.5	17	22	11	40	5.9	0746672000	24-SDS-S12-M14F
S	12	M 16 x 1.5	PN 630	21.8	7	35.5	15.5	22	12.5	55	6.0	0746662000	24-SDS-S12-M16F
S	12	M 18 x 1.5	PN 630	23.8	8	38.5	17	24	14	70	7.5	0746652000	24-SDS-S12-M18F
S	12	M 22 x 1.5	PN 630	26.8	8	40	17.5	27	15	100	11.3	0746682000	24-SDS-S12-M22F
S	16	M 22 x 1.5	PN 630	26.8	12	42	18.5	27	15	100	9.9	0746752000	24-SDS-S16-M22F
S	16	M 27 x 2	PN 420	31.8	12	47.5	20.5	32	18.5	170	17.1	0746772000	24-SDS-S16-M27F
S	20	M 22 x 1.5	PN 630	26.8	12	46	20.5	32	15	100	19.0	0746812000	24-SDS-S20-M22F
S	20	M 27 x 2	PN 420	31.8	15	49.5	20.5	32	18.5	170	16.4	0746802000	24-SDS-S20-M27F
S	20	M 33 x 2	PN 420	40.8	16	51.5	22.5	41	18.5	310	27.4	0746832000	24-SDS-S20-M33F
S	25	M 27 x 2	PN 420	31.8	15	53	22.5	41	18.5	170	25.7	0746842000	24-SDS-S25-M27F
S	25	M 33 x 2	PN 420	40.8	20	53.5	23	41	18.5	310	26.9	0746852000	24-SDS-S25-M33F
S	30	M 33 x 2	PN 420	40.8	20	55.5	23.5	46	18.5	310	33.7	0746912000	24-SDS-S30-M33F
S	30	M 42 x 2	PN 420	49.8	25	56	23.5	50	19	330	49.3	0746902000	24-SDS-S30-M42F
S	38	M 48 x 2	PN 420	54.8	32	63.5	26	55	21.5	420	57.1	0746952000	24-SDS-S38-M48F

● Standard size

Double nipple

Male thread on both sides: Whitworth pipe thread, parallel

Sealing with PEFLEX profile seal ring

Standard profile seal ring material is NBR

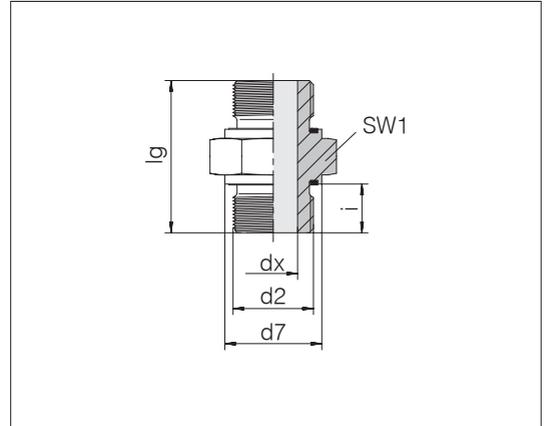

d2	Pressure	d7	dx	lg	SW1	i	Nm -10 %	kg/100 ca.	Order-No.	Designation
G 1/8 A	PN 315	13.9	4	23	14	8	20	1.6	1794682000	GP-SD2S-G1/8E-G1/8E-ID4
G 1/4 A	PN 630	18.9	5	34	19	12	60	3.9	1794672000	GP-SD2S-G1/4E-G1/4E
G 3/8 A	PN 630	21.9	8	38.5	22	12	90	6.5	1798262000	GP-SD2S-G3/8E-G3/8E
G 1/2 A	PN 630	26.9	12	40	27	14	150	9.1	1799072000	GP-SD2S-G1/2E-G1/2E
G 3/4 A	PN 420	31.9	16	50	36	16	200	17.6	1796692000	GP-SD2S-G3/4E-G3/4E
G 1 A	PN 420	39.9	20	56	41	18	250	30.0	1794662000	GP-SD2S-G1E-G1E
G 1 1/4 A	PN 420	49.9	25	60	50	20	500	50.0	1794652000	GP-SD2S-G11/4E-G11/4E
G 1 1/2 A	PN 420	54.9	32	67	55	22	600	62.0	1794642000	GP-SD2S-G11/2E-G11/2E
G 2 A	PN 160	74.9	40	73	70	20	700	105.7	1794632000	GP-SD2S-G2E-G2E

Double nipple

Male thread on both sides: Whitworth pipe thread, parallel

Reduction

Sealing with PEFLEX profile seal ring

Standard profile seal ring material is NBR

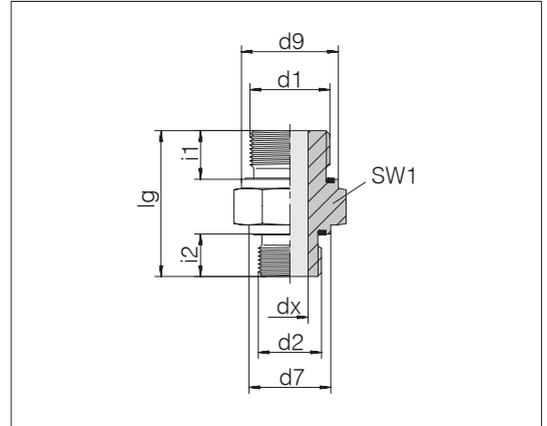

d1	d2	Pressure	d7	d9	dx	lg	SW1	i1	i2	kg/100 ca.	Nm -10 % (d1)	Order-No.	Designation
G 1/4 A	G 1/8 A	PN 315	13.9	18.9	4	29.5	19	12	8	3.4	60	1794302000	GP-SD2S-G1/4E-G1/8E-ID4
G 3/8 A	G 1/4 A	PN 630	18.9	21.9	5	36.5	22	12	12	6.1	90	1794312000	GP-SD2S-G3/8E-G1/4E
G 1/2 A	G 3/8 A	PN 630	21.9	26.9	8	41.5	27	14	12	9.8	150	1798882000	GP-SD2S-G1/2E-G3/8E
G 3/4 A	G 1/2 A	PN 420	26.9	31.9	12	48	32	16	14	16.8	200	1794322000	GP-SD2S-G3/4E-G1/2E
G 1 A	G 3/4 A	PN 420	31.9	39.9	16	54	41	18	16	29.4	250	1794332000	GP-SD2S-G1E-G3/4E
G 1 1/4 A	G 1 A	PN 420	39.9	49.9	20	58	50	20	18	47.8	500	1794342000	GP-SD2S-G11/4E-G1E
G 1 1/2 A	G 1 1/4 A	PN 420	49.9	54.9	25	65	55	22	20	69.1	600	1794352000	GP-SD2S-G11/2E-G11/4E
G 2 A	G 1 1/2 A	PN 160	54.9	74.9	32	70	70	24	22	107.6	700	1794362000	GP-SD2S-G2E-G11/2E

Elbow male stud couplings

Male thread: metric fine thread, tapered

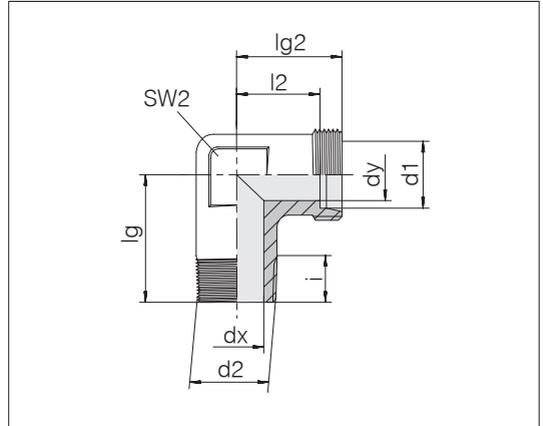

Series	d2	Pressure	dx	dy	lg	lg2	l2	SW2	i	kg/100 ca.	Order-No.	Designation
Tube OD d1												
LL 4	M 6 x 1 keg	PN 100	2.5	3	17	15	11	9	8	1.0	0713012000	24-SDE-LL4-M6T
LL 4	M 8 x 1 keg	PN 100	3.5	3	17	15	11	9	8	0.9	0713002000	24-SDE-LL4-M8T
LL 5	M 8 x 1 keg	PN 100	3.5	3.5	17	15	9.5	11	8	1.7	0713052000	24-SDE-LL5-M8T-P
LL 6	M 6 x 1 keg	PN 100	2.3	4.5	17	15	9.5	11	8	1.5	0713962000	24-SDE-LL6-M6T-P
LL 6	M 8 x 1 keg	PN 100	3.5	4.5	17	15	9.5	11	8	1.6	0713112000	24-SDE-LL6-M8T-P
LL 6	M 10 x 1 keg	PN 100	4.5	4.5	17	15	9.5	11	8	1.7	0713102000	24-SDE-LL6-M10T-P
LL 8	M 10 x 1 keg	PN 100	6	6	20	17	11.5	12	8	2.2	0713152000	24-SDE-LL8-M10T-P
L 6	M 10 x 1 keg	PN 315	4	4	20	19	12	12	8	2.9	0714002000	24-SDE-L6-M10T-P
L 8	M 12 x 1.5 keg	PN 315	6	6	26	21	14	14	12	4.3	0714052000	24-SDE-L8-M12T-P
L 10	M 14 x 1.5 keg	PN 315	7	8	27	22	15	17	12	6.2	0714102000	24-SDE-L10-M14T-P
L 12	M 16 x 1.5 keg	PN 315	9	10	28	24	17	19	12	8.5	0714152000	24-SDE-L12-M16T-P
L 12	M 18 x 1.5 keg	PN 315	11	10	32	28	21	19	12	8.2	0714172000	24-SDE-L12-M18T
L 15	M 18 x 1.5 keg	PN 315	11	12	32	28	21	19	12	8.3	0714202000	24-SDE-L15-M18T
L 18	M 22 x 1.5 keg	PN 315	14	15	36	31	23.5	24	14	13.0	0714252000	24-SDE-L18-M22T
S 6	M 12 x 1.5 keg	PB 630	4	4	26	23	16	14	12	5.2	0714502000	24-SDE-S6-M12T-P
S 8	M 14 x 1.5 keg	PB 630	5	5	27	24	17	17	12	7.4	0714552000	24-SDE-S8-M14T-P
S 10	M 16 x 1.5 keg	PB 630	7	7	28	25	17.5	19	12	10.1	0714602000	24-SDE-S10-M16T-P
S 12	M 18 x 1.5 keg	PB 630	8	8	28	29	21.5	22	12	12.9	0714652000	24-SDE-S12-M18T-P
S 14	M 20 x 1.5 keg	PB 630	10	10	32	30	22	19	14	10.4	0714702000	24-SDE-S14-M20T
S 16	M 22 x 1.5 keg	PB 400	12	12	32	33	24.5	24	14	14.5	0714752000	24-SDE-S16-M22T

● Standard size

Operating pressure PB 630 only applies if holes with female conical threads are available.

Example for comp. :
WE06LMX
DIN 2353-FL6-St



Elbow male stud couplings

Male thread: Whitworth pipe thread, tapered

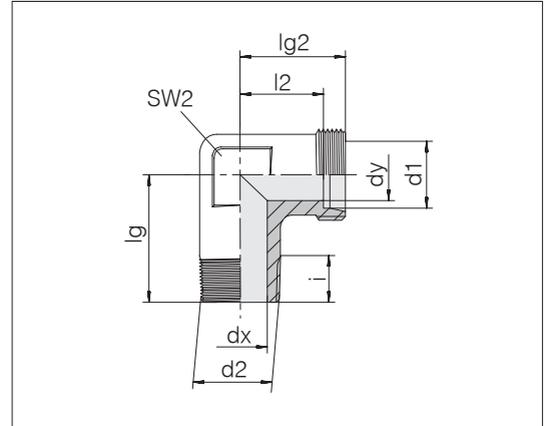

Series	Tube OD	d2	Pressure	dx	dy	lg	lg2	l2	SW2	i	kg/100 ca.	Order-No.	Designation	
LL	4	R 1/8	PN 100	4	3	17	15	11	11	8	1.0	0715002000	24-SDE-LL4-R1/8T	•
LL	5	R 1/8	PN 100	4	3.5	17	15	9.5	11	8	1.8	0715052000	24-SDE-LL5-R1/8T-P	•
LL	6	R 1/8	PN 100	4.5	4.5	17	15	9.5	11	8	1.6	0715102000	24-SDE-LL6-R1/8T-P	•
LL	8	R 1/8	PN 100	6	6	20	17	11.5	12	8	2.2	0715152000	24-SDE-LL8-R1/8T-P	•
L	6	R 1/8	PN 315	4	4	20	19	12	12	8	2.7	0716002000	24-SDE-L6-R1/8T-P	•
L	6	R 1/4	PN 315	7	4	26	14	14	14	12	4.5	0716022000	24-SDE-L6-R1/4T-P	•
L	6	R 3/8	PN 315	9	4	27	24	17	17	12	6.8	0716032000	24-SDE-L6-R3/8T-P	•
L	8	R 1/8	PN 315	4	6	26	21	14	14	8	4.6	0716062000	24-SDE-L8-R1/8T-P	•
L	8	R 1/4	PN 315	6	6	26	21	14	14	12	4.8	0716052000	24-SDE-L8-R1/4T-P	•
L	8	R 3/8	PN 315	8	6	28	22	15	19	15	8.8	0716072000	24-SDE-L8-R3/8T-P	•
L	10	R 1/8	PN 315	4	7	25	22	15	17	8	6.7	0716112000	24-SDE-L10-R1/8T-P	•
L	10	R 1/4	PN 315	7	8	27	22	15	17	12	5.9	0716102000	24-SDE-L10-R1/4T-P	•
L	10	R 3/8	PN 315	7	7	28	23	16	19	15	9.3	0716122000	24-SDE-L10-R3/8T-P	•
L	10	R 1/2	PN 315	11	7	34	27	20	19	10	9.6	0716132000	24-SDE-L10-R1/2T	•
L	12	R 1/4	PN 315	7	9	28	24	17	19	12	8.5	0716162000	24-SDE-L12-R1/4T-P	•
L	12	R 3/8	PN 315	9	10	28	24	17	19	12	9.1	0716152000	24-SDE-L12-R3/8T-P	•
L	12	R 1/2	PN 315	11	9	34	27	20	19	14	9.7	0716172000	24-SDE-L12-R1/2T	•
L	15	R 3/8	PN 315	9	11	32	28	21	19	12	9.0	0716212000	24-SDE-L15-R3/8T	•
L	15	R 1/2	PN 315	11	12	34	28	21	19	14	9.5	0716202000	24-SDE-L15-R1/2T	•
L	15	R 3/4	PN 160	16	12	42	28.5	21.5	27	16	18.6	0716222000	24-SDE-L15-R3/4T	•
L	18	R 1/2	PN 315	14	15	36	31	23.5	24	14	12.6	0716252000	24-SDE-L18-R1/2T	•
L	18	R 3/4	PN 160	18	15	42	35	27.5	27	16	20.2	0716272000	24-SDE-L18-R3/4T	•
L	22	R 3/4	PN 160	18	19	42	27.5	27.5	27	16	17.3	0716342000	24-SDE-L22-R3/4T	•

• Standard size

Example for comp. :
WE06LRX
DIN 2353-GL6-St

Continued on following page

Elbow male stud couplings

Male thread: Whitworth pipe thread, tapered

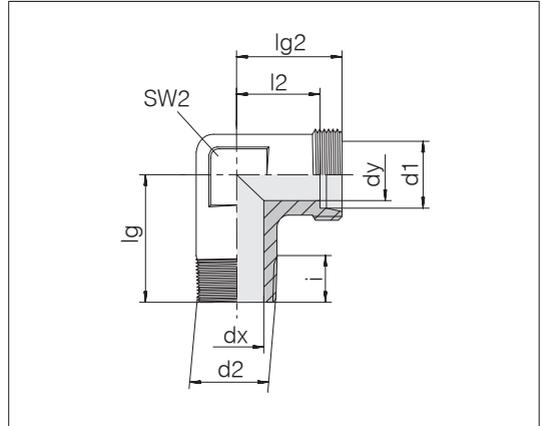

Series	d2	Pressure	dx	dy	lg	lg2	l2	SW2	i	kg/100 ca.	Order-No.	Designation
Tube OD d1												
S 6	R 1/4	PB 630	4	4	26	23	16	14	12	5.4	0716502000	24-SDE-S6-R1/4T-P •
S 8	R 1/4	PB 630	5	5	27	24	17	17	12	7.0	0716552000	24-SDE-S8-R1/4T-P •
S 10	R 1/4	PB 630	5	7	27	25	17.5	19	12	9.3	0716612000	24-SDE-S10-R1/4T-P •
S 10	R 3/8	PB 630	7	7	28	25	17.5	19	12	10.2	0716602000	24-SDE-S10-R3/8T-P •
S 10	R 1/2	PB 630	10	7	34	27	19.5	19	16	11.5	0716622000	24-SDE-S10-R1/2T-P •
S 12	R 3/8	PB 630	8	8	28	29	21.5	22	12	12.7	0716652000	24-SDE-S12-R3/8T-P •
S 12	R 1/2	PB 630	11	8	34	29	21.5	19	14	10.3	0716672000	24-SDE-S12-R1/2T •
S 14	R 1/4	PB 630	7	10	30	30	22	19	12	9.3	0716732000	24-SDE-S14-R1/4T •
S 14	R 3/8	PB 630	8	10	30	30	22	19	12	9.7	0716712000	24-SDE-S14-R3/8T •
S 14	R 1/2	PB 630	10	10	32	30	22	19	14	10.5	0716702000	24-SDE-S14-R1/2T •
S 16	R 1/2	PB 400	12	12	32	33	24.5	24	14	13.9	0716752000	24-SDE-S16-R1/2T •
S 16	R 3/4	PB 400	16	12	42	33	24.5	27	16	18.9	0716772000	24-SDE-S16-R3/4T •
S 20	R 1/2	PB 400	12	16	40	37	26.5	27	14	21.6	0716812000	24-SDE-S20-R1/2T •
S 20	R 3/4	PB 400	16	16	42	37	26.5	27	16	21.7	0716842000	24-SDE-S20-R3/4T •

• Standard size

Operating pressure PB 630 only
applies if holes with
female conical threads are available.



Elbow male stud couplings

Male thread: NPT (ANSI/ASME B 1 - 20.01.1983)

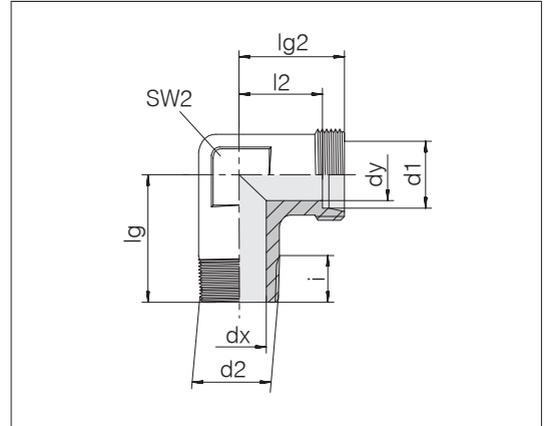

Series	Tube OD	d2	Pressure	dx	dy	lg	lg2	l2	SW2	i	Nm -10 %	kg/100 ca.	Order-No.	Designation	
LL	4	1/8 NPT	PN 100	3	3	17	15	11	11	9.9	15	1.8	0717002000	24-SDE-LL4-N1/8T-P	•
LL	6	1/8 NPT	PN 100	4.5	4.5	17	15	9.5	11	9.9	15	1.7	0717102000	24-SDE-LL6-N1/8T-P	•
LL	8	1/8 NPT	PN 100	6	6	20	17	11.5	12	9.9	15	2.4	0717152000	24-SDE-LL8-N1/8T-P	•
L	6	1/8 NPT	PN 315	4	4	20	19	12	12	9.9	15	3.0	0718002000	24-SDE-L6-N1/8T-P	•
L	6	1/4 NPT	PN 315	4	4	26	21	14	14	15.1	35	4.9	0718022000	24-SDE-L6-N1/4T-P	•
L	8	1/4 NPT	PN 315	6	6	26	21	14	14	15.1	35	4.7	0718052000	24-SDE-L8-N1/4T-P	•
L	10	1/4 NPT	PN 315	7	7	27	22	15	17	15.1	35	6.2	0718102000	24-SDE-L10-N1/4T-P	•
L	10	3/8 NPT	PN 315	9	8	28	24	17	19	15.1	55	9.1	0718122000	24-SDE-L10-N3/8T-P	•
L	12	1/4 NPT	PN 315	7	9	28	24	17	19	15.1	35	8.6	0718162000	24-SDE-L12-N1/4T-P	•
L	12	3/8 NPT	PN 315	9	9	28	24	17	19	15.2	55	9.0	0718152000	24-SDE-L12-N3/8T-P	•
L	12	1/2 NPT	PN 315	12	9	33	28	21	24	19.8	110	12.3	0718172000	24-SDE-L12-N1/2T	•
L	15	1/2 NPT	PN 315	11	11	36	31	24	24	19.8	110	14.2	0718202000	24-SDE-L15-N1/2T	•
L	18	1/2 NPT	PN 315	14	14	37	31	23.5	24	19.8	110	12.9	0718252000	24-SDE-L18-N1/2T	•
L	22	3/4 NPT	PN 160	18	19	42	35	27.5	27	20.1	175	17.4	0718302000	24-SDE-L22-N3/4T	•
L	28	1 NPT	PN 160	23	24	48	38	30.5	36	25	265	28.5	0718352000	24-SDE-L28-N1T	•
L	35	1 1/4 NPT	PN 160	30	30	54	45	34.5	41	25.6	315	47.7	0718402000	24-SDE-L35-N11/4T	•
L	42	1 1/2 NPT	PN 160	36	36	61	51	40	50	26	385	72.3	0718452000	24-SDE-L42-N11/2T	•
S	6	1/4 NPT	PN 630	4	4	26	23	16	14	15.1	35	5.6	0718502000	24-SDE-S6-N1/4T-P	•
S	8	1/4 NPT	PN 630	5	5	27	24	17	17	15.1	35	7.3	0718552000	24-SDE-S8-N1/4T-P	•
S	10	3/8 NPT	PN 630	7	7	28	25	17.5	19	15.2	55	10.4	0718602000	24-SDE-S10-N3/8T-P	•
S	12	3/8 NPT	PN 630	8	8	29	29	21.5	22	15.2	55	12.6	0718652000	24-SDE-S12-N3/8T-P	•
S	14	1/2 NPT	PN 630	10	10	33	33	25	24	19.8	110	14.9	0718702000	24-SDE-S14-N1/2T	•
S	16	1/2 NPT	PN 400	12	12	36	33	24.5	24	19.8	110	14.6	0718752000	24-SDE-S16-N1/2T	•
S	20	3/4 NPT	PN 400	16	16	42	37	26.5	27	20.1	175	21.5	0718802000	24-SDE-S20-N3/4T	•
S	25	1 NPT	PN 400	20	20	49	42	30	36	25	265	37.6	0718852000	24-SDE-S25-N1T	•
S	30	1 1/4 NPT	PN 400	25	25	54	49	35.5	41	25.6	315	64.8	0718902000	24-SDE-S30-N11/4T	•
S	38	1 1/2 NPT	PN 315	32	32	61	57	41	50	26	385	97.1	0718952000	24-SDE-S38-N11/2T	•

• Standard size

Example for comp. :
WE06L1/8NPTX

L male stud couplings

Male thread: metric fine thread, tapered

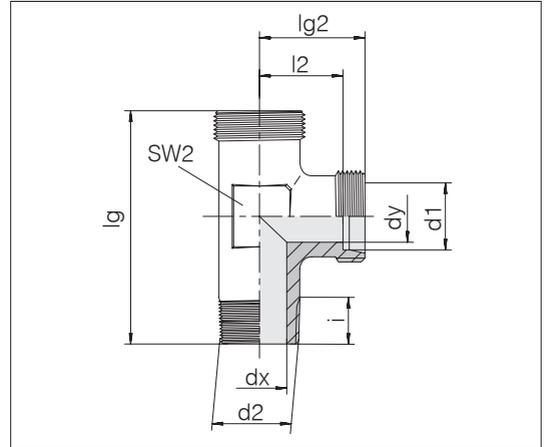

Series	Tube OD	d2	Pressure	dx	dy	lg	lg2	l2	SW2	i	kg/100 ca.	Order-No.	Designation
LL	4	M 8 x 1 keg	PN 100	3.5	20	32	15	11	9	8	1.2	0721002000	24-SDL-LL4-M8T
LL	6	M 10 x 1 keg	PN 100	4.5	20	32	15	9.5	9	8	1.2	0721102000	24-SDL-LL6-M10T
LL	8	M 10 x 1 keg	PN 100	6	20	37	17	11.5	12	8	2.8	0721152000	24-SDL-LL8-M10T-P
L	6	M 10 x 1 keg	PN 315	4	20	39	19	12	12	8	3.8	0722002000	24-SDL-L6-M10T-P
L	8	M 12 x 1.5 keg	PN 315	6	20	47	21	14	14	12	5.4	0722052000	24-SDL-L8-M12T-P
L	10	M 14 x 1.5 keg	PN 315	7	20	49	22	15	17	12	7.2	0722102000	24-SDL-L10-M14T-P
L	12	M 16 x 1.5 keg	PN 315	9	20	52	24	17	19	12	10.1	0722152000	24-SDL-L12-M16T-P
L	15	M 18 x 1.5 keg	PN 315	11	20	60	28	21	19	12	10.4	0722202000	24-SDL-L15-M18T
L	18	M 22 x 1.5 keg	PN 315	14	20	67	31	23.5	24	14	16.5	0722252000	24-SDL-L18-M22T
S	6	M 12 x 1.5 keg	PB 630	4	20	49	23	16	14	12	7.0	0722502000	24-SDL-S6-M12T-P
S	8	M 14 x 1.5 keg	PB 630	5	20	51	24	17	17	12	9.3	0722552000	24-SDL-S8-M14T-P
S	10	M 16 x 1.5 keg	PB 630	7	20	53	25	17.5	19	12	11.8	0722602000	24-SDL-S10-M16T-P
S	12	M 18 x 1.5 keg	PB 630	8	20	57	29	21.5	22	12	16.8	0722652000	24-SDL-S12-M18T-P
S	14	M 20 x 1.5 keg	PB 630	10	20	62	30	22	19	14	13.2	0722702000	24-SDL-S14-M20T
S	16	M 22 x 1.5 keg	PB 400	12	20	65	33	24.5	24	14	16.5	0722752000	24-SDL-S16-M22T

Operating pressure PB 630 only applies if holes with female conical threads are available.

Example for comp. :
LE06LMX
DIN 2353-AAL6-St



L male stud couplings

Male thread: Whitworth pipe thread, tapered

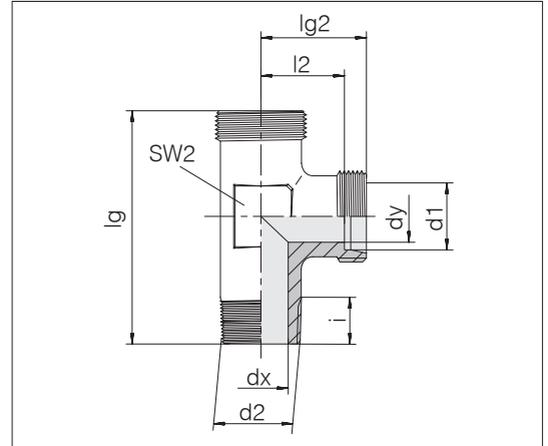

Series	Tube OD	d2	Pressure	dx	dy	lg	lg2	l2	SW2	i	kg/100 ca.	Order-No.	Designation
LL	4	R 1/8	PN 100	4	3	32	15	11	9	8	1.3	0723002000	24-SDL-LL4-R1/8T
LL	6	R 1/8	PN 100	4.5	4.5	32	15	9.5	9	8	1.2	0723102000	24-SDL-LL6-R1/8T
LL	8	R 1/8	PN 100	6	6	37	17	11.5	12	8	2.8	0723152000	24-SDL-LL8-R1/8T-P
L	6	R 1/8	PN 315	4	4	39	19	12	12	8	3.7	0724002000	24-SDL-L6-R1/8T-P
L	8	R 1/4	PN 315	6	6	47	21	14	14	12	5.6	0724052000	24-SDL-L8-R1/4T-P
L	10	R 1/4	PN 315	7	8	49	22	15	17	12	7.3	0724102000	24-SDL-L10-R1/4T-P
L	12	R 3/8	PN 315	9	10	52	24	17	19	12	9.8	0724152000	24-SDL-L12-R3/8T-P
L	15	R 1/2	PN 315	11	12	62	28	21	19	14	11.7	0724202000	24-SDL-L15-R1/2T
L	18	R 1/2	PN 315	14	15	67	31	23.5	24	14	15.7	0724252000	24-SDL-L18-R1/2T
S	6	R 1/4	PB 630	4	4	49	23	16	14	12	12.1	0724502000	24-SDL-S6-R1/4T-P
S	8	R 1/4	PB 630	5	5	51	24	17	17	12	9.0	0724552000	24-SDL-S8-R1/4T-P
S	10	R 3/8	PB 630	7	7	53	25	17.5	19	12	11.9	0724602000	24-SDL-S10-R3/8T-P
S	12	R 3/8	PB 630	8	8	57	29	21.5	22	12	16.2	0724652000	24-SDL-S12-R3/8T-P
S	14	R 1/2	PB 630	10	10	62	30	22	19	14	13.7	0724702000	24-SDL-S14-R1/2T
S	16	R 1/2	PB 400	12	12	65	33	24.5	24	14	16.5	0724752000	24-SDL-S16-R1/2T

Operating pressure PB 630 only applies if holes with female conical threads are available.

Example for comp. :
LE06LRX
DIN 2353-ABL6-St

T male stud couplings

Male thread: metric fine thread, tapered

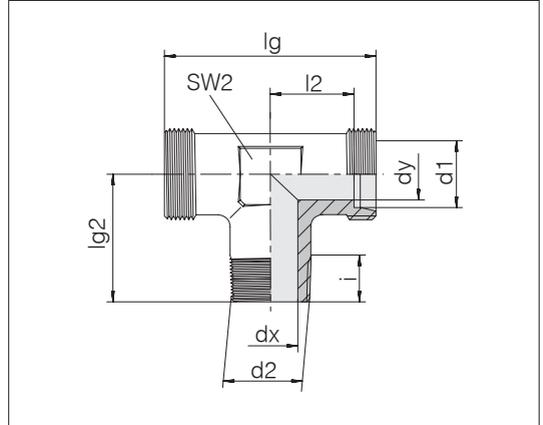

Series	d2	Pressure	dx	dy	lg	lg2	l2	SW2	i	kg/100 ca.	Order-No.	Designation
LL	4 M 8 x 1 keg	PN 100	3.5	3	30	17	11	9	8	1.2	0727002000	24-SDT-LL4-M8T
LL	6 M 10 x 1 keg	PN 100	4.5	4.5	30	17	9.5	9	8	1.2	0727102000	24-SDT-LL6-M10T
LL	8 M 10 x 1 keg	PN 100	6	6	34	20	11.5	12	8	2.8	0727152000	24-SDT-LL8-M10T-P
L	6 M 10 x 1 keg	PN 315	4	4	38	20	12	12	8	3.6	0728002000	24-SDT-L6-M10T-P
L	8 M 12 x 1.5 keg	PN 315	6	6	42	26	14	14	12	5.5	0728052000	24-SDT-L8-M12T-P
L	10 M 14 x 1.5 keg	PN 315	7	8	44	27	15	17	12	7.2	0728102000	24-SDT-L10-M14T-P
L	12 M 16 x 1.5 keg	PN 315	9	10	48	28	17	19	12	9.8	0728152000	24-SDT-L12-M16T-P
L	15 M 18 x 1.5 keg	PN 315	11	12	56	32	21	19	12	10.2	0728202000	24-SDT-L15-M18T
L	18 M 22 x 1.5 keg	PN 315	14	15	62	36	23.5	24	14	14.1	0728252000	24-SDT-L18-M22T
S	6 M 12 x 1.5 keg	PB 630	4	4	46	26	16	14	12	6.6	0728502000	24-SDT-S6-M12T-P
S	8 M 14 x 1.5 keg	PB 630	5	5	48	27	17	17	12	9.2	0728552000	24-SDT-S8-M14T-P
S	10 M 16 x 1.5 keg	PB 630	7	7	50	28	17.5	19	12	12.1	0728602000	24-SDT-S10-M16T-P
S	12 M 18 x 1.5 keg	PB 630	8	8	58	28	21.5	22	12	16.7	0728652000	24-SDT-S12-M18T-P
S	14 M 20 x 1.5 keg	PB 630	10	10	60	32	22	19	14	13.2	0728702000	24-SDT-S14-M20T
S	16 M 22 x 1.5 keg	PB 400	12	12	66	32	24.5	24	14	16.1	0728752000	24-SDT-S16-M22T

Operating pressure PB 630 only applies if holes with female conical threads are available.

Example for comp. :
TE06LMX
DIN 2353-ML6-St



T male stud couplings

Male thread: Whitworth pipe thread, tapered

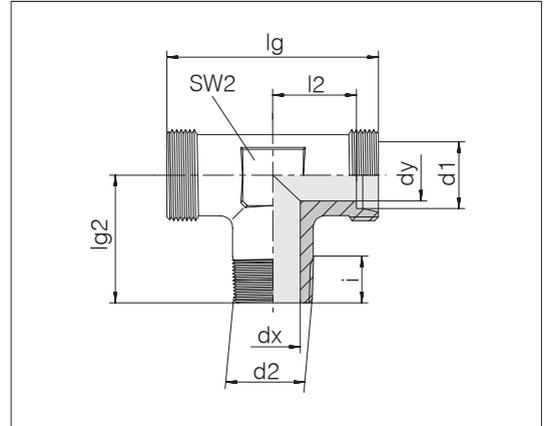

Series	d2	Pressure	dx	dy	lg	lg2	l2	SW2	i	kg/100 ca.	Order-No.	Designation
LL	4	R 1/8 PN 100	4	3	30	17	11	9	8	1.3	0729002000	24-SDT-LL4-R1/8T
LL	6	R 1/8 PN 100	4.5	4.5	30	17	9.5	9	8	1.2	0729102000	24-SDT-LL6-R1/8T
LL	8	R 1/8 PN 100	6	6	34	20	11.5	12	8	2.7	0729152000	24-SDT-LL8-R1/8T-P
L	6	R 1/8 PN 315	4	4	38	20	12	12	8	3.6	0730002000	24-SDT-L6-R1/8T-P
L	8	R 1/4 PN 315	6	6	42	26	14	14	12	5.8	0730052000	24-SDT-L8-R1/4T-P
L	10	R 1/4 PN 315	7	8	44	27	15	17	12	7.2	0730102000	24-SDT-L10-R1/4T-P
L	12	R 1/4 PN 315	7	9	48	28	17	19	12	10.2	0730162000	24-SDT-L12-R1/4T-P
L	12	R 3/8 PN 315	9	10	48	28	17	19	12	10.0	0730152000	24-SDT-L12-R3/8T-P
L	15	R 1/2 PN 315	11	12	56	34	21	19	14	11.6	0730202000	24-SDT-L15-R1/2T
L	18	R 1/2 PN 315	14	15	62	36	23.5	24	14	15.7	0730252000	24-SDT-L18-R1/2T
S	6	R 1/4 PB 630	4	4	46	26	16	14	12	7.1	0730502000	24-SDT-S6-R1/4T-P
S	8	R 1/4 PB 630	5	5	48	27	17	17	12	9.2	0730552000	24-SDT-S8-R1/4T-P
S	10	R 3/8 PB 630	7	7	50	28	17.5	19	12	12.1	0730602000	24-SDT-S10-R3/8T-P
S	12	R 3/8 PB 630	8	8	58	28	21.5	22	12	16.3	0730652000	24-SDT-S12-R3/8T-P
S	14	R 1/2 PB 630	10	10	60	32	22	19	14	13.8	0730702000	24-SDT-S14-R1/2T
S	16	R 1/2 PB 400	12	12	66	32	24.5	24	14	18.5	0730752000	24-SDT-S16-R1/2T

● Standard size

Operating pressure PB 630 only applies if holes with female conical threads are available.

Example for comp. :
TE06LRX
DIN 2353-NL6-St

Connecting adapters

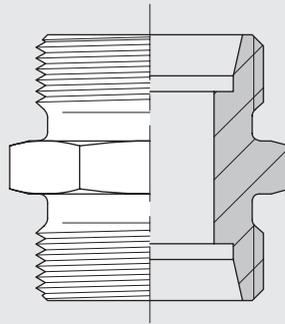

Straight couplings

For tube to tube connection according to
DIN 2353 / ISO 8434-1

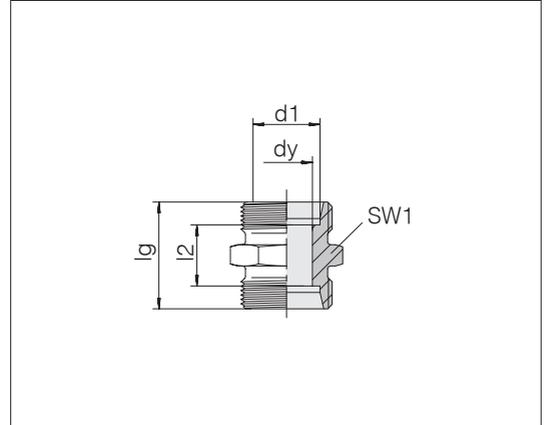

Series	Tube OD	Pressure	d_y	lg	l_2	SW1	kg/100 ca.	Order-No.	Designation
LL	4	PN 100	3	20	12	9	0.5	0711002000	24-S-LL4
LL	5	PN 100	3.5	20	9	11	0.8	0711052000	24-S-LL5
LL	6	PN 100	4.5	20	9	11	0.7	0711102000	24-S-LL6
LL	8	PN 100	6	23	12	12	1.0	0711152000	24-S-LL8
L	6	PN 500	4	24	10	12	1.2	0712002000	24-S-L6
L	8	PN 500	6	25	11	14	1.6	0712052000	24-S-L8
L	10	PN 500	8	27	13	17	2.2	0712102000	24-S-L10
L	12	PN 400	10	28	14	19	2.8	0712152000	24-S-L12
L	15	PN 400	12	30	16	24	4.9	0712202000	24-S-L15
L	18	PN 400	15	31	16	27	6.7	0712252000	24-S-L18
L	22	PN 250	19	35	20	32	8.8	0712302000	24-S-L22
L	28	PN 250	24	36	21	41	13.6	0712352000	24-S-L28
L	35	PN 250	30	41	20	46	21.0	0712402000	24-S-L35
L	42	PN 250	36	43	21	55	29.4	0712452000	24-S-L42
S	6	PN 800	4	30	16	14	2.5	0712502000	24-S-S6
S	8	PN 800	5	32	18	17	3.7	0712552000	24-S-S8
S	10	PN 800	7	32	17	19	4.3	0712602000	24-S-S10
S	12	PN 630	8	34	19	22	5.9	0712652000	24-S-S12
S	14	PN 630	10	38	22	24	7.5	0712702000	24-S-S14
S	16	PN 630	12	38	21	27	8.7	0712752000	24-S-S16
S	20	PN 420	16	44	23	32	14.2	0712802000	24-S-S20
S	25	PN 420	20	50	26	41	25.0	0712852000	24-S-S25
S	30	PN 420	25	54	27	46	32.3	0712902000	24-S-S30
S	38	PN 420	32	61	29	55	53.8	0712952000	24-S-S38

Example for comp. :
G06LX
ISO 8434-1-S-L6-St



Straight reducing couplings

For tube to tube connection according to
DIN 2353 / ISO 8434-1

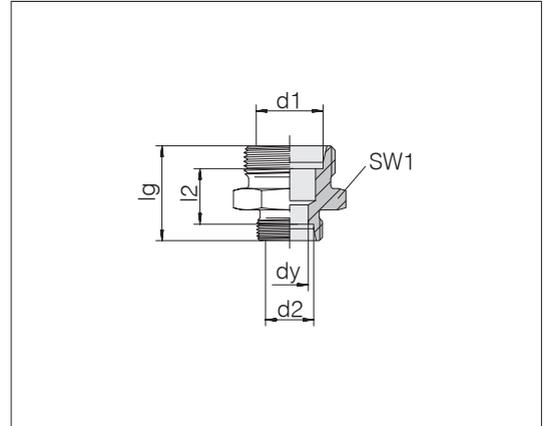

Series	Tube OD	Series	Tube OD	Pressure	dy	lg	l2	SW1	kg/100 ca.	Order-No.	Designation
d1	d2										
LL	6	LL	4	PN 100	3	20	10.5	11	0.7	0711122000	24-S-LL6-LL4
LL	8	LL	4	PN 100	3	22	12.5	12	0.9	0711182000	24-S-LL8-LL4
LL	8	LL	6	PN 100	4.5	22	11	12	1.1	0711192000	24-S-LL8-LL6
L	8	L	6	PN 500	4	25	11	14	1.5	0712062000	24-S-L8-L6
L	10	L	6	PN 500	4	26	12	17	2.0	0712122000	24-S-L10-L6
L	10	L	8	PN 500	6	26	12	17	2.1	0712112000	24-S-L10-L8
L	12	L	6	PN 400	4	27	13	19	2.5	0712182000	24-S-L12-L6
L	12	L	8	PN 400	6	27	13	19	2.6	0712172000	24-S-L12-L8
L	12	L	10	PN 400	8	28	14	19	2.7	0712162000	24-S-L12-L10
L	15	L	6	PN 400	4	28	14	24	3.8	0712242000	24-S-L15-L6
L	15	L	8	PN 400	6	28	14	24	4.0	0712232000	24-S-L15-L8
L	15	L	10	PN 400	8	29	15	24	4.1	0712222000	24-S-L15-L10
L	15	L	12	PN 400	10	29	15	24	4.2	0712212000	24-S-L15-L12
L	18	L	8	PN 400	6	29	14.5	27	6.0	0712292000	24-S-L18-L8
L	18	L	10	PN 400	8	30	15.5	27	5.6	0712282000	24-S-L18-L10
L	18	L	12	PN 400	10	30	15.5	27	5.7	0712272000	24-S-L18-L12
L	18	L	15	PN 400	12	31	16.5	27	6.1	0712262000	24-S-L18-L15
L	22	L	10	PN 250	8	32	17.5	32	7.5	0712342000	24-S-L22-L10
L	22	L	12	PN 250	10	32	17.5	32	7.6	0712332000	24-S-L22-L12
L	22	L	15	PN 250	12	33	18.5	32	8.1	0712322000	24-S-L22-L15
L	22	L	18	PN 250	15	33	18	32	8.6	0712312000	24-S-L22-L18
L	28	L	10	PN 250	8	33	18.5	41	12.2	0711822000	24-S-L28-L10
L	28	L	15	PN 250	12	34	19.5	41	12.2	0712382000	24-S-L28-L15
L	28	L	18	PN 250	15	34	19	41	12.3	0712372000	24-S-L28-L18
L	28	L	22	PN 250	19	36	21	41	13.2	0712362000	24-S-L28-L22
L	35	L	22	PN 250	19	39	21	46	19.0	0712422000	24-S-L35-L22
L	35	L	28	PN 250	24	39	21	46	19.0	0712412000	24-S-L35-L28
L	42	L	28	PN 250	24	41	22.5	55	26.8	0712472000	24-S-L42-L28
L	42	L	35	PN 250	30	43	21.5	55	29.3	0712462000	24-S-L42-L35

Straight reducing couplings

For tube to tube connection according to
DIN 2353 / ISO 8434-1

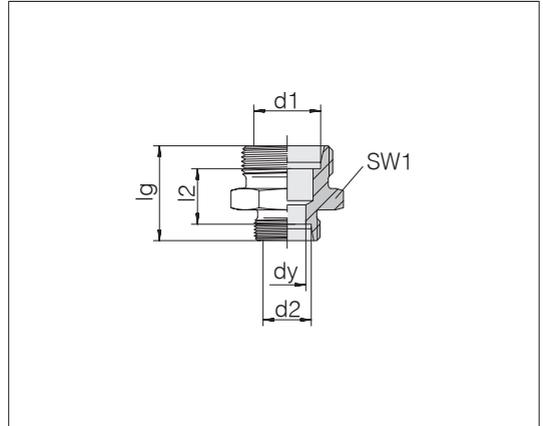

Series Tube OD d1	Series Tube OD d2	Pressure	dy	lg	l2	SW1	kg/100 ca.	Order-No.	Designation
S 8	S 6	PN 800	4	32	18	17	3.4	0712562000	24-S-S8-S6
S 10	S 6	PN 800	4	32	17.5	19	4.0	0712622000	24-S-S10-S6
S 10	S 8	PN 800	8	32	17.5	19	4.2	0712612000	24-S-S10-S8
S 12	S 6	PN 630	4	34	19.5	22	5.4	0712682000	24-S-S12-S6
S 12	S 8	PN 630	5	34	19.5	22	5.6	0712672000	24-S-S12-S8
S 12	S 10	PN 630	7	34	19	22	5.8	0712662000	24-S-S12-S10
S 14	S 10	PN 630	7	36	20.5	24	6.9	0712722000	24-S-S14-S10
S 14	S 12	PN 630	8	36	20.5	24	7.0	0712712000	24-S-S14-S12
S 16	L 12	PN 400	10	35	19.5	27	7.7	0711982000	24-S-S16-L12
S 16	L 15	PN 400	12	36	20.5	27	7.9	0799632000	24-S-S16-L15
S 16	S 8	PN 630	5	36	20.5	27	7.8	0712792000	24-S-S16-S8
S 16	S 10	PN 630	7	36	20	27	7.9	0712782000	24-S-S16-S10
S 16	S 12	PN 630	8	36	20	27	8.0	0712772000	24-S-S16-S12
S 16	S 14	PN 630	10	38	21.5	27	8.7	0712762000	24-S-S16-S14
S 20	L 15	PN 400	12	40	22.5	32	13.9	0796222000	24-S-S20-L15
S 20	S 10	PN 420	7	40	22	32	12.2	0712842000	24-S-S20-S10
S 20	S 12	PN 420	8	40	22	32	12.5	0712832000	24-S-S20-S12
S 20	S 14	PN 420	10	42	23.5	32	12.9	0712822000	24-S-S20-S14
S 20	S 16	PN 420	12	42	23	32	12.9	0712812000	24-S-S20-S16
S 25	S 16	PN 420	12	47	26.5	41	22.0	0712872000	24-S-S25-S16
S 25	S 20	PN 420	16	48	25.5	41	23.2	0712862000	24-S-S25-S20
S 30	S 20	PN 420	16	50	26	46	29.4	0712922000	24-S-S30-S20
S 30	S 25	PN 420	20	52	26.5	46	31.1	0712912000	24-S-S30-S25
S 38	S 25	PN 420	20	57	29	55	48.2	0712972000	24-S-S38-S25
S 38	S 30	PN 420	25	59	29.5	55	48.8	0712962000	24-S-S38-S30

Elbow couplings

For tube to tube connection according to
DIN 2353 / ISO 8434-1

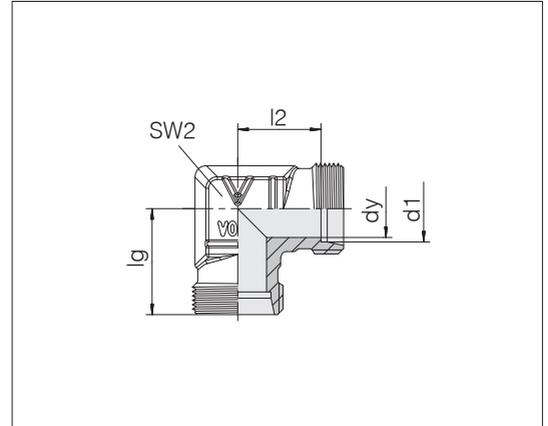

Series	Tube OD	Pressure	dy	lg	l2	SW2	kg/100 ca.	Order-No.	Designation
LL	4	PN 100	3	15	11	9	1.3	0719002000	24-E-LL4-P
LL	6	PN 100	4.5	15	9.5	11	1.5	0719102000	24-E-LL6-P
LL	8	PN 100	6	17	11.5	12	2.3	0719152000	24-E-LL8-P
L	6	PN 500	4	19	12	12	2.8	0720002000	24-E-L6-P
L	8	PN 500	6	21	14	14	4.1	0720052000	24-E-L8-P
L	10	PN 500	8	22	15	17	5.6	0720102000	24-E-L10-P
L	12	PN 400	10	24	17	19	7.7	0720152000	24-E-L12-P
L	15	PN 400	12	28	21	19	7.4	0720202000	24-E-L15
L	18	PN 400	15	31	23.5	24	11.9	0720252000	24-E-L18
L	22	PN 250	19	35	27.5	27	15.2	0720302000	24-E-L22
L	28	PN 250	24	38	30.5	36	25.1	0720352000	24-E-L28
L	35	PN 250	30	45	34.5	41	43.1	0720402000	24-E-L35
L	42	PN 250	36	51	40	50	78.2	0720452000	24-E-L42
S	6	PN 800	4	23	16	14	5.1	0720502000	24-E-S6-P
S	8	PN 800	5	24	17	17	7.2	0720552000	24-E-S8-P
S	10	PN 800	7	25	17.5	19	9.8	0720602000	24-E-S10-P
S	12	PN 630	8	29	21.5	22	14.4	0720652000	24-E-S12-P
S	14	PN 630	10	30	22	19	10.4	0720702000	24-E-S14
S	16	PN 630	12	33	24.5	24	12.7	0720752000	24-E-S16
S	20	PN 420	16	37	26.5	27	20.5	0720802000	24-E-S20
S	25	PN 420	20	42	30	36	34.9	0720852000	24-E-S25
S	30	PN 420	25	49	35.5	41	58.8	0720902000	24-E-S30
S	38	PN 420	32	57	41	50	103.1	0720952000	24-E-S38

Example for comp. :
W06LX
ISO 8434-1-E-L6-St

T couplings

Three sided tube connection according to
DIN 2353 / ISO 8434-1

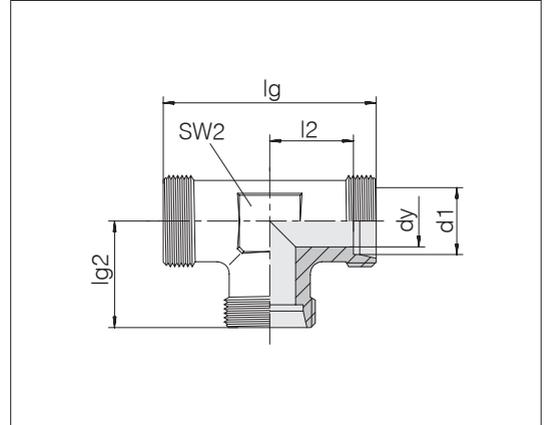

Series	Pressure	dy	lg	lg2	l2	SW2	kg/100 ca.	Order-No.	Designation
Tube OD d1									
LL 4	PN 100	3	30	15	11	9	1.1	0733002000	24-T-LL4
LL 5	PN 100	3.5	30	15	9.5	9	1.2	0733052000	24-T-LL5
LL 6	PN 100	4.5	30	15	9.5	9	1.0	0733102000	24-T-LL6
LL 8	PN 100	6	34	17	11.5	12	2.8	0733152000	24-T-LL8-P
L 6	PN 500	4	38	19	12	12	3.5	0734002000	24-T-L6-P
L 8	PN 500	6	42	21	14	14	5.1	0734052000	24-T-L8-P
L 10	PN 500	8	44	22	15	17	6.7	0734102000	24-T-L10-P
L 12	PN 400	10	48	24	17	19	9.1	0734152000	24-T-L12-P
L 15	PN 400	12	56	28	21	19	10.0	0734202000	24-T-L15
L 18	PN 400	15	62	31	23.5	24	15.0	0734252000	24-T-L18
L 22	PN 250	19	70	35	27.5	27	18.6	0734302000	24-T-L22
L 28	PN 250	24	76	38	30.5	36	29.9	0734352000	24-T-L28
L 35	PN 250	30	90	45	34.5	41	52.3	0734402000	24-T-L35
L 42	PN 250	36	102	51	40	50	91.5	0734452000	24-T-L42
S 6	PN 800	4	46	23	16	14	6.7	0734502000	24-T-S6-P
S 8	PN 800	5	48	24	17	17	9.1	0734552000	24-T-S8-P
S 10	PN 800	7	50	25	17.5	19	11.5	0734602000	24-T-S10-P
S 12	PN 630	8	58	29	21.5	22	17.3	0734652000	24-T-S12-P
S 14	PN 630	10	60	30	22	19	13.1	0734702000	24-T-S14
S 16	PN 630	12	66	33	24.5	24	16.5	0734752000	24-T-S16
S 20	PN 420	16	74	37	26.5	27	26.0	0734802000	24-T-S20
S 25	PN 420	20	84	42	30	36	43.6	0734852000	24-T-S25
S 30	PN 420	25	98	49	35.5	41	71.5	0734902000	24-T-S30
S 38	PN 420	32	114	57	41	50	125.8	0734952000	24-T-S38

Example for comp. :
T06LX
ISO 8434-1-T-L6-St



T reducing couplings

Three sided tube connection according to
DIN 2353 / ISO 8434-1

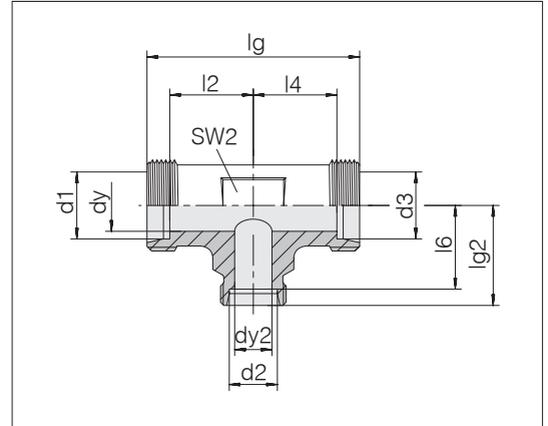

Series	Tube OD	d2	d3	Pressure	dy	dy2	lg	lg2	l2	l4	l6	SW2	kg/100 ca.	Order-No.	Designation
L	6	8	6	PN 500	4	6	42	21	14	14	14	14	5.1	0799772000	24-T-L6-L8-L6-P
L	6	10	6	PN 500	4	8	44	22	15	15	15	17	6.6	0799562000	24-T-L6-L10-L6-P
L	8	6	8	PN 500	6	4	42	21	14	14	14	14	5.2	0734062000	24-T-L8-L6-L8-P
L	8	8	6	PN 500	4	6	42	21	14	14	14	14	5.0	0799592000	24-T-L8-L8-L6-P
L	8	10	8	PN 500	6	8	44	22	15	15	15	17	6.9	0799762000	24-T-L8-L10-L8-P
L	8	12	8	PN 400	6	10	48	24	17	17	17	19	9.7	0799512000	24-T-L8-L12-L8-P
L	10	6	10	PN 500	8	4	44	22	15	15	15	17	6.6	0734122000	24-T-L10-L6-L10-P
L	10	6	6	PN 500	4	4	44	22	15	15	15	14	6.5	0799572000	24-T-L10-L6-L6-P
L	10	8	10	PN 500	8	6	44	22	15	15	15	17	6.7	0734112000	24-T-L10-L8-L10-P
L	10	10	6	PN 500	4	8	44	22	15	15	15	17	6.5	0733542000	24-T-L10-L10-L6-P
L	10	12	10	PN 400	8	10	48	24	17	17	17	19	8.9	0799522000	24-T-L10-L12-L10-P
L	10	15	10	PN 400	8	11	56	28	21	21	21	19	10.5	0799462000	24-T-L10-L15-L10
L	12	6	12	PN 400	10	4	48	24	17	17	17	19	9.4	0734182000	24-T-L12-L6-L12-P
L	12	8	12	PN 400	10	6	48	24	17	17	17	19	9.3	0734172000	24-T-L12-L8-L12-P
L	12	8	8	PN 400	6	6	48	24	17	17	17	19	9.3	0799932000	24-T-L12-L8-L8-P
L	12	10	10	PN 400	8	8	48	24	17	17	17	19	9.2	0797322000	24-T-L12-L10-L10-P
L	12	10	12	PN 400	10	8	48	24	17	17	17	19	9.0	0734162000	24-T-L12-L10-L12-P
L	12	12	10	PN 400	8	10	48	24	17	17	17	19	9.1	0799552000	24-T-L12-L12-L10-P
L	12	12	8	PN 400	6	10	48	24	17	17	17	19	9.2	0799542000	24-T-L12-L12-L8-P
L	12	15	12	PN 400	10	12	56	28	21	21	21	19	9.9	0799472000	24-T-L12-L15-L12
L	12	18	12	PN 400	10	15	62	31	24	24	23.5	24	15.5	0799382000	24-T-L12-L18-L12
L	12	22	12	PN 250	10	19	70	35	28	28	27.5	27	23.5	0796532000	24-T-L12-L22-L12
L	15	6	15	PN 400	12	4	56	28	21	21	21	19	10.2	0734242000	24-T-L15-L6-L15
L	15	8	15	PN 400	12	6	56	28	21	21	21	19	10.2	0734232000	24-T-L15-L8-L15
L	15	10	10	PN 400	8	8	56	28	21	21	21	19	9.9	0799492000	24-T-L15-L10-L10
L	15	10	15	PN 400	12	8	56	28	21	21	21	19	9.8	0734222000	24-T-L15-L10-L15
L	15	12	12	PN 400	10	10	56	28	21	21	21	19	9.9	0797612000	24-T-L15-L12-L12
L	15	12	15	PN 400	12	10	56	28	21	21	21	19	9.9	0734212000	24-T-L15-L12-L15
L	15	15	10	PN 400	8	12	56	28	21	21	21	19	10.0	0799942000	24-T-L15-L15-L10
L	15	15	12	PN 400	10	12	56	28	21	21	21	19	9.9	0797732000	24-T-L15-L15-L12
L	15	18	15	PN 400	12	15	62	31	24	24	24	24	19.3	0799952000	24-T-L15-L18-L15

T reducing couplings

Three sided tube connection according to
DIN 2353 / ISO 8434-1

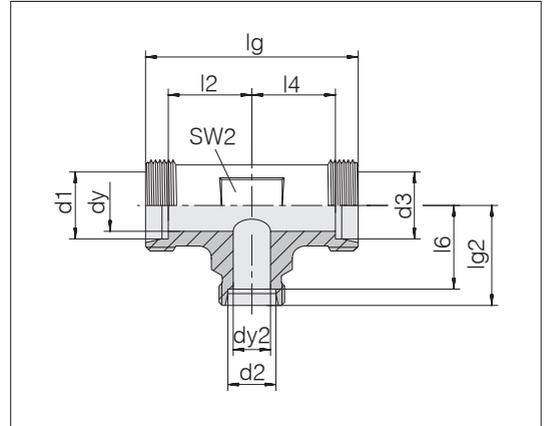

Series	d2	d3	Pressure	dy	dy2	lg	lg2	l2	l4	l6	SW2	kg/100 ca.	Order-No.	Designation
Tube OD d1														
L 15	22	15	PN 250	12	19	70	35	28	28	27.5	27	22.6	0799972000	24-T-L15-L22-L15
L 18	8	18	PN 400	15	6	62	31	23.5	23.5	24	24	19.0	0734292000	24-T-L18-L8-L18
L 18	10	10	PN 400	8	8	62	31	23.5	23.5	24	24	15.2	0799402000	24-T-L18-L10-L10
L 18	10	18	PN 400	15	8	62	31	23.5	23.5	24	24	15.4	0734282000	24-T-L18-L10-L18
L 18	12	18	PN 400	15	10	62	31	23.5	23.5	24	24	15.1	0734272000	24-T-L18-L12-L18
L 18	15	15	PN 400	12	12	62	31	23.5	23.5	24	24	18.9	0799412000	24-T-L18-L15-L15
L 18	15	18	PN 400	15	12	62	31	23.5	23.5	24	24	15.4	0734262000	24-T-L18-L15-L18
L 18	18	10	PN 400	8	15	62	31	23.5	23.5	23.5	24	15.1	0799422000	24-T-L18-L18-L10
L 18	18	15	PN 400	12	15	62	31	23.5	23.5	23.5	24	18.9	0799442000	24-T-L18-L18-L15
L 18	22	15	PN 250	12	19	70	35	27.5	27.5	27.5	27	23.3	0799742000	24-T-L18-L22-L15
L 18	22	18	PN 250	15	19	70	35	27.5	27.5	27.5	27	22.2	0799962000	24-T-L18-L22-L18
L 22	10	22	PN 250	19	8	70	35	27.5	27.5	28	27	20.4	0734342000	24-T-L22-L10-L22
L 22	12	22	PN 250	19	10	70	35	27.5	27.5	28	27	19.7	0734332000	24-T-L22-L12-L22
L 22	15	15	PN 250	12	12	70	35	28	27.5	28	27	21.2	0799362000	24-T-L22-L15-L15
L 22	15	22	PN 250	19	12	70	35	27.5	27.5	28	27	19.9	0734322000	24-T-L22-L15-L22
L 22	18	18	PN 250	15	15	70	35	27.5	27.5	27.5	27	21.2	0733562000	24-T-L22-L18-L18
L 22	18	22	PN 250	19	15	70	35	27.5	27.5	27.5	27	20.5	0734312000	24-T-L22-L18-L22
L 22	22	18	PN 250	15	19	70	35	27.5	27.5	27.5	27	19.8	0733652000	24-T-L22-L22-L18
L 22	28	22	PN 250	19	24	76	38	30.5	30.5	30.5	36	36.4	0796512000	24-T-L22-L28-L22
L 28	10	28	PN 250	24	8	76	38	30.5	30.5	31	36	31.8	0799312000	24-T-L28-L10-L28
L 28	12	28	PN 250	24	10	76	38	30.5	30.5	31	36	32.1	0734392000	24-T-L28-L12-L28
L 28	15	28	PN 250	24	12	76	38	30.5	30.5	31	36	32.3	0734382000	24-T-L28-L15-L28
L 28	18	28	PN 250	24	15	76	38	30.5	30.5	30.5	36	31.7	0734372000	24-T-L28-L18-L28
L 28	22	22	PN 250	19	19	76	38	30.5	30.5	30.5	36	32.3	0796352000	24-T-L28-L22-L22
L 28	22	28	PN 250	24	19	76	38	30.5	30.5	30.5	36	30.0	0734362000	24-T-L28-L22-L28
L 28	35	28	PN 250	24	30	90	45	37.5	37.5	34.5	41	61.8	1734082000	24-T-L28-L35-L28
L 28	42	28	PN 250	24	36	102	51	43.5	43.5	40	50	112.0	1734102000	24-T-L28-L42-L28
L 35	18	35	PN 250	30	15	90	45	34.5	34.5	37.5	41	60.0	0734432000	24-T-L35-L18-L35
L 35	28	28	PN 250	24	24	90	45	34.5	37.5	37.5	41	59.0	1734042000	24-T-L35-L28-L28
L 35	28	35	PN 250	30	24	90	45	34.5	34.5	37.5	41	54.0	0734412000	24-T-L35-L28-L35
L 35	42	35	PN 250	30	36	102	51	40.5	40.5	40	50	106.0	1734092000	24-T-L35-L42-L35

Continued on following page



T reducing couplings

Three sided tube connection according to
DIN 2353 / ISO 8434-1

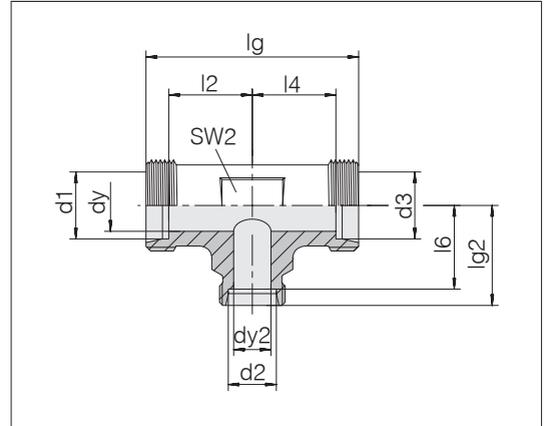

Series	d2	d3	Pressure	dy	dy2	lg	lg2	l2	l4	l6	SW2	kg/100 ca.	Order-No.	Designation	
L	42	18	42	PN 250	36	15	102	51	40	40	43.5	50	92.2	0734492000	24-T-L42-L18-L42
L	42	22	42	PN 250	36	19	102	51	40	40	43.5	50	101.6	0734482000	24-T-L42-L22-L42
L	42	28	42	PN 250	36	24	102	51	40	40	43.5	50	97.4	0734472000	24-T-L42-L28-L42
S	10	6	10	PN 800	7	4	50	25	17.5	17.5	18	19	11.7	0734622000	24-T-S10-S6-S10-P
S	12	8	12	PN 630	8	5	58	29	21.5	21.5	22	22	17.5	0734672000	24-T-S12-S8-S12-P
S	12	8	8	PN 630	5	5	58	29	21.5	21.5	22	22	16.9	0799302000	24-T-S12-S8-S8-P
S	12	10	12	PN 630	8	7	58	29	21.5	21.5	21.5	22	17.6	0734662000	24-T-S12-S10-S12-P
S	12	16	12	PN 630	8	12	66	33	24.5	24.5	24.5	24	17.7	0797822000	24-T-S12-S16-S12
S	16	6	16	PN 630	12	4	66	33	24.5	24.5	26	24	16.8	0799292000	24-T-S16-S6-S16
S	16	8	16	PN 630	12	5	66	33	24.5	24.5	26	24	17.1	0734792000	24-T-S16-S8-S16
S	16	10	16	PN 630	12	7	66	33	24.5	24.5	25.5	24	17.1	0734782000	24-T-S16-S10-S16
S	16	12	16	PN 630	12	8	66	33	24.5	24.5	25.5	24	16.9	0734772000	24-T-S16-S12-S16
S	16	20	16	PN 420	12	16	74	37	28.5	28.5	26.5	27	26.7	0799222000	24-T-S16-S20-S16
S	20	10	20	PN 420	16	7	74	37	26.5	26.5	29.5	27	26.4	0734842000	24-T-S20-S10-S20
S	20	12	20	PN 420	16	8	74	37	26.5	26.5	29.5	27	26.5	0734832000	24-T-S20-S12-S20
S	20	16	16	PN 420	12	12	74	37	26.5	28.5	28.5	27	25.3	0795972000	24-T-S20-S16-S16
S	20	16	20	PN 420	16	12	74	37	26.5	26.5	28.5	27	25.9	0734812000	24-T-S20-S16-S20
S	20	25	20	PN 420	16	20	84	42	31.5	31.5	30	36	45.3	0797452000	24-T-S20-S25-S20
S	25	12	25	PN 420	20	8	84	42	30	30	34.5	36	44.8	0734892000	24-T-S25-S12-S25
S	25	16	25	PN 420	20	12	84	42	30	30	33.5	36	44.5	0734872000	24-T-S25-S16-S25
S	25	18	25	PN 420	20	15	84	42	30	30	34.5	36	46.6	1796912000	24-T-S25-L18-S25
S	25	20	25	PN 420	20	16	84	42	30	30	31.5	36	43.4	0734862000	24-T-S25-S20-S25
S	25	25	20	PN 420	16	20	84	42	30	31.5	30	36	47.4	0733572000	24-T-S25-S25-S20
S	25	30	25	PN 420	20	25	98	49	37	37	35.5	41	77.8	0733982000	24-T-S25-S30-S25
S	30	16	30	PN 420	25	12	98	49	35.5	35.5	40.5	41	79.0	0734932000	24-T-S30-S16-S30
S	30	20	30	PN 420	25	16	98	49	35.5	35.5	38.5	41	71.0	0734922000	24-T-S30-S20-S30
S	38	16	38	PN 420	32	12	114	57	41	41	48.5	50	120.4	0734992000	24-T-S38-S16-S38
S	38	25	38	PN 420	32	20	114	57	41	41	45	50	118.3	0734972000	24-T-S38-S25-S38
S	38	38	25	PN 420	20	32	114	57	41	45	41	50	134.1	0733482000	24-T-S38-S38-S25

Cross couplings

Four sided tube connection according to
DIN 2353 / ISO 8434-1

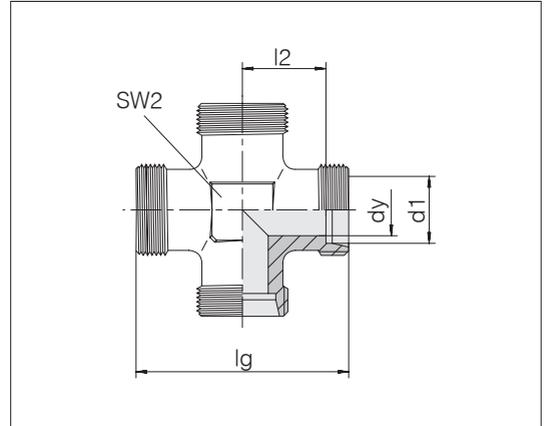

Series	Tube OD	Pressure	dy	lg	l2	SW2	kg/100 ca.	Order-No.	Designation
LL	4	PN 100	3	30	11	12	2.1	0735002000	24-K-LL4
LL	6	PN 100	4.5	30	9.5	12	2.3	0735102000	24-K-LL6
LL	8	PN 100	6	34	11.5	12	2.7	0735152000	24-K-LL8
L	6	PN 315	4	38	12	12	3.9	0736002000	24-K-L6
L	8	PN 315	6	42	14	12	4.6	0736052000	24-K-L8
L	10	PN 315	8	44	15	14	5.2	0736102000	24-K-L10
L	12	PN 315	10	48	17	17	8.2	0736152000	24-K-L12
L	15	PN 315	12	56	21	19	12.7	0736202000	24-K-L15
L	18	PN 315	15	62	23.5	24	18.8	0736252000	24-K-L18
L	22	PN 160	19	70	27.5	27	21.0	0736302000	24-K-L22
L	28	PN 160	24	76	30.5	36	34.6	0736352000	24-K-L28
L	35	PN 160	30	90	34.5	41	62.3	0736402000	24-K-L35
L	42	PN 160	36	102	40	50	94.5	0736452000	24-K-L42
S	6	PN 630	4	46	16	12	6.6	0736502000	24-K-S6
S	8	PN 630	5	48	17	14	8.1	0736552000	24-K-S8
S	10	PN 630	7	50	17.5	17	10.7	0736602000	24-K-S10
S	12	PN 630	8	58	21.5	17	14.9	0736652000	24-K-S12
S	14	PN 630	10	60	22	19	15.8	0736702000	24-K-S14
S	16	PN 400	12	66	24.5	24	23.3	0736752000	24-K-S16
S	20	PN 400	16	74	26.5	27	29.4	0736802000	24-K-S20
S	25	PN 400	20	84	30	36	51.9	0736852000	24-K-S25
S	30	PN 400	25	98	35.5	41	89.0	0736902000	24-K-S30
S	38	PN 315	32	114	41	50	140.3	0736952000	24-K-S38

Example for comp. :
K06LX
ISO 8434-1-K-L6-St

Bulkhead couplings

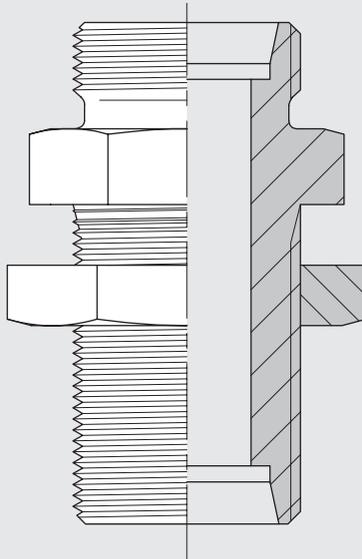

Straight bulkhead couplings

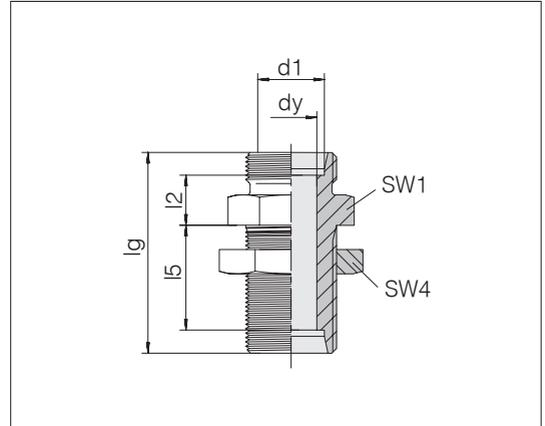

Series	Tube OD	Pressure	dy	lg	l2	l5	SW1	SW4	kg/100 ca.	Order-No.	Designation
L	6	PN 500	4	48	7	27	17	17	3.8	0137002066	24-BHSLN-L6
L	8	PN 500	6	49	8	27	19	19	4.9	0137052066	24-BHSLN-L8
L	10	PN 500	8	52	10	28	22	22	6.6	0137102066	24-BHSLN-L10
L	12	PN 400	10	53	10	29	24	24	7.6	0137152066	24-BHSLN-L12
L	15	PN 400	12	57	12	31	27	30	12.8	0137202066	24-BHSLN-L15
L	18	PN 400	15	61	13.5	32.5	32	36	19.9	0137252066	24-BHSLN-L18
L	22	PN 250	19	66	16.5	34.5	36	41	24.8	0137302066	24-BHSLN-L22
L	28	PN 250	24	69	18.5	35.5	41	46	33.8	0137352066	24-BHSLN-L28
L	35	PN 250	30	76	18.5	36.5	50	55	53.9	0137402066	24-BHSLN-L35
L	42	PN 250	36	77	19	36	60	65	75.6	0137452066	24-BHSLN-L42
S	6	PN 800	4	55	12	29	19	19	6.5	0137502066	24-BHSLN-S6
S	8	PN 800	5	56	13	29	22	22	8.7	0137552066	24-BHSLN-S8
S	10	PN 800	7	59	14.5	29.5	24	24	11.0	0137602066	24-BHSLN-S10
S	12	PN 630	8	60	14.5	30.5	27	27	13.9	0137652066	24-BHSLN-S12
S	14	PN 630	10	65	17	32	30	30	17.8	0137702066	24-BHSLN-S14
S	16	PN 630	12	65	16.5	31.5	32	32	19.7	0137752066	24-BHSLN-S16
S	20	PN 420	16	72	17.5	33.5	41	41	34.5	0137802066	24-BHSLN-S20
S	25	PN 420	20	79	20	35	46	46	49.2	0137852066	24-BHSLN-S25
S	30	PN 420	25	86	21.5	37.5	50	50	61.7	0137902066	24-BHSLN-S30
S	38	PN 420	32	91	22	37	65	65	108.0	0137952066	24-BHSLN-S38

Bulkhead material thickness
max. 16 mm.

Example for comp. :
SV06LOMD
ISO 8434-1-BHSLN-L6-St



Elbow bulkhead couplings

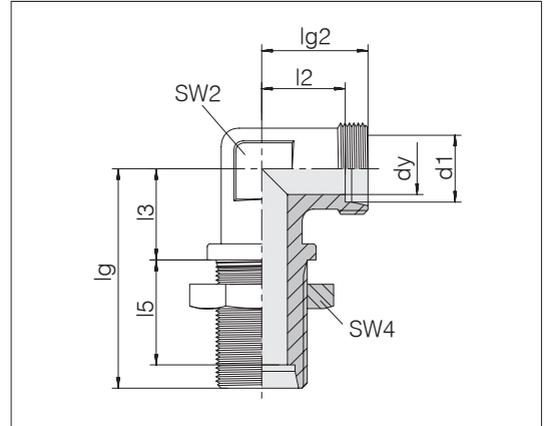

Series	Tube OD	Pressure	dy	lg	lg2	l2	l3	l5	SW2	SW4	kg/100 ca.	Order-No.	Designation
L	6	PN 315	4	48	19	12	14	27	12	17	4.9	0138002066	24-BHELN-L6
L	8	PN 315	6	51	21	14	17	27	12	19	6.1	0138052066	24-BHELN-L8
L	10	PN 315	8	53	22	15	18	28	14	22	7.9	0138102066	24-BHELN-L10
L	12	PN 315	10	56	24	17	20	29	17	24	9.6	0138152066	24-BHELN-L12
L	15	PN 315	12	61	28	21	23	31	19	30	16.9	0138202066	24-BHELN-L15
L	18	PN 315	15	64	31	23.5	24	32.5	24	36	25.5	0138252066	24-BHELN-L18
L	22	PN 160	19	72	35	27.5	30	34.5	27	41	31.8	0138302066	24-BHELN-L22
L	28	PN 160	24	77	38	30.5	34	35.5	36	46	46.2	0138352066	24-BHELN-L28
L	35	PN 160	30	86	45	34.5	39	36.5	41	55	76.9	0138402066	24-BHELN-L35
L	42	PN 160	36	90	51	40	43	36	50	65	112.3	0138452066	24-BHELN-L42
S	6	PN 630	4	53	23	16	17	29	12	19	7.6	0138502066	24-BHELN-S6
S	8	PN 630	5	54	24	17	18	29	14	22	10.2	0138552066	24-BHELN-S8
S	10	PN 630	7	57	25	17.5	20	29.5	17	24	12.4	0138602066	24-BHELN-S10
S	12	PN 630	8	59	29	21.5	21	30.5	17	27	16.0	0138652066	24-BHELN-S12
S	14	PN 630	10	63	30	22	23	32	19	30	19.6	0138702066	24-BHELN-S14
S	16	PN 400	12	64	33	24.5	24	31.5	24	32	23.8	0138752066	24-BHELN-S16
S	20	PN 400	16	74	37	26.5	30	33.5	27	41	39.9	0138802066	24-BHELN-S20
S	25	PN 400	20	81	42	30	34	35	36	46	60.9	0138852066	24-BHELN-S25
S	30	PN 400	25	90	49	35.5	39	37.5	41	50	93.2	0138902066	24-BHELN-S30
S	38	PN 315	32	96	57	41	43	37	50	65	144.9	0138952066	24-BHELN-S38

Bulkhead material thickness
max. 16 mm.

Example for comp. :
WSV06LOMD
ISO 8434-1-BHELN-L6-St

Banjo and rotary couplings

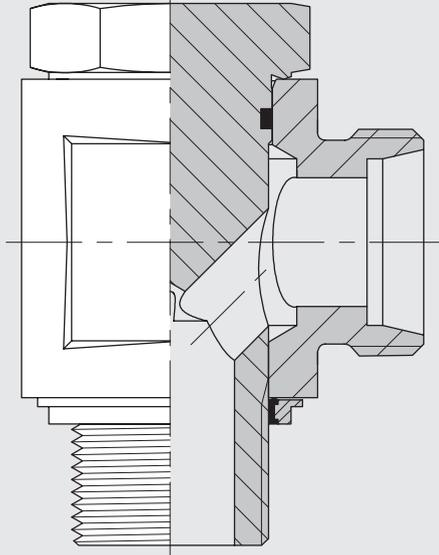

Banjo couplings

Standard design

Male thread: metric fine thread, parallel

With metal sealing-edge ring for recesses

DIN 3852 / ISO 9974

d4 narrow

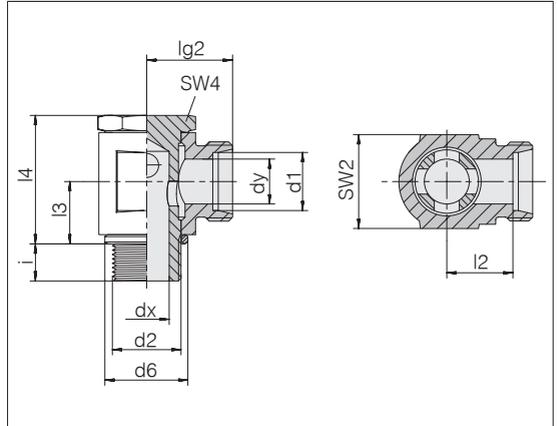

Series	d2	Pressure	d6	dx	dy	lg	l2	l3	l4	SW2	SW4	i	Nm -10 %	kg/100 ca.	Order-No.	Designation		
Tube OD d1																		
LL	4	M 8 x 1	PB 100	12	3	3	14.5	10.5	8	18.5	12	12	6	10	2.0	1150002081	24-BSE-LL4-M8B	•
LL	6	M 10 x 1	PB 100	14	4	4.5	15.5	10	9	20.5	14	14	6	15	2.7	1150102081	24-BSE-LL6-M10B	•
LL	8	M 10 x 1	PB 100	14	4.5	6	16.5	11	10	22.5	14	14	6	15	3.1	1150152081	24-BSE-LL8-M10B	•
L	6	M 10 x 1	PB 250	14	4	4	17.5	10.5	10	23.5	14	14	6	20	3.6	1151002081	24-BSE-L6-M10B	•
L	8	M 12 x 1.5	PB 250	17	5.8	6	20	13	12	27	17	17	9	30	5.5	1151052081	24-BSE-L8-M12B	•
L	10	M 14 x 1.5	PB 250	19	6.5	8	21	14	13	28	19	19	9	45	6.8	1151102081	24-BSE-L10-M14B	•
L	12	M 16 x 1.5	PB 250	21	8.5	10	22.5	15.5	15	33	22	22	9	65	10.1	1151152081	24-BSE-L12-M16B	•
L	12	M 18 x 1.5	PB 250	23	10.5	10	23.5	16.5	18.5	38	24	24	9	90	13.0	1151172081	24-BSE-L12-M18B	•
L	15	M 18 x 1.5	PB 250	23	10.5	12	24.5	17.5	18.5	38	24	24	9	90	13.4	1151202081	24-BSE-L15-M18B	•
L	18	M 22 x 1.5	PB 160	27	13	15	27.5	20	22	44	30	27	11	100	21.1	1151252081	24-BSE-L18-M22B	•
L	22	M 26 x 1.5	PB 160	31	17	19	32.5	25	24.5	48	36	32	13	150	31.3	1151302081	24-BSE-L22-M26B	•
S	6	M 12 x 1.5	PB 250	17	4	4	21	14	12	27	17	17	9	30	6.0	1151502081	24-BSE-S6-M12B	•
S	8	M 14 x 1.5	PB 250	19	5	5	22	15	13	28	19	19	9	45	7.7	1151552081	24-BSE-S8-M14B	•
S	10	M 16 x 1.5	PB 250	21	7	7	23.5	16	15	33	22	22	9	70	11.2	1151602081	24-BSE-S10-M16B	•
S	12	M 18 x 1.5	PB 250	23	8	8	24.5	17	16.5	35	24	24	9	90	14.0	1151652081	24-BSE-S12-M18B	•
S	14	M 18 x 1.5	PB 250	23	8	10	28	20	18.5	38	27	24	9	90	18.5	1151712081	24-BSE-S14-M18B	•
S	14	M 20 x 1.5	PB 250	25	10	10	28	20	18.5	39	27	27	11	110	18.6	1151702081	24-BSE-S14-M20B	•
S	16	M 22 x 1.5	PB 160	27	11	12	29.5	21	20.5	42	30	27	11	100	21.9	1151752081	24-BSE-S16-M22B	•
S	20	M 27 x 2	PB 160	32	16	16	34.5	24	23.5	48	36	32	13	150	35.1	1151802081	24-BSE-S20-M27B	•

• Standard size

Example for comp. :
SWVE06LMOMD



Banjo couplings

Standard design

Male thread: metric fine thread, parallel

With soft seal for recesses

DIN 3852 / ISO 9974

d4 narrow

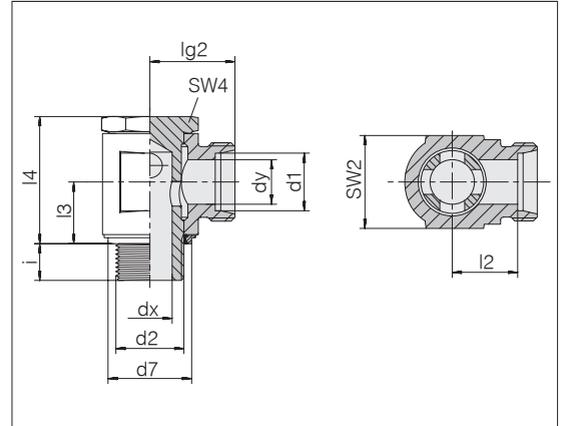

Series	d2	Pressure	d7	dx	dy	lg	l2	l3	l4	SW2	SW4	i	Nm -10 %	kg/100 ca.	Order-No.	Designation	
LL	6 M 10 x 1	PB 100	14.9	4	4.5	15.5	10	9	20.5	14	14	6	15	2.7	1150112081	24-BSE-LL6-M10E	•
LL	8 M 10 x 1	PB 100	14.9	4.5	6	16.5	11	10	22.5	14	14	6	15	3.1	1150162081	24-BSE-LL8-M10E	•
L	6 M 10 x 1	PB 250	14.9	4	4	17.5	10.5	10	23.5	14	14	6	20	3.6	1151012081	24-BSE-L6-M10E	•
L	8 M 12 x 1.5	PB 250	17	5.8	6	20	13	12	27	17	17	9	30	5.5	1151072081	24-BSE-L8-M12E	•
L	10 M 14 x 1.5	PB 250	18.9	6.5	8	21	14	13	28	19	19	9	45	6.8	1151112081	24-BSE-L10-M14E	•
L	12 M 16 x 1.5	PB 250	21.9	8.5	10	22.5	15.5	15	33	22	22	9	65	10.1	1151162081	24-BSE-L12-M16E	•
L	12 M 18 x 1.5	PB 250	23.9	10.5	10	23.5	16.5	18.5	38	24	24	9	90	13.0	1151182081	24-BSE-L12-M18E	•
L	15 M 18 x 1.5	PB 250	23.9	10.5	12	24.5	17.5	18.5	38	24	24	9	90	13.4	1151212081	24-BSE-L15-M18E	•
L	18 M 22 x 1.5	PB 160	26.9	13	15	27.5	20	22	44	30	27	11	100	21.1	1151262081	24-BSE-L18-M22E	•
L	22 M 26 x 1.5	PB 160	31.9	17	19	32.5	25	24.5	48	36	32	13	150	31.3	1151312081	24-BSE-L22-M26E	•
S	6 M 12 x 1.5	PB 250	17	4	4	21	14	12	27	17	17	9	30	6.0	1151512081	24-BSE-S6-M12E	•
S	8 M 14 x 1.5	PB 250	18.9	5	5	22	15	13	28	19	19	9	45	7.7	1151562081	24-BSE-S8-M14E	•
S	10 M 16 x 1.5	PB 250	21.9	7	7	23.5	16	15	33	22	22	9	70	11.2	1151612081	24-BSE-S10-M16E	•
S	12 M 18 x 1.5	PB 250	23.9	8	8	24.5	17	16.5	35	24	24	9	90	14.0	1151662081	24-BSE-S12-M18E	•
S	16 M 22 x 1.5	PB 160	26.9	11	12	29.5	21	20.5	42	30	27	11	100	21.9	1151762081	24-BSE-S16-M22E	•
S	20 M 27 x 2	PB 160	32.9	16	16	34.5	24	23.5	48	36	32	13	150	35.1	1151812081	24-BSE-S20-M27E	•

• Standard size

Example for comp. :
SWVE06LMKDSOMD

Banjo couplings

Standard design

Male thread: Whitworth pipe thread, parallel

With metal sealing-edge ring for recesses

DIN 3852 / ISO 1179

d4 narrow

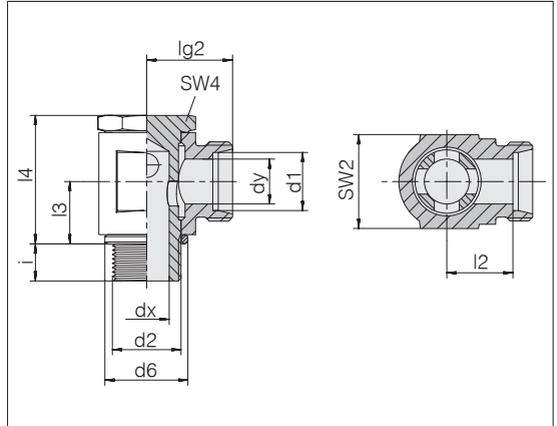

Series	d2	Pressure	d6	dx	dy	lg2	l2	l3	l4	SW2	SW4	i	Nm -10 %	kg/100 ca.	Order-No.	Designation		
Tube OD d1																		
LL	4	G 1/8 A	PB 100	14	3	3	15.5	11.5	8	18.5	14	14	6	15	2.5	1152002081	24-BSE-LL4-G1/8B	•
LL	6	G 1/8 A	PB 100	14	4	4.5	15.5	10	9	20.5	14	14	6	15	2.7	1152102081	24-BSE-LL6-G1/8B	•
LL	8	G 1/8 A	PB 100	14	4.5	6	16.5	11	10	22.5	14	14	6	15	3.1	1152152081	24-BSE-LL8-G1/8B	•
L	6	G 1/8 A	PB 250	14	4	4	17.5	10.5	10	23.5	14	14	6	20	3.5	1153002081	24-BSE-L6-G1/8B	•
L	6	G 1/4 A	PB 250	18	5.8	4	20	13	12	27	19	19	9	45	6.5	1153012081	24-BSE-L6-G1/4B	•
L	8	G 1/4 A	PB 250	18	5.8	6	20	13	12	27	19	19	9	45	6.5	1153052081	24-BSE-L8-G1/4B	•
L	10	G 1/4 A	PB 250	18	6.5	8	21	14	13	28	19	19	9	50	6.8	1153102081	24-BSE-L10-G1/4B	•
L	12	G 3/8 A	PB 250	22	8.5	10	22.5	15.5	15.5	33	22	22	9	75	10.3	1153152081	24-BSE-L12-G3/8B	•
L	12	G 1/2 A	PB 250	26	10.5	10	25	18	19	38	27	27	11	110	16.8	1153172081	24-BSE-L12-G1/2B	•
L	15	G 3/8 A	PB 250	22	9	12	24.5	17.5	18.5	38	24	24	9	75	14.4	1152982081	24-BSE-L15-G3/8B	•
L	15	G 1/2 A	PB 250	26	10.5	12	26	19	19	38	27	27	11	110	17.6	1153202081	24-BSE-L15-G1/2B	•
L	18	G 1/2 A	PB 160	26	13	15	27.5	20	22	44	30	27	11	100	20.2	1153252081	24-BSE-L18-G1/2B	•
L	22	G 3/4 A	PB 160	32	17	19	32.5	25	24	48	36	32	13	150	31.8	1153302081	24-BSE-L22-G3/4B	•
S	6	G 1/4 A	PB 250	18	4	4	22	15	12	27	19	19	9	45	7.3	1153502081	24-BSE-S6-G1/4B	•
S	8	G 1/4 A	PB 250	18	5	5	22	15	13	28	19	19	9	50	7.4	1153552081	24-BSE-S8-G1/4B	•
S	10	G 3/8 A	PB 250	22	7	7	23.5	16	15.5	33	22	22	9	70	11.1	1153602081	24-BSE-S10-G3/8B	•
S	12	G 3/8 A	PB 250	22	8	8	23.5	16	16.5	36	24	22	9	70	14.0	1153652081	24-BSE-S12-G3/8B	•
S	14	G 1/2 A	PB 250	26	10	10	28	20	19	38.5	27	27	11	115	18.4	1153702081	24-BSE-S14-G1/2B	•
S	16	G 1/2 A	PB 160	26	11	12	29.5	21	20.5	42	30	27	11	100	22.0	1153752081	24-BSE-S16-G1/2B	•
S	20	G 3/4 A	PB 160	32	16	16	34.5	24	24	48	36	32	13	150	34.6	1153802081	24-BSE-S20-G3/4B	•

• Standard size

Example for comp. :
SWVE06LROMD



Banjo couplings

Standard design

Male thread: Whitworth pipe thread, parallel

With soft seal for recesses

DIN 3852 / ISO 1179

d4 narrow

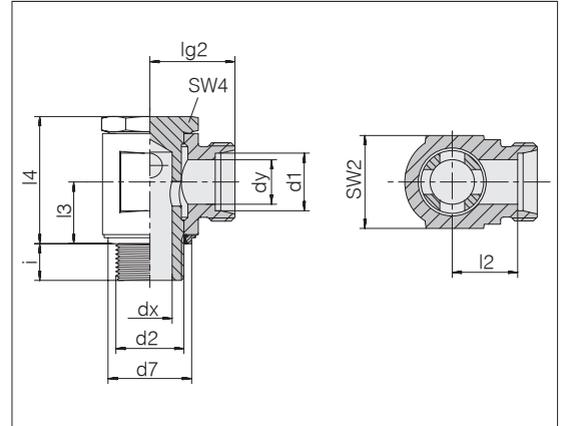

Series	d2	Pressure	d7	dx	dy	lg2	l2	l3	l4	SW2	SW4	i	Nm -10 %	kg/100 ca.	Order-No.	Designation		
LL	4	G 1/8 A	PB 100	14.9	3	3	15.5	11.5	8	18.5	14	14	6	15	2.5	1152012081	24-BSE-LL4-G1/8E	•
LL	6	G 1/8 A	PB 100	14.9	4	4.5	15.5	10	9	20.5	14	14	6	15	2.7	1152112081	24-BSE-LL6-G1/8E	•
LL	8	G 1/8 A	PB 100	14.9	4.5	6	16.5	11	10	22.5	14	14	6	15	3.1	1152162081	24-BSE-LL8-G1/8E	•
L	6	G 1/8 A	PB 250	14.9	4	4	17.5	10.5	10	23.5	14	14	6	20	3.5	1153022081	24-BSE-L6-G1/8E	•
L	6	G 1/4 A	PB 250	18.9	5.8	4	20	13	12	27	19	19	9	45	6.5	1153032081	24-BSE-L6-G1/4E	•
L	8	G 1/4 A	PB 250	18.9	5.8	6	20	13	12	27	19	19	9	45	6.5	1153062081	24-BSE-L8-G1/4E	•
L	10	G 1/4 A	PB 250	18.9	6.5	8	21	14	13	28	19	19	9	50	6.8	1153122081	24-BSE-L10-G1/4E	•
L	10	G 3/8 A	PB 250	21.9	8.5	8	22.5	15.5	15.5	33	22	22	9	75	10.4	1153132081	24-BSE-L10-G3/8E	•
L	12	G 1/4 A	PB 250	18.9	6.5	10	22.5	15.5	15.5	32	22	19	9	50	9.5	1153972081	24-BSE-L12-G1/4E	•
L	12	G 3/8 A	PB 250	21.9	8.5	10	22.5	15.5	15.5	33	22	22	9	75	10.3	1153992081	24-BSE-L12-G3/8E	•
L	12	G 1/2 A	PB 250	26.9	10.5	10	25	18	19	38	27	27	11	110	16.8	1153982081	24-BSE-L12-G1/2E	•
L	15	G 3/8 A	PB 250	21.9	9	12	24.5	17.5	18.5	38	24	24	9	75	14.7	1152992081	24-BSE-L15-G3/8E	•
L	15	G 1/2 A	PB 250	26.9	10.5	12	26	19	19	38	27	27	11	110	17.6	1153212081	24-BSE-L15-G1/2E	•
L	18	G 1/2 A	PB 160	26.9	13	15	27.5	20	22	44	30	27	11	100	20.2	1153262081	24-BSE-L18-G1/2E	•
L	22	G 3/4 A	PB 160	39.9	17	19	32.5	25	24	48	36	32	13	150	31.8	1153312081	24-BSE-L22-G3/4E	•
S	6	G 1/4 A	PB 250	18.9	4	4	22	15	12	27	19	19	9	45	7.3	1153512081	24-BSE-S6-G1/4E	•
S	8	G 1/4 A	PB 250	18.9	5	5	22	15	13	28	19	19	9	50	7.4	1153562081	24-BSE-S8-G1/4E	•
S	10	G 3/8 A	PB 250	21.9	7	7	23.5	16	15.5	33	22	22	9	70	11.1	1153612081	24-BSE-S10-G3/8E	•
S	12	G 3/8 A	PB 250	21.9	8	8	23.5	16	16.5	36	24	22	9	70	14.0	1153662081	24-BSE-S12-G3/8E	•
S	14	G 1/2 A	PB 250	26.9	10	10	28	20	19	38.5	27	27	11	115	18.4	1153712081	24-BSE-S14-G1/2E	•
S	16	G 1/2 A	PB 160	26.9	11	12	29.5	21	20.5	42	30	27	11	100	22.0	1153762081	24-BSE-S16-G1/2E	•
S	20	G 3/4 A	PB 160	32.9	16	16	34.5	24	24	48	36	32	13	150	34.6	1153812081	24-BSE-S20-G3/4E	•

• Standard size

Example for comp. :
SWVE06LRKDSOMD

Banjo couplings

Unrestricted flow design with eccentric flow channel

Male thread: metric fine thread, parallel

With sealing-edge ring for recesses

DIN 3852 / ISO 9974

d4 narrow

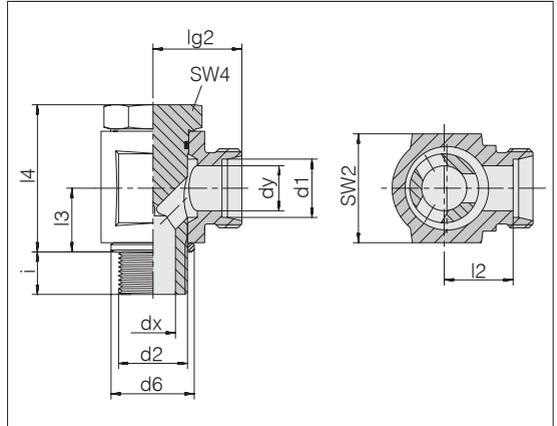

Series	d2	Pressure	d6	dx	dy	lg2	l2	l3	l4	SW2	SW4	i	Nm -10 %	kg/100 ca.	Order-No.	Designation		
Tube OD d1																		
L 6	M 10 x 1	PB 500	14	4	4	19	12	10.5	25.3	19	14	8	30	5.1	1155002081	24-BEE-L6-M10B	•	
L 8	M 12 x 1.5	PB 400	17	6	6	21.5	14.5	14	31.5	22	17	12	42	9.5	1155052081	24-BEE-L8-M12B	•	
L 10	M 14 x 1.5	PB 350	19	8	8	22.5	15.5	14	33	22	19	12	42	9.9	1155102081	24-BEE-L10-M14B	•	
L 10	M 18 x 1.5	PB 315	23	12	8	22.5	20	18.5	42.5	30	24	12	70	20.6	1154952081	24-BEE-L10-M18B	•	
L 12	M 16 x 1.5	PB 350	21	10	10	25	18	16.5	38.5	27	22	12	60	16.3	1155152081	24-BEE-L12-M16B	•	
L 12	M 18 x 1.5	PB 315	23	12	10	27	20	18.5	42.5	30	24	12	70	20.7	1155172081	24-BEE-L12-M18B	•	
L 15	M 18 x 1.5	PB 315	23	12	12	28	21	18.5	42.5	30	24	12	70	21.6	1155202081	24-BEE-L15-M18B	•	
L 15	M 22 x 1.5	PB 315	27	15	12	29	22	21.5	47.5	36	27	14	160	29.8	1155222081	24-BEE-L15-M22B	•	
L 18	M 22 x 1.5	PB 315	27	15	15	29	21.5	21.5	47.5	36	27	14	160	29.8	1155252081	24-BEE-L18-M22B	•	
L 22	M 26 x 1.5	PB 200	31	19	19	33.5	26	24	55.5	41	32	16	140	46.4	1155302081	24-BEE-L22-M26B	•	
L 28	M 33 x 2	PB 200	39	24	24	39	31.5	30.5	68	50	41	18	350	88.3	1155352081	24-BEE-L28-M33B	•	
L 35	M 42 x 2	PB 200	49	30	30	46	35.5	35.5	78	60	50	20	500	145.6	1155402081	24-BEE-L35-M42B	•	
L 42	M 48 x 2	PB 200	55	36	36	51	40	40.5	88.5	70	60	22	600	215.4	1155452081	24-BEE-L42-M48B	•	
S 6	M 12 x 1.5	PB 500	17	4	4	23.5	16.5	14	30.5	22	17	12	57	9.9	1155502081	24-BEE-S6-M12B	•	
S 8	M 14 x 1.5	PB 450	19	5	5	23.5	16.5	14	31	22	19	12	90	10.9	1155552081	24-BEE-S8-M14B	•	
S 10	M 16 x 1.5	PB 400	21	7	7	26	18.5	16.5	37	27	22	12	100	17.0	1155602081	24-BEE-S10-M16B	•	
S 12	M 18 x 1.5	PB 400	23	8	8	28	20.5	18.5	40	30	24	12	130	22.9	1155652081	24-BEE-S12-M18B	•	
S 14	M 20 x 1.5	PB 400	25	10	10	31	23	20	43	32	27	14	160	28.5	1155702081	24-BEE-S14-M20B	•	
S 16	M 22 x 1.5	PB 400	27	12	12	31	22.5	21.5	47	36	27	14	180	32.0	1155752081	24-BEE-S16-M22B	•	
S 20	M 22 x 1.5	PB 400	27	12	16	38	27.5	25	55	46	27	14	180	58.5	1154942081	24-BEE-S20-M22B	•	
S 20	M 27 x 2	PB 400	32	16	16	38	27.5	24	55	46	36	16	300	59.6	1155802081	24-BEE-S20-M27B	•	
S 25	M 33 x 2	PB 250	39	20	20	43	31	30.5	66.5	50	41	18	380	94.8	1155852081	24-BEE-S25-M33B	•	
S 30	M 42 x 2	PB 250	49	25	25	50	36.5	35.5	75.5	60	50	20	600	154.0	1155902081	24-BEE-S30-M42B	•	
S 38	M 48 x 2	PB 250	55	32	32	57	41	40.5	86.5	70	60	22	750	231.7	1155952081	24-BEE-S38-M48B	•	

• Standard size

Example for comp. :
WH06LMOMD



Banjo couplings

Unrestricted flow design with eccentric flow channel

Male thread: Whitworth pipe thread, parallel

With sealing-edge ring for recesses

DIN 3852 / ISO 1179

d4 narrow

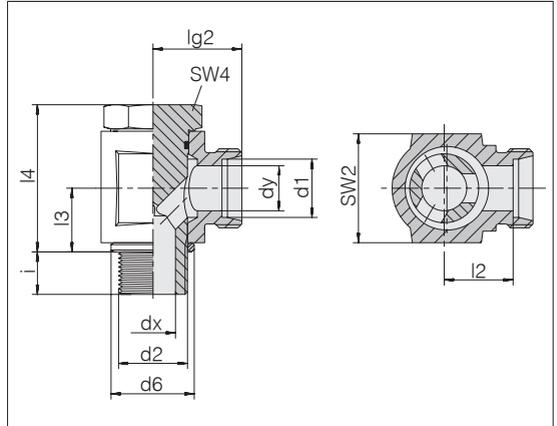

Series	d2	Pressure	d6	dx	dy	lg2	l2	l3	l4	SW2	SW4	i	Nm -10 %	kg/100 ca.	Order-No.	Designation	
Tube OD d1																	
L 6	G 1/8 A	PB 500	14	4	4	19	12	10.5	25.3	19	14	8	25	5.0	1157002081	24-BEE-L6-G1/8B	•
L 6	G 1/4 A	PB 400	18	6	4	21.5	14.5	14	29.5	22	19	12	40	9.8	1156832081	24-BEE-L6-G1/4B	•
L 8	G 1/4 A	PB 400	18	6	6	21.5	14.5	14	31.5	22	19	12	40	10.0	1157052081	24-BEE-L8-G1/4B	•
L 10	G 1/4 A	PB 350	18	8	8	22.5	15.5	14	33	22	19	12	38	10.4	1157102081	24-BEE-L10-G1/4B	•
L 12	G 3/8 A	PB 350	22	10	10	25	18	16.5	38.5	27	22	12	75	16.5	1157152081	24-BEE-L12-G3/8B	•
L 12	G 1/2 A	PB 315	26	12	10	29	22	21.5	45.5	32	27	14	110	28.4	1157192081	24-BEE-L12-G1/2B	•
L 15	G 1/2 A	PB 315	26	12	12	29	22	21.5	45.5	32	27	14	110	28.7	1157202081	24-BEE-L15-G1/2B	•
L 18	G 1/2 A	PB 315	26	15	15	29	21.5	21.5	47.5	36	27	14	110	29.3	1157252081	24-BEE-L18-G1/2B	•
L 22	G 3/4 A	PB 200	32	19	19	36	28.5	24	56.5	46	36	16	160	56.3	1157302081	24-BEE-L22-G3/4B	•
L 28	G 1 A	PB 200	39	24	24	39	31.5	30.5	68	50	41	18	270	88.1	1157352081	24-BEE-L28-G1B	•
L 35	G 1 1/4 A	PB 200	49	30	30	46	35.5	35.5	78	60	50	20	500	147.9	1157402081	24-BEE-L35-G11/4B	•
L 42	G 1 1/2 A	PB 200	55	36	36	51	40	40.5	88.5	70	60	22	600	218.6	1157452081	24-BEE-L42-G11/2B	•
S 6	G 1/4 A	PB 500	18	4	4	23.5	16.5	14	30.5	22	19	12	53	10.3	1157502081	24-BEE-S6-G1/4B	•
S 8	G 1/4 A	PB 450	18	5	5	23.5	16.5	14	31	22	19	12	53	10.6	1157552081	24-BEE-S8-G1/4B	•
S 10	G 3/8 A	PB 400	22	7	7	26	18.5	16.5	37	27	22	12	120	17.3	1157602081	24-BEE-S10-G3/8B	•
S 12	G 3/8 A	PB 400	22	8	8	26	18.5	16.5	37.5	27	22	12	120	17.8	1157652081	24-BEE-S12-G3/8B	•
S 14	G 1/2 A	PB 400	26	10	10	31	23	21.5	43	32	27	14	160	29.1	1157702081	24-BEE-S14-G1/2B	•
S 16	G 1/2 A	PB 400	26	12	12	31	22.5	21.5	47	36	27	14	160	31.5	1157752081	24-BEE-S16-G1/2B	•
S 20	G 3/4 A	PB 400	32	16	16	38	27.5	24	55	46	36	16	330	59.4	1157802081	24-BEE-S20-G3/4B	•
S 25	G 1 A	PB 250	39	20	20	43	31	30.5	66.5	50	41	18	380	93.2	1157852081	24-BEE-S25-G1B	•
S 30	G 1 1/4 A	PB 250	49	25	25	50	36.5	35.5	75.5	60	50	20	600	156.7	1157902081	24-BEE-S30-G11/4B	•
S 38	G 1 1/2 A	PB 250	55	32	32	57	41	40.5	86.5	70	60	22	800	232.3	1157952081	24-BEE-S38-G11/2B	•

• Standard size

Example for comp. :
WH06LROMD



Banjo couplings

Unrestricted flow design with eccentric flow channel

Male thread: Whitworth pipe thread, parallel

With soft seal for recesses

DIN 3852 / ISO 1179

d4 narrow

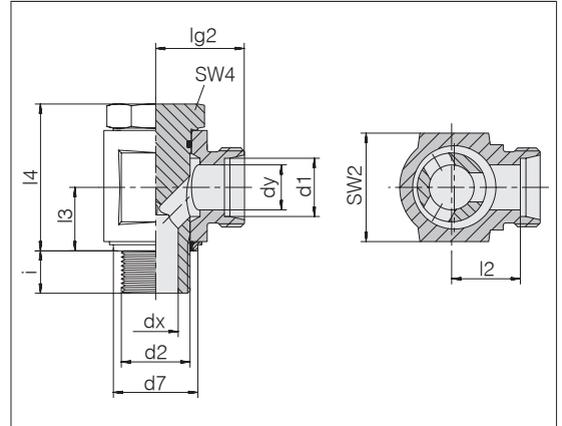

Series	d2	Pressure	d7	dx	dy	lg2	l2	l3	l4	SW2	SW4	i	Nm -10 %	kg/100 ca.	Order-No.	Designation		
Tube OD	d1																	
L	6	G 1/8 A	PB 500	14.9	4	4	19	12	10.5	25.3	19	14	8	25	5.0	1157012081	24-BEE-L6-G1/8E	•
L	6	G 1/4 A	PB 400	18.9	6	4	21.5	14.5	14	31.5	22	19	12	40	9.7	1154812081	24-BEE-L6-G1/4E	•
L	8	G 1/4 A	PB 400	18.9	6	6	21.5	14.5	14	31.5	22	19	12	40	9.8	1157062081	24-BEE-L8-G1/4E	•
L	10	G 1/4 A	PB 350	18.9	8	8	22.5	15.5	14	33	22	19	12	38	10.1	1157112081	24-BEE-L10-G1/4E	•
L	10	G 3/8 A	PB 350	21.9	10	8	22.5	18	16.5	38.5	27	22	12	75	16.4	1154732081	24-BEE-L10-G3/8E	•
L	12	G 1/4 A	PB 350	21.9	8	10	25	18	16.5	37	27	22	12	75	14.6	1154822081	24-BEE-L12-G1/4E	•
L	12	G 3/8 A	PB 350	21.9	10	10	25	18	16.5	38.5	27	22	12	75	16.2	1157162081	24-BEE-L12-G3/8E	•
L	12	G 1/2 A	PB 315	30	12	10	29	22	21.5	45.5	32	27	14	110	27.7	1156812081	24-BEE-L12-G1/2E	•
L	15	G 1/2 A	PB 315	26.9	12	12	29	22	21.5	45.5	32	27	14	110	28.4	1157212081	24-BEE-L15-G1/2E	•
L	18	G 1/2 A	PB 315	26.9	15	15	29	21.5	21.5	47.5	36	27	14	110	29.6	1157262081	24-BEE-L18-G1/2E	•
L	22	G 3/4 A	PB 200	32.9	19	19	36	28.5	24	56.5	46	36	16	160	56.8	1157312081	24-BEE-L22-G3/4E	•
L	28	G 1 A	PB 200	39.9	24	24	39	31.5	30.5	68	50	41	18	270	86.6	1157362081	24-BEE-L28-G1E	•
L	35	G 1 1/4 A	PB 200	49.9	30	30	46	35.5	35.5	78	60	50	20	500	146.6	1157412081	24-BEE-L35-G11/4E	•
L	42	G 1 1/2 A	PB 200	55.9	36	36	51	40	40.5	88.5	70	60	22	600	214.5	1157462081	24-BEE-L42-G11/2E	•
S	6	G 1/4 A	PB 500	18.9	4	4	23.5	16.5	14	30.5	22	19	12	53	10.4	1157512081	24-BEE-S6-G1/4E	•
S	8	G 1/4 A	PB 450	18.9	5	5	23.5	16.5	14	31	22	19	12	53	10.5	1157562081	24-BEE-S8-G1/4E	•
S	10	G 3/8 A	PB 400	21.9	7	7	26	18.5	16.5	37	27	22	12	120	17.3	1157612081	24-BEE-S10-G3/8E	•
S	12	G 3/8 A	PB 400	21.9	8	8	26	18.5	16.5	37.5	27	22	12	120	17.5	1157662081	24-BEE-S12-G3/8E	•
S	14	G 1/2 A	PB 400	26.9	10	10	31	23	21.5	44	32	27	14	160	29.5	1157712081	24-BEE-S14-G1/2E	•
S	16	G 1/2 A	PB 400	26.9	12	12	31	22.5	21.5	47	36	27	14	160	31.2	1157762081	24-BEE-S16-G1/2E	•
S	20	G 3/4 A	PB 400	32.9	16	16	38	27.5	24	55	46	36	16	330	59.4	1157812081	24-BEE-S20-G3/4E	•
S	25	G 1 A	PB 250	39.9	20	20	43	31	30.5	66.5	50	41	18	380	93.8	1157862081	24-BEE-S25-G1E	•
S	30	G 1 1/4 A	PB 250	49.9	25	25	50	36.5	35.5	75.5	60	50	20	600	155.2	1157912081	24-BEE-S30-G11/4E	•
S	38	G 1 1/2 A	PB 250	55.9	32	32	57	41	40.5	86.5	70	60	22	800	231.1	1157962081	24-BEE-S38-G11/2E	•

• Standard size

Example for comp. :
WH06LRKDSOMD

Banjo couplings

Compact design - **high-pressure**

Male thread: metric fine thread, parallel

With soft seal for recesses

DIN 3852 / ISO 9974

d4 narrow

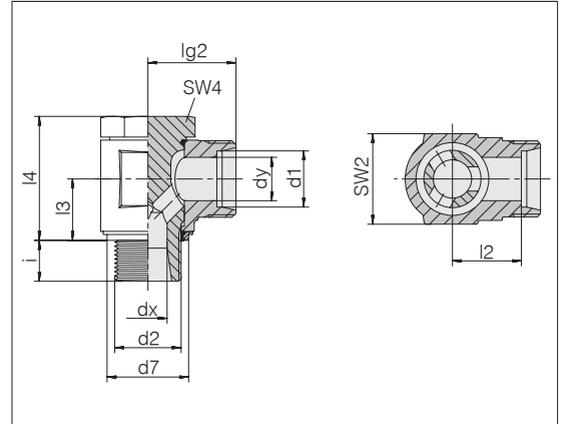

Series	d2	Pressure	d7	dx	dy	lg2	l2	l3	l4	SW2	SW4	i	Nm -10 %	kg/100 ca.	Order-No.	Designation		
L	6	M 10 x 1	PB 500	14.9	4	4	20	13	10	21	14	14	8	25	3.6	1150202081	24-BCE-L6-M10E	•
L	8	M 12 x 1.5	PB 500	17.9	5	6	21	14	13.5	27	19	19	10	50	7.5	1150212081	24-BCE-L8-M12E	•
L	10	M 14 x 1.5	PB 500	18.9	5	8	22	15	13.5	27	19	19	10	60	8.2	1150222081	24-BCE-L10-M14E	•
L	12	M 16 x 1.5	PB 400	21.9	8	10	24.5	17.5	16	32.5	24	22	10	80	12.4	1150232081	24-BCE-L12-M16E	•
L	12	M 18 x 1.5	PB 315	23.9	8	10	27	20	18.5	36	24	22	10	100	14.2	1150242081	24-BCE-L12-M18E	•
L	15	M 18 x 1.5	PB 400	23.9	9.5	12	27	20	18.5	37	27	24	10	100	19.2	1150252081	24-BCE-L15-M18E	•
L	18	M 22 x 1.5	PB 400	27.9	11	15	28	20.5	21.5	43	30	27	12	140	27.9	1150262081	24-BCE-L18-M22E	•
L	22	M 26 x 1.5	PB 250	31.9	15	19	34.5	27	24	48	36	32	16	180	42.0	1150272081	24-BCE-L22-M26E	•
L	28	M 33 x 2	PB 250	39.9	19	24	39	31.5	30.5	59	46	41	18	380	86.0	1150282081	24-BCE-L28-M33E	•
L	35	M 42 x 2	PB 250	49.9	24	30	46	35.5	35.5	70	55	50	20	500	145.7	1150292081	24-BCE-L35-M42E	•
L	42	M 48 x 2	PB 250	55.9	31	36	51	40	40.5	80	65	55	22	600	219.2	1150302081	24-BCE-L42-M48E	•
S	6	M 12 x 1.5	PB 500	17.9	5	4	23	16	13.5	27	19	19	10	50	7.9	1150312081	24-BCE-S6-M12E	•
S	8	M 14 x 1.5	PB 500	18.9	5	5	23	16	13.5	27	19	19	10	60	8.9	1150322081	24-BCE-S8-M14E	•
S	10	M 16 x 1.5	PB 500	21.9	8	7	25.5	18	16	32.5	24	22	10	80	13.1	1150332081	24-BCE-S10-M16E	•
S	12	M 18 x 1.5	PB 400	23.9	9.5	8	27	19.5	18.5	37	27	24	10	110	19.5	1150342081	24-BCE-S12-M18E	•
S	16	M 22 x 1.5	PB 400	27.9	11	12	30	21.5	21.5	43	30	27	12	140	28.2	1150362081	24-BCE-S16-M22E	•
S	20	M 27 x 2	PB 315	32.9	15	16	36.5	26	24	48	36	32	16	300	45.4	1150372081	24-BCE-S20-M27E	•
S	25	M 33 x 2	PB 250	39.9	19	20	43	31	30.5	59	46	41	18	380	85.9	1150382081	24-BCE-S25-M33E	•
S	30	M 42 x 2	PB 250	49.9	24	25	50	36.5	35.5	70	55	50	20	600	144.7	1150392081	24-BCE-S30-M42E	•
S	38	M 48 x 2	PB 250	55.9	31	32	57	41	40.5	80	65	55	22	700	232.0	1150402081	24-BCE-S38-M48E	•

• Standard size

Banjo couplings

Compact design - **high-pressure**

Male thread: Whitworth pipe thread, parallel

With metal sealing-edge ring for recesses

DIN 3852 / ISO 1179

d4 narrow

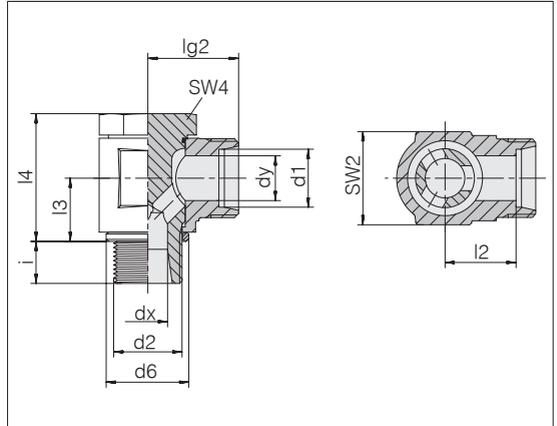

Series	d2	Pressure	d6	dx	dy	lg2	l2	l3	l4	SW2	SW4	i	Nm -10 %	kg/100 ca.	Order-No.	Designation		
Tube OD d1																		
L 6	G 1/8 A	PB 500	14	4	4	20	13	10	21	14	14	8	25	5.9	1152412081	24-BCE-L6-G1/8B	•	
L 6	G 1/4 A	PB 500	18	5	4	22	15	13.5	27	19	19	10	45	5.9	1152422081	24-BCE-L6-G1/4B		
L 8	G 1/4 A	PB 500	18	5	6	21	14	13.5	27	19	19	10	45	9.3	1152432081	24-BCE-L8-G1/4B	•	
L 10	G 1/4 A	PB 500	18	5	8	22	15	13.5	27	19	19	10	45	10.2	1152442081	24-BCE-L10-G1/4B	•	
L 12	G 1/4 A	PB 400	18	5	10	22	15	15.5	30	22	19	10	45	15.8	1152452081	24-BCE-L12-G1/4B		
L 12	G 3/8 A	PB 400	22	8	10	24.5	17.5	16	32.5	24	22	10	75	15.9	1152462081	24-BCE-L12-G3/8B	•	
L 15	G 1/2 A	PB 400	26	11	12	28	21	21.5	43	30	27	12	110	28.4	1152472081	24-BCE-L15-G1/2B	•	
L 18	G 1/2 A	PB 400	26	11	15	28	20.5	21.5	43	30	27	12	110	32.0	1152482081	24-BCE-L18-G1/2B	•	
L 22	G 3/4 A	PB 250	32	15	19	34.5	27	24	48	36	32	16	210	48.5	1152492081	24-BCE-L22-G3/4B	•	
L 28	G 1 A	PB 250	39	19	24	39	31.5	30.5	59	46	41	18	380	88.2	1152502081	24-BCE-L28-G1B	•	
L 35	G 1 1/4 A	PB 250	49	24	30	46	35.5	35.5	70	55	50	20	500	150.8	1152512081	24-BCE-L35-G11/4B	•	
L 42	G 1 1/2 A	PB 250	55	31	36	51	40	40.5	80	65	55	22	650	234.1	1152522081	24-BCE-L42-G11/2B	•	
S 6	G 1/4 A	PB 500	18	5	4	23	16	13.5	27	19	19	10	50	8.7	1152532081	24-BCE-S6-G1/4B	•	
S 8	G 1/4 A	PB 500	18	5	5	23	16	13.5	27	19	19	10	50	10.3	1152542081	24-BCE-S8-G1/4B	•	
S 10	G 3/8 A	PB 500	22	8	7	25.5	18	16	32.5	24	22	10	80	17.0	1152552081	24-BCE-S10-G3/8B	•	
S 12	G 3/8 A	PB 400	22	8	8	25.5	18	16	32.5	24	22	10	80	17.9	1152562081	24-BCE-S12-G3/8B	•	
S 14	G 1/2 A	PB 400	26	11	10	30	22	19.5	41	30	27	12	160	30.3	1152572081	24-BCE-S14-G1/2B	•	
S 16	G 1/2 A	PB 400	26	11	12	30	21.5	21.5	43	30	27	12	160	31.6	1152582081	24-BCE-S16-G1/2B	•	
S 20	G 3/4 A	PB 315	32	15	16	36.5	26	24	48	36	32	16	250	51.8	1152592081	24-BCE-S20-G3/4B	•	
S 25	G 1 A	PB 250	39	19	20	43	31	30.5	59	46	41	18	380	103.0	1152602081	24-BCE-S25-G1B	•	
S 30	G 1 1/4 A	PB 250	49	24	25	50	36.5	35.5	70	55	50	20	600	163.7	1152612081	24-BCE-S30-G11/4B	•	
S 38	G 1 1/2 A	PB 250	55	31	32	57	41	40.5	80	65	55	22	700	262.7	1152622081	24-BCE-S38-G11/2B	•	

• Standard size



Banjo couplings

Compact design - **high-pressure**

Male thread: Whitworth pipe thread, parallel

With soft seal for recesses

DIN 3852 / ISO 1179

d4 narrow

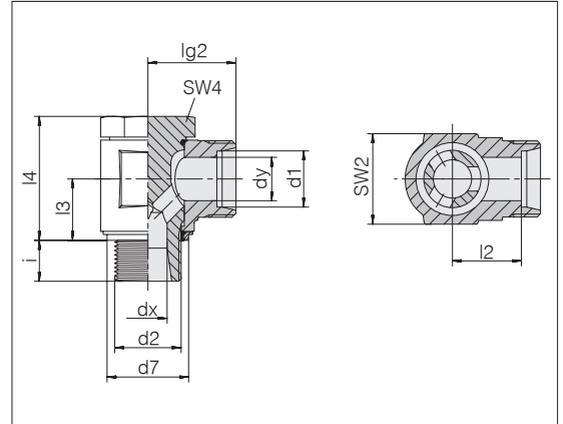

Series	d2	Pressure	d7	dx	dy	lg2	l2	l3	l4	SW2	SW4	i	Nm -10 %	kg/100 ca.	Order-No.	Designation		
L	6	G 1/8 A	PB 500	14.9	4	4	20	13	10	21	14	8	25	5.9	1150412081	24-BCE-L6-G1/8E	•	
L	6	G 1/4 A	PB 500	18.9	5	4	22	15	13.5	27	19	10	45	5.9	1150422081	24-BCE-L6-G1/4E	•	
L	8	G 1/4 A	PB 500	18.9	5	6	21	14	13.5	27	19	10	45	9.3	1150432081	24-BCE-L8-G1/4E	•	
L	10	G 1/4 A	PB 500	18.9	5	8	22	15	13.5	27	19	10	45	10.2	1150442081	24-BCE-L10-G1/4E	•	
L	12	G 1/4 A	PB 400	18.9	5	10	22	15	15.5	30	22	19	10	45	15.8	1150452081	24-BCE-L12-G1/4E	•
L	12	G 3/8 A	PB 400	21.9	8	10	24.5	17.5	16	32.5	24	22	10	75	15.9	1150462081	24-BCE-L12-G3/8E	•
L	15	G 1/2 A	PB 400	26.9	11	12	28	21	21.5	43	30	27	12	110	28.4	1150472081	24-BCE-L15-G1/2E	•
L	18	G 1/2 A	PB 400	26.9	11	15	28	20.5	21.5	43	30	27	12	110	32.0	1150482081	24-BCE-L18-G1/2E	•
L	22	G 3/4 A	PB 250	32.9	15	19	34.5	27	24	48	36	32	16	210	48.5	1150492081	24-BCE-L22-G3/4E	•
L	28	G 1 A	PB 250	39.9	19	24	39	31.5	30.5	59	46	41	18	380	88.2	1150502081	24-BCE-L28-G1E	•
L	35	G 1 1/4 A	PB 250	49.9	24	30	46	35.5	35.5	70	55	50	20	500	150.8	1150512081	24-BCE-L35-G11/4E	•
L	42	G 1 1/2 A	PB 250	55.9	31	36	51	40	40.5	80	65	55	22	650	234.1	1150522081	24-BCE-L42-G11/2E	•
S	6	G 1/4 A	PB 500	18.9	5	4	23	16	13.5	27	19	19	10	50	8.7	1150532081	24-BCE-S6-G1/4E	•
S	8	G 1/4 A	PB 500	18.9	5	5	23	16	13.5	27	19	19	10	50	10.3	1150542081	24-BCE-S8-G1/4E	•
S	10	G 3/8 A	PB 500	21.9	8	7	25.5	18	16	32.5	24	22	10	80	17.0	1150552081	24-BCE-S10-G3/8E	•
S	12	G 3/8 A	PB 400	21.9	8	8	25.5	18	16	32.5	24	22	10	80	17.9	1150562081	24-BCE-S12-G3/8E	•
S	14	G 1/2 A	PB 400	26.9	11	10	30	22	19.5	41	30	27	12	160	30.3	1150572081	24-BCE-S14-G1/2E	•
S	16	G 1/2 A	PB 400	26.9	11	12	30	21.5	21.5	43	30	27	12	160	31.6	1150582081	24-BCE-S16-G1/2E	•
S	20	G 3/4 A	PB 315	32.9	15	16	36.5	26	24	48	36	32	16	250	51.8	1150592081	24-BCE-S20-G3/4E	•
S	25	G 1 A	PB 250	39.9	19	20	43	31	30.5	59	46	41	18	380	103.0	1150602081	24-BCE-S25-G1E	•
S	30	G 1 1/4 A	PB 250	49.9	24	25	50	36.5	35.5	70	55	50	20	600	163.7	1150612081	24-BCE-S30-G11/4E	•
S	38	G 1 1/2 A	PB 250	55.9	31	32	57	41	40.5	80	65	55	22	700	262.7	1150622081	24-BCE-S38-G11/2E	•

• Standard size

T banjo couplings

Compact design - **high-pressure**

Male thread: metric fine thread, parallel

With soft seal for recesses

DIN 3852 / ISO 9974

d4 narrow

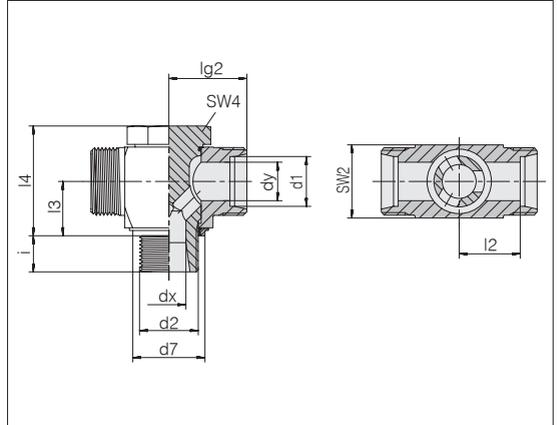

Series	d2	Pressure	d7	dx	dy	lg2	l2	l3	l4	SW2	SW4	i	Nm -10 %	kg/100 ca.	Order-No.	Designation	
Tube OD d1																	
L 6	M 10 x 1	PB 500	14.9	4	4	20	13	10	21	14	14	8	25	4.9	1154202081	24-BCT-L6-M10E-P	•
L 8	M 12 x 1.5	PB 500	17.9	5	6	21	14	13.5	27	19	19	10	50	8.7	1154212081	24-BCT-L8-M12E-P	•
L 10	M 14 x 1.5	PB 500	19.9	5	8	22	15	13.5	27	19	19	10	60	9.5	1150972081	24-BCT-L10-M14E-P	•
L 12	M 16 x 1.5	PB 400	21.9	8	10	24.5	17.5	16	32.5	24	22	10	80	15.6	1154232081	24-BCT-L12-M16E-P	•
L 12	M 18 x 1.5	PB 315	23.9	8	10	27	20	18.5	36	24	22	10	100	24.1	1154242081	24-BCT-L12-M18E-P	•
L 15	M 18 x 1.5	PB 400	23.9	9.5	12	27	20	18.5	37	27	24	10	100	21.7	1154252081	24-BCT-L15-M18E-P	•
L 18	M 22 x 1.5	PB 400	27.9	11	15	28	20.5	21.5	43	30	27	12	140	30.3	1154262081	24-BCT-L18-M22E-P	•
L 22	M 26 x 1.5	PB 250	31.9	15	19	34.5	27	24	48	36	32	16	180	47.2	1154272081	24-BCT-L22-M26E-P	•
L 28	M 33 x 2	PB 250	39.9	19	24	39	31.5	30.5	59	46	41	18	380	90.1	1154282081	24-BCT-L28-M33E-P	•
L 35	M 42 x 2	PB 250	49.9	24	30	46	35.5	35.5	70	55	50	20	500	153.5	1154292081	24-BCT-L35-M42E-P	•
L 42	M 48 x 2	PB 250	55.9	31	36	51	40	40.5	80	65	55	22	600	218.8	1154302081	24-BCT-L42-M48E-P	•
S 6	M 12 x 1.5	PB 500	17.9	5	4	23	16	13.5	27	19	19	10	50	9.8	1154312081	24-BCT-S6-M12E-P	•
S 8	M 14 x 1.5	PB 500	19.9	5	5	23	16	13.5	27	19	19	10	60	10.8	1154322081	24-BCT-S8-M14E-P	•
S 10	M 16 x 1.5	PB 500	21.9	8	7	25.5	18	16	32.5	24	22	10	80	16.9	1154332081	24-BCT-S10-M16E-P	•
S 12	M 18 x 1.5	PB 400	23.9	9.5	8	27	19.5	18.5	37	27	24	10	110	22.2	1154342081	24-BCT-S12-M18E-P	•
S 16	M 22 x 1.5	PB 400	27.9	11	12	30	21.5	21.5	43	30	27	12	140	31.2	1154362081	24-BCT-S16-M22E-P	•
S 20	M 27 x 2	PB 315	32.9	15	16	36.5	26	24	48	36	32	16	300	51.2	1154372081	24-BCT-S20-M27E-P	•
S 25	M 33 x 2	PB 250	39.9	19	20	43	31	30.5	59	46	41	18	380	95.2	1154382081	24-BCT-S25-M33E-P	•
S 30	M 42 x 2	PB 250	49.9	24	25	50	36.5	35.5	70	55	50	20	600	157.8	1154392081	24-BCT-S30-M42E-P	•
S 38	M 48 x 2	PB 250	55.9	31	32	57	41	40.5	80	65	55	22	700	239.0	1154402081	24-BCT-S38-M48E-P	•

• Standard size



T banjo couplings

Compact design - **high-pressure**

Male thread: Whitworth pipe thread, parallel

With soft seal for recesses

DIN 3852 / ISO 1179

d4 narrow

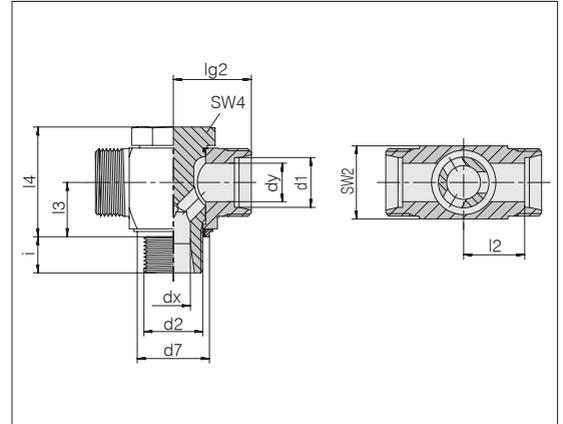

Series	d2	Pressure	d7	dx	dy	lg2	l2	l3	l4	SW2	SW4	i	Nm -10 %	kg/100 ca.	Order-No.	Designation	
L	6	G 1/8 A	PB 500	14.9	4	4	20	13	10	21	14	14	8	25	4.8	1154412081	24-BCT-L6-G1/8E-P •
L	8	G 1/4 A	PB 500	18.9	5	6	21	14	13.5	27	19	19	10	45	9.0	1154432081	24-BCT-L8-G1/4E-P •
L	10	G 1/4 A	PB 500	18.9	5	8	22	15	13.5	27	19	19	10	45	9.2	1154442081	24-BCT-L10-G1/4E-P •
L	12	G 3/8 A	PB 400	21.9	8	10	24.5	17.5	16	32.5	24	22	10	75	15.4	1154462081	24-BCT-L12-G3/8E-P •
L	15	G 1/2 A	PB 400	26.9	11	12	28	21	21.5	43	30	27	12	110	28.7	1154472081	24-BCT-L15-G1/2E-P •
L	18	G 1/2 A	PB 400	26.9	11	15	28	20.5	21.5	43	30	27	12	110	29.4	1154482081	24-BCT-L18-G1/2E-P •
L	22	G 3/4 A	PB 250	32.9	15	19	35.5	28	24	48	36	32	16	210	49.2	1154492081	24-BCT-L22-G3/4E-P •
L	28	G 1 A	PB 250	39.9	19	24	39	31.5	30.5	59	46	41	18	380	89.9	1154502081	24-BCT-L28-G1E-P •
L	35	G 1 1/4 A	PB 250	49.9	24	30	46	35.5	35.5	70	55	50	20	500	152.9	1154512081	24-BCT-L35-G11/4E-P •
L	42	G 1 1/2 A	PB 250	55.9	31	36	51	40	40.5	80	65	55	22	650	218.8	1154522081	24-BCT-L42-G11/2E-P •
S	6	G 1/4 A	PB 500	18.9	5	4	23	16	13.5	27	19	19	10	50	10.0	1154532081	24-BCT-S6-G1/4E-P •
S	8	G 1/4 A	PB 500	18.9	5	5	23	16	13.5	27	19	19	10	50	10.5	1154542081	24-BCT-S8-G1/4E-P •
S	10	G 3/8 A	PB 500	21.9	8	7	25.5	18	16	32.5	24	22	10	80	16.7	1154552081	24-BCT-S10-G3/8E-P •
S	12	G 3/8 A	PB 400	21.9	8	8	25.5	18	16	32.5	24	22	10	80	17.2	1154562081	24-BCT-S12-G3/8E-P •
S	14	G 1/2 A	PB 400	26.9	11	10	30	22	19.5	41	30	27	12	160	29.4	1154572081	24-BCT-S14-G1/2E-P •
S	16	G 1/2 A	PB 400	26.9	11	12	30	21.5	21.5	43	30	27	12	160	30.3	1154582081	24-BCT-S16-G1/2E-P •
S	20	G 3/4 A	PB 315	32.9	15	16	36.5	26	24	48	36	32	16	250	51.1	1154592081	24-BCT-S20-G3/4E-P •
S	25	G 1 A	PB 250	39.9	19	20	43	31	30.5	59	46	41	18	380	95.0	1154602081	24-BCT-S25-G1E-P •
S	30	G 1 1/4 A	PB 250	49.9	24	25	50	36.5	35.5	70	55	50	20	600	157.3	1154612081	24-BCT-S30-G11/4E-P •
S	38	G 1 1/2 A	PB 250	55.9	31	32	57	41	40.5	80	65	55	22	700	239.0	1154622081	24-BCT-S38-G11/2E-P •

● Standard size

Rotary couplings

Male thread: metric fine thread, parallel

Sealed with PEFLEX profile seal ring

Standard profile seal ring material is NBR

Design version: of square bar steel

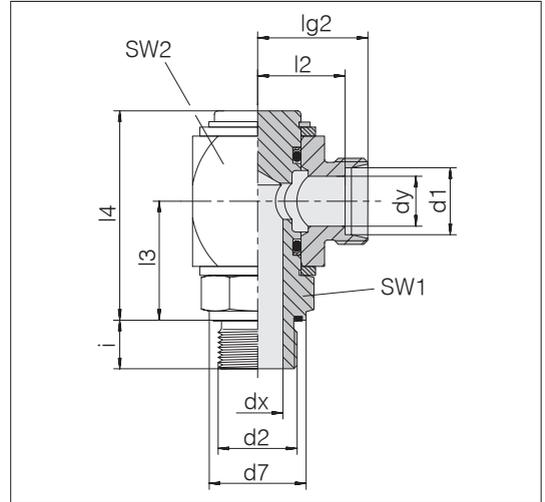

Series	d2	Pressure	d7	dx	dy	lg2	l2	l3	l4	SW1	SW2	i	Nm -10 %	kg/100 ca.	Order-No.	Designation	
L	6	M 10 x 1	PB 100	14.9	4	4	23.5	16.5	26.5	47	22	27	8	25	18.1	1175001081	24-RCE-L6-M10E-C10
L	8	M 12 x 1.5	PB 100	16.9	6	6	23.5	16.5	26.5	47	22	27	12	35	18.4	1175051081	24-RCE-L8-M12E-C10
L	10	M 14 x 1.5	PB 100	18.9	7	8	24.5	17.5	26.5	47	22	27	12	50	19.3	1175101081	24-RCE-L10-M14E-C10
L	12	M 16 x 1.5	PB 100	21.9	9	8	24.5	17.5	26.5	47	22	27	12	80	18.9	1175151081	24-RCE-L12-M16E-C10
L	15	M 18 x 1.5	PB 100	23.9	11	12	30.5	23.5	33.5	58.5	27	36	12	100	40.8	1175201081	24-RCE-L15-M18E-C10
L	15	M 22 x 1.5	PB 100	26.9	14	12	30.5	23.5	33.5	58.5	27	36	14	160	41.3	1175221081	24-RCE-L15-M22E-C10
L	18	M 22 x 1.5	PB 100	26.9	14	13	30.5	23	33.5	58.5	27	36	14	160	41.0	1175251081	24-RCE-L18-M22E-C10
L	22	M 26 x 1.5	PB 100	31.9	17	18	34.5	27	38	65.5	32	41	16	220	54.3	1175301081	24-RCE-L22-M26E-C10
L	28	M 33 x 2	PB 100	39.9	22	22	37	29.5	42.5	72	41	46	18	300	78.4	1175351081	24-RCE-L28-M33E-C10
S	6	M 12 x 1.5	PB 400	16.9	4	4	25.5	18.5	26.5	47	22	27	12	50	20.0	1175501081	24-RCE-S6-M12E-C10
S	8	M 14 x 1.5	PB 400	18.9	5	5	26	18.5	26.5	47	22	27	12	60	20.3	1175551081	24-RCE-S8-M14E-C10
S	10	M 16 x 1.5	PB 400	21.9	7	7	25.5	18	26.5	47	22	27	12	100	20.3	1175601081	24-RCE-S10-M16E-C10
S	12	M 18 x 1.5	PB 400	23.9	8	8	30.5	23	33.5	58.5	27	36	12	120	42.7	1175651081	24-RCE-S12-M18E-C10
S	14	M 20 x 1.5	PB 400	25.9	10	10	33	25	33.5	58.5	27	36	14	170	43.2	1175701081	24-RCE-S14-M20E-C10
S	16	M 22 x 1.5	PB 400	26.9	12	12	33	24.5	33.5	58.5	27	36	14	190	42.9	1175751081	24-RCE-S16-M22E-C10
S	20	M 27 x 2	PB 400	32.9	16	16	36.5	26	38	65.5	32	41	16	300	56.8	1175801081	24-RCE-S20-M27E-C10
S	25	M 33 x 2	PB 250	39.9	20	20	41	29	42.5	72	41	46	18	450	79.0	1175851081	24-RCE-S25-M33E-C10

● Standard size

These couplings are designed for slow rotary and swivelling motions of angles up to 360° and temperatures of up to 70 °C.

Example for comp. : DVWE06LMOMD



Rotary couplings

Male thread: Whitworth pipe thread, parallel

Sealed with PEFLEX profile seal ring

Standard profile seal ring material is NBR

Design version: of square bar steel

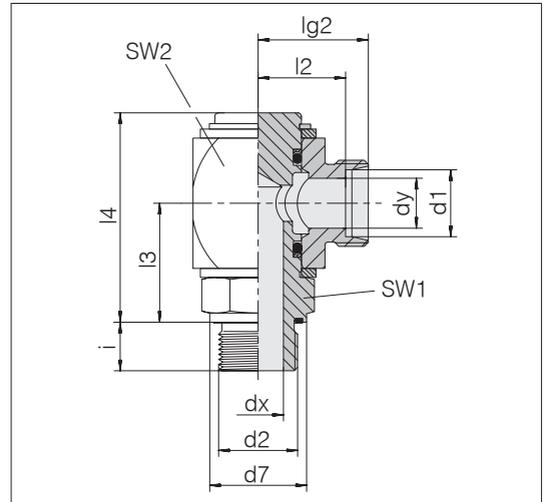

Series	d2	Pressure	d7	dx	dy	lg2	l2	l3	l4	SW1	SW2	i	Nm -10 %	kg/100 ca.	Order-No.	Designation	
L	6	G 1/8 A	PB 100	13.9	4	4	23.5	16.5	26.5	47	22	27	8	25	18.9	1176001081	24-RCE-L6-G1/8E-C10
L	8	G 1/4 A	PB 100	18.9	6	6	23.5	16.5	26.5	47	22	27	12	50	19.4	1176051081	24-RCE-L8-G1/4E-C10
L	10	G 1/4 A	PB 100	18.9	7	8	24.5	17.5	26.5	47	22	27	12	50	18.9	1176101081	24-RCE-L10-G1/4E-C10
L	12	G 3/8 A	PB 100	21.9	9	8	24.5	17.5	26.5	47	22	27	12	80	18.9	1176151081	24-RCE-L12-G3/8E-C10
L	15	G 1/2 A	PB 100	26.9	11	12	30.5	23.5	33.5	58.5	27	36	14	170	41.8	1176201081	24-RCE-L15-G1/2E-C10
L	18	G 1/2 A	PB 100	26.9	14	13	30.5	23	33.5	58.5	27	36	14	170	40.4	1176251081	24-RCE-L18-G1/2E-C10
L	22	G 3/4 A	PB 100	31.9	17	18	34.5	27	38	65.5	32	41	16	240	55.1	1176301081	24-RCE-L22-G3/4E-C10
L	28	G 1 A	PB 100	39.9	22	22	37	29.5	42.5	72	41	46	18	370	77.3	1176351081	24-RCE-L28-G1E-C10
S	6	G 1/4 A	PB 400	18.9	4	4	25.5	18.5	26.5	47	22	27	12	60	20.0	1176501081	24-RCE-S6-G1/4E-C10
S	8	G 1/4 A	PB 400	18.9	5	5	26	18.5	26.5	47	22	27	12	60	20.3	1176551081	24-RCE-S8-G1/4E-C10
S	10	G 3/8 A	PB 400	21.9	7	7	25.5	18	26.5	47	22	27	12	110	20.7	1176601081	24-RCE-S10-G3/8E-C10
S	12	G 3/8 A	PB 400	21.9	8	8	30.5	23	33.5	58.5	27	36	12	110	42.4	1176651081	24-RCE-S12-G3/8E-C10
S	14	G 1/2 A	PB 400	26.9	10	10	33	25	33.5	58.5	27	36	14	200	43.7	1176701081	24-RCE-S14-G1/2E-C10
S	16	G 1/2 A	PB 400	26.9	12	12	33	24.5	33.5	58.5	27	36	14	200	42.4	1176751081	24-RCE-S16-G1/2E-C10
S	20	G 3/4 A	PB 400	31.9	16	16	36.5	26	38	65.5	32	41	16	320	57.4	1176801081	24-RCE-S20-G3/4E-C10
S	25	G 1 A	PB 250	39.9	20	20	41	29	42.5	72	41	46	18	500	98.0	1176851081	24-RCE-S25-G1E-C10

These couplings are designed for slow rotary and swivelling motions of angles up to 360° and temperatures of up to 70 °C.

Example for comp. :
DVWE06LROMD

Adjustable couplings with tube socket, plug-in version

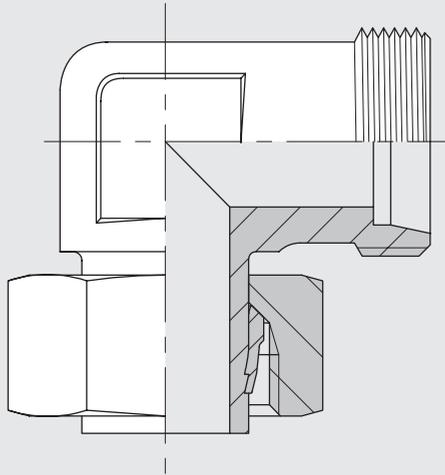

Adjustable elbow couplings

Plug-in version

Tube socket pre-assembled

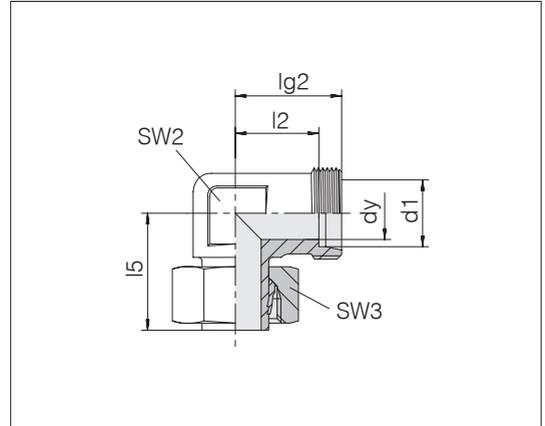

Series	Tube OD	Pressure	d_y	l_{g2}	l_2	l_5	SW2	SW3	kg/100 ca.	Order-No.	Designation
L	6	PN 315	4	19	12	26	12	14	2.8	0158032007	24-SWE-L6
L	8	PN 315	6	21	14	27.5	12	17	3.8	0158082007	24-SWE-L8
L	10	PN 315	8	22	15	29	14	19	5.0	0158132007	24-SWE-L10
L	12	PN 315	10	24	17	29.5	17	22	6.6	0158182007	24-SWE-L12
L	15	PN 315	12	28	21	32.5	19	27	11.5	0158232007	24-SWE-L15
L	18	PN 315	15	31	23.5	35.5	24	32	17.8	0158282007	24-SWE-L18
L	22	PN 160	19	35	27.5	38.5	27	36	23.5	0158332007	24-SWE-L22
L	28	PN 160	24	38	30.5	41.5	36	41	34.1	0158382007	24-SWE-L28
L	35	PN 160	30	45	34.5	51	41	50	57.7	0158432007	24-SWE-L35
L	42	PN 160	36	51	40	56	50	60	87.2	0158482007	24-SWE-L42
S	6	PN 630	4	23	16	27	12	17	4.4	0158532007	24-SWE-S6
S	8	PN 630	5	24	17	27.5	14	19	5.9	0158582007	24-SWE-S8
S	10	PN 630	7	25	17.5	30	17	22	8.3	0158632007	24-SWE-S10
S	12	PN 630	8	29	21.5	31	17	24	10.5	0158682007	24-SWE-S12
S	14	PN 630	10	30	22	35	19	27	14.6	0158732007	24-SWE-S14
S	16	PN 400	12	33	24.5	36.5	24	30	19.9	0158782007	24-SWE-S16
S	20	PN 400	16	37	26.5	44.5	27	36	29.4	0158832007	24-SWE-S20
S	25	PN 400	20	42	30	50	36	46	54.1	0158882007	24-SWE-S25
S	30	PN 400	25	49	35.5	55	41	50	76.2	0158932007	24-SWE-S30
S	38	PN 315	32	57	41	63	50	60	118.9	0158982007	24-SWE-S38

Example for comp. :
EWW06LOMD



Adjustable T couplings

Plug-in version

Tube socket pre-assembled

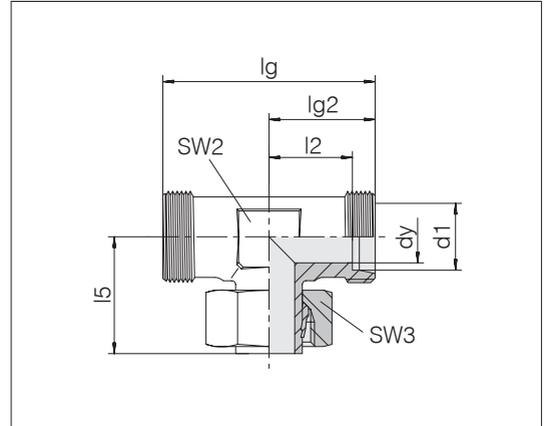

Series	Tube OD	Pressure	dy	lg	lg2	l2	l5	SW2	SW3	kg/100 ca.	Order-No.	Designation
L	6	PN 315	4	38	19	12	26	12	14	3.8	0160032007	24-SWT-L6
L	8	PN 315	6	42	21	14	27.5	12	17	4.8	0160082007	24-SWT-L8
L	10	PN 315	8	44	22	15	29	14	19	6.0	0160132007	24-SWT-L10
L	12	PN 315	10	48	24	17	29.5	17	22	7.9	0160182007	24-SWT-L12
L	15	PN 315	12	56	28	21	32.5	19	27	14.2	0160232007	24-SWT-L15
L	18	PN 315	15	62	31	23.5	35.5	24	32	21.1	0160282007	24-SWT-L18
L	22	PN 160	19	70	35	27.5	38.5	27	36	27.8	0160332007	24-SWT-L22
L	28	PN 160	24	76	38	30.5	41.5	36	41	38.6	0160382007	24-SWT-L28
L	35	PN 160	30	90	45	34.5	51	41	50	66.0	0160432007	24-SWT-L35
L	42	PN 160	36	102	51	40	56	50	60	101.8	0160482007	24-SWT-L42
S	6	PN 630	4	46	23	16	27	12	17	5.8	0160532007	24-SWT-S6
S	8	PN 630	5	48	24	17	27.5	14	19	7.6	0160582007	24-SWT-S8
S	10	PN 630	7	50	25	17.5	30	17	22	10.3	0160632007	24-SWT-S10
S	12	PN 630	8	58	29	21.5	31	17	24	13.5	0160682007	24-SWT-S12
S	14	PN 630	10	60	30	22	35	19	27	17.9	0160732007	24-SWT-S14
S	16	PN 400	12	66	33	24.5	36.5	24	30	24.1	0160782007	24-SWT-S16
S	20	PN 400	16	74	37	26.5	44.5	27	36	34.8	0160832007	24-SWT-S20
S	25	PN 400	20	84	42	30	50	36	46	63.0	0160882007	24-SWT-S25
S	30	PN 400	25	98	49	35.5	55	41	50	90.8	0160932007	24-SWT-S30
S	38	PN 315	32	114	57	41	63	50	60	141.7	0160982007	24-SWT-S38

Example for comp. :
EVT06LOMD

Adjustable L couplings

Plug-in version

Tube socket pre-assembled

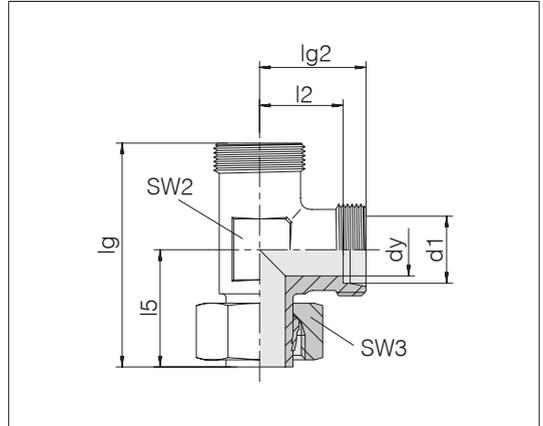

Series	Tube OD	Pressure	dy	lg	lg2	l2	l5	SW2	SW3	kg/100 ca.	Order-No.	Designation
L	6	PN 315	4	45	19	12	26	12	14	3.4	0162032007	24-SWL-L6
L	8	PN 315	6	48.5	21	14	27.5	12	17	4.7	0162082007	24-SWL-L8
L	10	PN 315	8	51	22	15	29	14	19	6.0	0162132007	24-SWL-L10
L	12	PN 315	10	53.5	24	17	29.5	17	22	7.9	0162182007	24-SWL-L12
L	15	PN 315	12	60.5	28	21	32.5	19	27	13.7	0162232007	24-SWL-L15
L	18	PN 315	15	66.5	31	23.5	35.5	24	32	20.8	0162282007	24-SWL-L18
L	22	PN 160	19	73.5	35	27.5	38.5	27	36	27.2	0162332007	24-SWL-L22
L	28	PN 160	24	79.5	38	30.5	41.5	36	41	39.1	0162382007	24-SWL-L28
L	35	PN 160	30	96	45	34.5	51	41	50	66.1	0162432007	24-SWL-L35
L	42	PN 160	36	107	51	40	56	50	60	100.6	0162482007	24-SWL-L42
S	6	PN 630	4	50	23	16	27	12	17	5.6	0162532007	24-SWL-S6
S	8	PN 630	5	51.5	24	17	27.5	14	19	7.8	0162582007	24-SWL-S8
S	10	PN 630	7	55	25	17.5	30	17	22	10.3	0162632007	24-SWL-S10
S	12	PN 630	8	60	29	21.5	31	17	24	13.4	0162682007	24-SWL-S12
S	14	PN 630	10	65	30	22	35	19	27	17.7	0162732007	24-SWL-S14
S	16	PN 400	12	69.5	33	24.5	36.5	24	30	22.5	0162782007	24-SWL-S16
S	20	PN 400	16	81.5	37	26.5	44.5	27	36	34.8	0162832007	24-SWL-S20
S	25	PN 400	20	92	42	30	50	36	46	63.5	0162882007	24-SWL-S25
S	30	PN 400	25	104	49	35.5	55	41	50	91.4	0162932007	24-SWL-S30
S	38	PN 315	32	120	57	41	63	50	60	141.7	0162982007	24-SWL-S38

Example for comp. :
EVL06LOMD



Straight stud standpipe adapters

Male thread: metric fine thread, parallel

Sealing with seal edge

Tube socket pre-assembled

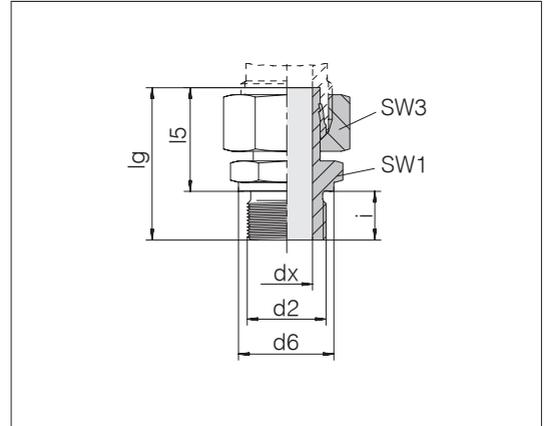

Series	d2	Pressure	d6	dx	lg	l5	SW1	SW3	i	Nm -10 %	kg/100 ca.	Order-No.	Designation	
Tube OD														
L	6	M 10 x 1	PN 315	14	3.5	32.5	24.5	14	14	8	20	0164032007	24-SWSDS-L6-M10B	•
L	8	M 12 x 1.5	PN 315	17	5	38.5	26.5	17	17	12	30	0164082007	24-SWSDS-L8-M12B	•
L	10	M 14 x 1.5	PN 315	19	7	39.5	27.5	19	19	12	50	0164132007	24-SWSDS-L10-M14B	•
L	12	M 16 x 1.5	PN 315	21	9	42.5	30.5	22	22	12	70	0164182007	24-SWSDS-L12-M16B	•
L	12	M 18 x 1.5	PN 315	23	8.8	42.5	30.5	24	22	12	90	1199172007	24-SWSDS-L12-M18B	•
L	12	M 22 x 1.5	PN 315	27	9	46	32	27	22	14	140	0185712007	24-SWSDS-L12-M22B	•
L	15	M 18 x 1.5	PN 315	23	11	43.5	31.5	24	27	12	90	0164232007	24-SWSDS-L15-M18B	•
L	18	M 22 x 1.5	PN 315	27	14	45.5	31.5	27	32	14	140	0164282007	24-SWSDS-L18-M22B	•
L	22	M 26 x 1.5	PN 160	31	17	48.5	32.5	32	36	16	190	0164332007	24-SWSDS-L22-M26B	•
L	28	M 33 x 2	PN 160	39	22.5	53	35	41	41	18	300	0164382007	24-SWSDS-L28-M33B	•
L	35	M 42 x 2	PN 160	49	28.5	62.5	42.5	50	50	20	500	0164432007	24-SWSDS-L35-M42B	•
L	42	M 48 x 2	PN 160	55	35	68.5	46.5	55	60	22	600	0164482007	24-SWSDS-L42-M48B	•
S	6	M 12 x 1.5	PB 630	17	3.5	39	27	17	17	12	45	0164532007	24-SWSDS-S6-M12B	•
S	8	M 14 x 1.5	PB 630	19	4.5	41.5	29.5	19	19	12	60	0164582007	24-SWSDS-S8-M14B	•
S	10	M 16 x 1.5	PB 630	21	6	44	32	22	22	12	80	0164632007	24-SWSDS-S10-M16B	•
S	12	M 18 x 1.5	PB 630	23	7	46	34	24	24	12	120	0164682007	24-SWSDS-S12-M18B	•
S	14	M 20 x 1.5	PB 630	25	9	50.5	36.5	27	27	14	160	0164732007	24-SWSDS-S14-M20B	•
S	16	M 22 x 1.5	PB 400	27	11	51	37	27	30	14	170	0164782007	24-SWSDS-S16-M22B	•
S	20	M 27 x 2	PB 400	32	15	59	43	32	36	16	280	0164832007	24-SWSDS-S20-M27B	•
S	25	M 33 x 2	PB 400	39	18	66	48	41	46	18	450	0164882007	24-SWSDS-S25-M33B	•
S	30	M 42 x 2	PB 250	49	23	71	51	50	50	20	540	0164932007	24-SWSDS-S30-M42B	•
S	38	M 48 x 2	PB 250	55	29	82	60	55	60	22	700	0164982007	24-SWSDS-S38-M48B	•

● Standard size

At PB 630, the safety is 2.

Example for comp. : EVGE06LM

Straight stud standpipe adapters

Male thread: Whitworth pipe thread, parallel

Sealing with seal edge

Tube socket pre-assembled

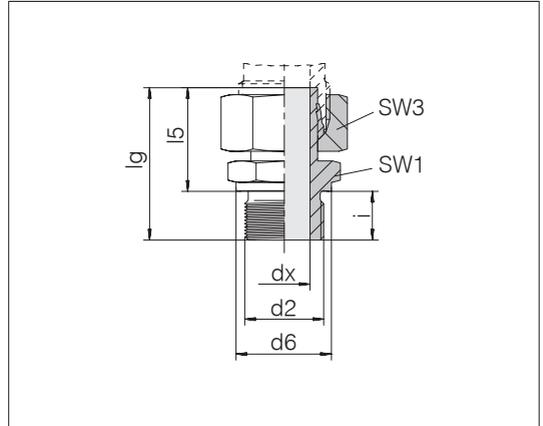

Series	d2	Pressure	d6	dx	lg	l5	SW1	SW3	i	Nm -10 %	kg/100 ca.	Order-No.	Designation
L 6	G 1/8 A	PN 315	14	3.5	32.5	24.5	14	14	8	20	2.4	0165032007	24-SWSDS-L6-G1/8B •
L 8	G 1/4 A	PN 315	18	4.5	41.5	29.5	19	17	12	50	4.6	0165082007	24-SWSDS-L8-G1/4B •
L 10	G 1/4 A	PN 315	18	6	39.5	27.5	19	19	12	50	5.1	0165132007	24-SWSDS-L10-G1/4B •
L 12	G 1/4 A	PN 315	18	6	45.5	33.5	19	22	12	50	7.0	0197372007	24-SWSDS-L12-G1/4B
L 12	G 3/8 A	PN 315	22	7	46	34	22	22	12	80	8.2	0165182007	24-SWSDS-L12-G3/8B •
L 12	G 1/2 A	PN 315	26	7	48.5	34.5	27	22	14	140	9.8	0197382007	24-SWSDS-L12-G1/2B
L 15	G 3/8 A	PN 315	22	9	43.5	31.5	22	27	12	80	9.6	0186042007	24-SWSDS-L15-G3/8B
L 15	G 1/2 A	PN 315	26	11	46	32	27	27	14	140	11.9	0165232007	24-SWSDS-L15-G1/2B •
L 18	G 1/2 A	PN 315	26	14	45.5	31.5	27	32	14	140	13.6	0165282007	24-SWSDS-L18-G1/2B •
L 22	G 3/4 A	PN 160	32	18	48.5	32.5	32	36	16	190	18.7	0165332007	24-SWSDS-L22-G3/4B •
L 28	G 1 A	PN 160	39	22.5	53	35	41	41	18	330	27.1	0165382007	24-SWSDS-L28-G1B •
L 35	G 1 1/4 A	PN 160	49	29	62.5	42.5	50	50	20	540	44.8	0165432007	24-SWSDS-L35-G11/4B •
L 42	G 1 1/2 A	PN 160	55	35	68.5	46.5	55	60	22	630	60.7	0165482007	24-SWSDS-L42-G11/2B •
S 6	G 1/4 A	PB 630	18	3.5	39	27	19	17	12	60	4.9	0165532007	24-SWSDS-S6-G1/4B •
S 8	G 1/4 A	PB 630	18	4.5	41.5	29.5	19	19	12	60	5.8	0165582007	24-SWSDS-S8-G1/4B •
S 10	G 3/8 A	PB 630	22	6	44	32	22	22	12	100	8.7	0165632007	24-SWSDS-S10-G3/8B •
S 12	G 1/4 A	PB 630	18	5	45.5	33.5	19	24	12	60	8.4	0194242007	24-SWSDS-S12-G1/4B
S 12	G 3/8 A	PB 630	22	7	46	34	22	24	12	100	10.0	0165682007	24-SWSDS-S12-G3/8B •
S 12	G 1/2 A	PB 400	26	7	48.5	34.5	27	24	14	160	14.9	0189612007	24-SWSDS-S12-G1/2B
S 14	G 1/2 A	PB 630	26	9	50.5	36.5	27	27	14	160	15.4	0165732007	24-SWSDS-S14-G1/2B •
S 16	G 1/2 A	PB 400	26	11	51	37	27	30	14	160	16.3	0165782007	24-SWSDS-S16-G1/2B •
S 20	G 3/4 A	PB 400	32	15	59	43	32	36	16	280	26.0	0165832007	24-SWSDS-S20-G3/4B •
S 25	G 1 A	PB 400	39	18	66	48	41	46	18	440	48.5	0165882007	24-SWSDS-S25-G1B •
S 30	G 1 1/4 A	PB 250	49	22.5	71	51	50	50	20	580	67.2	0165932007	24-SWSDS-S30-G11/4B •
S 38	G 1 1/2 A	PB 250	55	28.5	82	60	55	60	22	700	96.9	0165982007	24-SWSDS-S38-G11/2B •

• Standard size

Example for comp. :
EVGE06LR



Straight stud standpipe adapters

Male thread: metric fine thread, parallel

Sealed with PEFLEX profile seal ring

Standard profile seal ring material is NBR

Tube socket pre-assembled

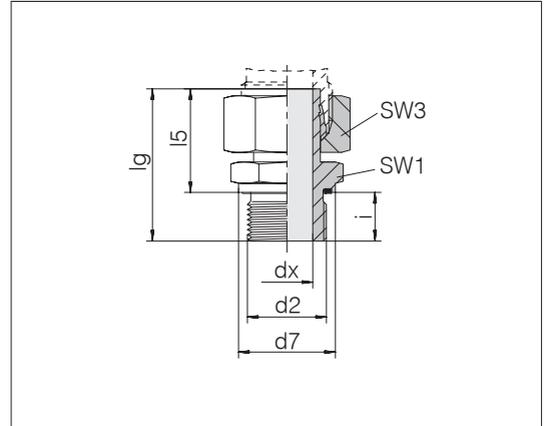

Series	d2	Pressure	d7	dx	lg	l5	SW1	SW3	i	Nm -10 %	kg/100 ca.	Order-No.	Designation
L 6	M 10 x 1	PN 315	13.9	3.5	32.5	24.5	14	14	8	15	2.3	0174802007	24-SWSDS-L6-M10E •
L 8	M 12 x 1.5	PN 315	16.9	5	38.5	26.5	17	17	12	25	3.9	0174812007	24-SWSDS-L8-M12E •
L 10	M 14 x 1.5	PN 315	18.9	7	39.5	27.5	19	19	12	50	4.9	0174822007	24-SWSDS-L10-M14E •
L 12	M 16 x 1.5	PN 315	21.9	9	42.5	30.5	22	22	12	70	6.8	0174832007	24-SWSDS-L12-M16E •
L 15	M 18 x 1.5	PN 315	23.9	11	43.5	31.5	24	27	12	90	9.8	0174842007	24-SWSDS-L15-M18E •
L 18	M 22 x 1.5	PN 315	26.9	14	45.5	31.5	27	32	14	130	14.0	0174852007	24-SWSDS-L18-M22E •
L 22	M 22 x 1.5	PN 315	26.9	14	46.5	32.5	27	36	14	130	14.0	1196272000	24-SWSDS-L22-M22E •
L 22	M 26 x 1.5	PN 160	31.9	17	48.5	32.5	32	36	16	180	19.4	0174862007	24-SWSDS-L22-M26E •
L 28	M 33 x 2	PN 160	39.9	22.5	53	35	41	41	18	230	27.0	0174872007	24-SWSDS-L28-M33E •
L 35	M 42 x 2	PN 160	49.9	28.5	62.5	42.5	50	50	20	330	45.3	0174882007	24-SWSDS-L35-M42E •
L 42	M 48 x 2	PN 160	54.9	35	68.5	46.5	55	60	22	500	62.7	0174892007	24-SWSDS-L42-M48E •
S 6	M 12 x 1.5	PN 630	16.9	3.5	39	27	17	17	12	50	4.3	0174902007	24-SWSDS-S6-M12E •
S 8	M 14 x 1.5	PN 630	18.9	4.5	41.5	29.5	19	19	12	60	6.0	0174912007	24-SWSDS-S8-M14E •
S 10	M 16 x 1.5	PN 630	21.9	6	44	32	22	22	12	80	8.6	0174922007	24-SWSDS-S10-M16E •
S 12	M 18 x 1.5	PN 630	23.9	7	46	34	24	24	12	90	10.9	0174932007	24-SWSDS-S12-M18E •
S 14	M 20 x 1.5	PN 630	25.9	9	50.5	36.5	27	27	14	130	14.6	0174942007	24-SWSDS-S14-M20E •
S 16	M 22 x 1.5	PN 400	26.9	11	51	37	27	30	14	130	16.7	0174952007	24-SWSDS-S16-M22E •
S 20	M 27 x 2	PN 400	31.9	15	59	43	32	36	16	200	25.4	0174962007	24-SWSDS-S20-M27E •
S 25	M 33 x 2	PN 400	39.9	18	66	48	41	46	18	250	48.6	0174972007	24-SWSDS-S25-M33E •
S 30	M 42 x 2	PN 400	49.9	23	71	51	50	50	20	500	66.2	0174982007	24-SWSDS-S30-M42E •
S 38	M 48 x 2	PN 315	54.9	29	82	60	55	60	22	600	93.3	0174992007	24-SWSDS-S38-M48E •

● Standard size

Example for comp. :
EVGE06LMED

Straight stud standpipe adapters

Male thread: Whitworth pipe thread, parallel

Sealed with PEFLEX profile seal ring

Standard profile seal ring material is NBR

Tube socket pre-assembled

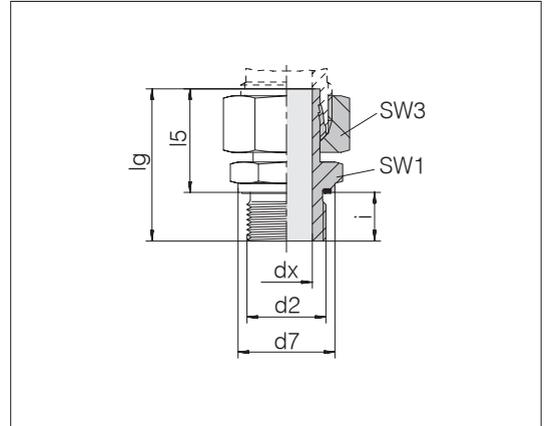

Series	d2	Pressure	d7	dx	lg	l5	SW1	SW3	i	Nm -10 %	kg/100 ca.	Order-No.	Designation
L 6	G 1/8 A	PN 315	13.9	3.5	32.5	24.5	14	14	8	20	2.3	0177802007	24-SWSDS-L6-G1/8E •
L 6	G 1/4 A	PN 315	18.9	3.5	38	26	19	14	12	50	3.9	0177172007	24-SWSDS-L6-G1/4E
L 8	G 1/4 A	PN 315	18.9	4.5	41.5	29.5	19	17	12	50	4.6	0177812007	24-SWSDS-L8-G1/4E •
L 8	G 3/8 A	PN 315	21.9	4.5	43	31	22	17	14	80	6.0	1177072007	24-SWSDS-L8-G3/8E
L 10	G 1/4 A	PN 315	18.9	6	39.5	27.5	19	19	12	50	5.0	0177822007	24-SWSDS-L10-G1/4E •
L 10	G 3/8 A	PN 315	21.9	7	41	29	22	19	12	80	6.4	1177042007	24-SWSDS-L10-G3/8E
L 12	G 1/4 A	PN 315	18.9	6	45.5	33.5	19	22	12	50	7.0	1177032007	24-SWSDS-L12-G1/4E
L 12	G 3/8 A	PN 315	21.9	7	46	34	22	22	12	80	8.0	0177832007	24-SWSDS-L12-G3/8E •
L 12	G 1/2 A	PN 315	26.9	7	48.5	34.5	27	22	14	100	10.1	1177012007	24-SWSDS-L12-G1/2E
L 15	G 3/8 A	PN 315	21.9	9	43.5	31.5	22	27	12	80	9.4	1177052007	24-SWSDS-L15-G3/8E
L 15	G 1/2 A	PN 315	26.9	11	46	32	27	27	14	100	11.7	0177842007	24-SWSDS-L15-G1/2E •
L 18	G 1/2 A	PN 315	26.9	14	45.5	31.5	27	32	14	100	13.4	0177852007	24-SWSDS-L18-G1/2E •
L 22	G 1/2 A	PN 160	26.9	14	46.5	32.5	27	36	14	100	15.4	0177742007	24-SWSDS-L22-G1/2E
L 22	G 3/4 A	PN 160	31.9	18	48.5	32.5	32	36	16	180	18.4	0177862007	24-SWSDS-L22-G3/4E •
L 28	G 1 A	PN 160	39.9	22.5	53	35	41	41	18	230	26.8	0177872007	24-SWSDS-L28-G1E •
L 35	G 1 1/4 A	PN 160	49.9	29	62.5	42.5	50	50	20	330	43.9	0177882007	24-SWSDS-L35-G11/4E •
L 42	G 1 1/2 A	PN 160	54.9	35	68.5	46.5	55	60	22	500	62.3	0177892007	24-SWSDS-L42-G11/2E •
S 6	G 1/4 A	PN 630	18.9	3.5	39	27	19	17	12	60	4.9	0177902007	24-SWSDS-S6-G1/4E •
S 8	G 1/4 A	PN 630	18.9	4.5	41.5	29.5	19	19	12	60	5.8	0177912007	24-SWSDS-S8-G1/4E •
S 10	G 1/4 A	PN 630	18.9	5	43.5	31.5	19	22	12	60	7.2	0177762007	24-SWSDS-S10-G1/4E
S 10	G 3/8 A	PN 630	21.9	6	44	32	22	22	12	90	8.7	0177922007	24-SWSDS-S10-G3/8E •
S 12	G 3/8 A	PN 630	21.9	7	46	34	22	24	12	90	9.9	0177932007	24-SWSDS-S12-G3/8E •
S 12	G 1/2 A	PN 630	26.9	7	48.5	34.5	27	24	14	150	12.8	0177792007	24-SWSDS-S12-G1/2E
S 14	G 1/2 A	PN 630	26.9	9	50.5	36.5	27	27	14	150	15.4	0177942007	24-SWSDS-S14-G1/2E •
S 16	G 1/2 A	PN 400	26.9	11	51	37	27	30	14	150	16.2	0177952007	24-SWSDS-S16-G1/2E •
S 16	G 3/4 A	PN 400	31.9	11	55	39	32	30	16	200	22.7	1177062007	24-SWSDS-S16-G3/4E
S 20	G 3/4 A	PN 400	31.9	15	59	43	32	36	16	200	25.5	0177962007	24-SWSDS-S20-G3/4E •
S 25	G 1 A	PN 400	39.9	18	66	48	41	46	18	250	48.8	0177972007	24-SWSDS-S25-G1E •
S 30	G 1 1/4 A	PN 400	49.9	22.5	71	51	50	50	20	500	66.7	0177982007	24-SWSDS-S30-G11/4E •
S 38	G 1 1/2 A	PN 315	54.9	28.5	82	60	55	60	22	600	95.3	0177992007	24-SWSDS-S38-G11/2E •

• Standard size

Example for comp. :
EVGE06LRED



Straight stud standpipe adapters

Male thread: NPT (ANSI/ASME B 1 - 20.01.1983)

Tube socket pre-assembled

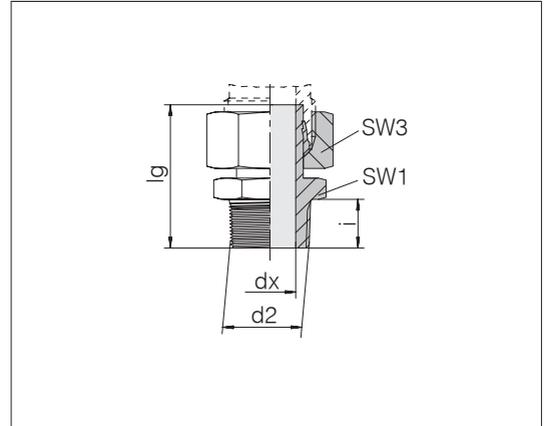

Series	d2	Pressure	dx	lg	SW1	SW3	i	Nm -10 %	kg/100 ca.	Order-No.	Designation	
L	6	1/8 NPT	PN 315	3.5	33	11	14	9.9	15	2.2	0172802007	24-SWSDS-L6-N1/8T
L	8	1/4 NPT	PN 315	5	39.6	14	17	15.1	35	3.5	0172812007	24-SWSDS-L8-N1/4T
L	10	1/4 NPT	PN 315	7	40.6	14	19	15.1	35	4.2	0172822007	24-SWSDS-L10-N1/4T
L	12	3/8 NPT	PN 315	7	43	19	22	15.2	55	7.2	0172832007	24-SWSDS-L12-N3/8T
L	15	1/2 NPT	PN 315	11	48.5	22	27	19.8	110	11.0	0172842007	24-SWSDS-L15-N1/2T
L	18	1/2 NPT	PN 315	13	48	22	32	19.8	110	13.0	0172852007	24-SWSDS-L18-N1/2T
L	22	3/4 NPT	PN 160	17	50	27	36	20.1	175	18.2	0172862007	24-SWSDS-L22-N3/4T
L	28	1 NPT	PN 160	22.5	57	36	41	25	265	25.9	0172872007	24-SWSDS-L28-N1T
L	35	1 1/4 NPT	PN 160	29	65	46	50	25.6	315	42.8	0172882007	24-SWSDS-L35-N11/4T
L	42	1 1/2 NPT	PN 160	35	69	50	60	26	385	57.5	0172892007	24-SWSDS-L42-N11/2T
S	6	1/4 NPT	PN 630	3.5	40	14	17	15.1	35	4.3	0172902007	24-SWSDS-S6-N1/4T
S	8	1/4 NPT	PN 630	4.5	42	14	19	15.1	35	4.9	0172912007	24-SWSDS-S8-N1/4T
S	10	3/8 NPT	PN 630	6	44	19	22	15.2	55	8.0	0172922007	24-SWSDS-S10-N3/8T
S	12	3/8 NPT	PN 630	7	46	19	24	15.2	55	8.6	0172932007	24-SWSDS-S12-N3/8T
S	14	1/2 NPT	PN 630	9	53	22	27	19.8	110	13.8	0172942007	24-SWSDS-S14-N1/2T
S	16	1/2 NPT	PN 400	11	52.8	22	30	19.8	110	14.7	0172952007	24-SWSDS-S16-N1/2T
S	20	3/4 NPT	PN 400	15	60	27	36	20.1	175	23.9	0172962007	24-SWSDS-S20-N3/4T
S	25	1 NPT	PN 400	18	69	36	46	25	265	46.0	0172972007	24-SWSDS-S25-N1T
S	30	1 1/4 NPT	PN 400	22.5	72.6	46	50	25.6	315	65.2	0172982007	24-SWSDS-S30-N11/4T
S	38	1 1/2 NPT	PN 315	28.5	83	50	60	26	385	86.3	0172992007	24-SWSDS-S38-N11/2T

Example for comp. :
EVGE06L1/8NPT

Reducing inserts

with hexagon for locking

Tube socket pre-assembled

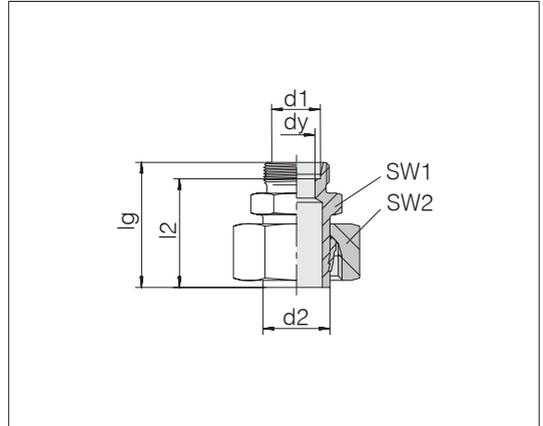

Tube socket d2	Series Tube OD d1	Pressure	dy	lg	l2	SW1	SW2	kg/100 ca.	Order-No.	Designation
L 6	LL 4	PN 100	3	31	27	11	14	2.1	0188462074	24-SWS-L6-LL4
L 8	L 6	PN 315	4	33	26	12	17	2.9	0148052074	24-SWS-L8-L6
L 10	L 6	PN 315	4	34	27	12	19	3.4	0148112074	24-SWS-L10-L6
L 10	L 8	PN 315	6	35	28	14	19	3.8	0148102074	24-SWS-L10-L8
L 12	L 6	PN 315	4	37	30	14	22	4.7	0148172074	24-SWS-L12-L6
L 12	L 8	PN 315	6	37	30	14	22	4.8	0148162074	24-SWS-L12-L8
L 12	L 10	PN 315	8	38	31	17	22	5.2	0148152074	24-SWS-L12-L10
L 12	S 8	PN 315	5	39	32	17	22	5.7	0186092074	24-SWS-L12-S8
L 15	L 6	PN 315	4	38	31	17	27	7.4	0148232074	24-SWS-L15-L6
L 15	L 8	PN 315	6	38	31	17	27	7.5	0148222074	24-SWS-L15-L8
L 15	L 10	PN 315	8	39	32	17	27	7.7	0148212074	24-SWS-L15-L10
L 15	L 12	PN 315	10	40	33	19	27	8.2	0148202074	24-SWS-L15-L12
L 18	L 6	PN 315	4	37.5	30.5	19	32	11.0	0148292074	24-SWS-L18-L6
L 18	L 8	PN 315	6	37.5	30.5	19	32	10.2	0148282074	24-SWS-L18-L8
L 18	L 10	PN 315	8	38.5	31.5	19	32	10.2	0148272074	24-SWS-L18-L10
L 18	L 12	PN 315	10	38.5	31.5	19	32	10.3	0148262074	24-SWS-L18-L12
L 18	L 15	PN 315	12	39.5	32.5	24	32	11.9	0148252074	24-SWS-L18-L15
L 18	S 16	PN 315	12	50	41.5	30	32	19.2	0196612074	24-SWS-L18-S16
L 22	L 6	PN 160	4	41	34	24	36	14.8	0199032074	24-SWS-L22-L6
L 22	L 8	PN 160	6	38.5	31.5	24	36	14.5	0148342074	24-SWS-L22-L8
L 22	L 10	PN 160	8	39.5	32.5	24	36	14.1	0148332074	24-SWS-L22-L10
L 22	L 12	PN 160	10	39.5	32.5	24	36	14.1	0148322074	24-SWS-L22-L12
L 22	L 15	PN 160	12	40.5	33.5	24	36	14.7	0148312074	24-SWS-L22-L15
L 22	L 18	PN 160	15	41.5	34	27	36	16.2	0148302074	24-SWS-L22-L18
L 22	S 20	PN 160	16	50.5	40	32	36	21.5	0198362074	24-SWS-L22-S20
L 28	L 6	PN 160	4	42	35	30	41	19.1	0198652074	24-SWS-L28-L6
L 28	L 8	PN 160	6	42	35	30	41	17.5	0199022074	24-SWS-L28-L8
L 28	L 10	PN 160	8	41	34	30	41	17.8	0148392074	24-SWS-L28-L10
L 28	L 12	PN 160	10	41	34	30	41	18.3	0148382074	24-SWS-L28-L12
L 28	L 15	PN 160	12	42	35	30	41	18.4	0148372074	24-SWS-L28-L15
L 28	L 18	PN 160	15	43	35.5	30	41	19.1	0148362074	24-SWS-L28-L18

Other diameter combinations available upon request.

Example for comp. : KOR08/06LOMD

Continued on following page



Reducing inserts

with hexagon for locking

Tube socket pre-assembled

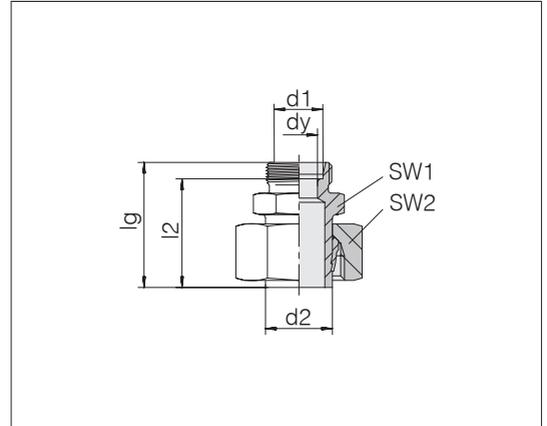

Tube socket d2	Series	Tube OD d1	Pressure	dy	lg	l2	SW1	SW2	kg/100 ca.	Order-No.	Designation
L 28	L	22	PN 160	19	45	37.5	32	41	20.2	0148352074	24-SWS-L28-L22
L 28	S	25	PN 160	20	58	46	41	41	38.7	0197632074	24-SWS-L28-S25
L 35	L	8	PN 160	6	48	41	36	50	27.9	0198712074	24-SWS-L35-L8
L 35	L	10	PN 160	8	49	42	36	50	28.8	0198892074	24-SWS-L35-L10
L 35	L	12	PN 160	10	47.5	40.5	36	50	28.6	0148442074	24-SWS-L35-L12
L 35	L	15	PN 160	12	48.5	41.5	36	50	29.1	0148432074	24-SWS-L35-L15
L 35	L	18	PN 160	15	49.5	42	36	50	28.7	0148422074	24-SWS-L35-L18
L 35	L	22	PN 160	19	51.5	44	36	50	28.8	0148412074	24-SWS-L35-L22
L 35	L	28	PN 160	24	52.5	45	41	50	31.8	0148402074	24-SWS-L35-L28
L 42	L	10	PN 160	8	51	44	46	60	44.2	0199802074	24-SWS-L42-L10
L 42	L	12	PN 160	10	51	44	46	60	45.2	0199812074	24-SWS-L42-L12
L 42	L	15	PN 160	12	52	45	46	60	45.0	0148492074	24-SWS-L42-L15
L 42	L	18	PN 160	15	52	44.5	46	60	46.2	0148482074	24-SWS-L42-L18
L 42	L	22	PN 160	19	54	46.5	46	60	44.9	0148472074	24-SWS-L42-L22
L 42	L	28	PN 160	24	55	47.5	46	60	45.1	0148462074	24-SWS-L42-L28
L 42	L	35	PN 160	30	58	47.5	46	60	47.8	0148452074	24-SWS-L42-L35

Continued on following page

Reducing inserts

with hexagon for locking

Tube socket pre-assembled

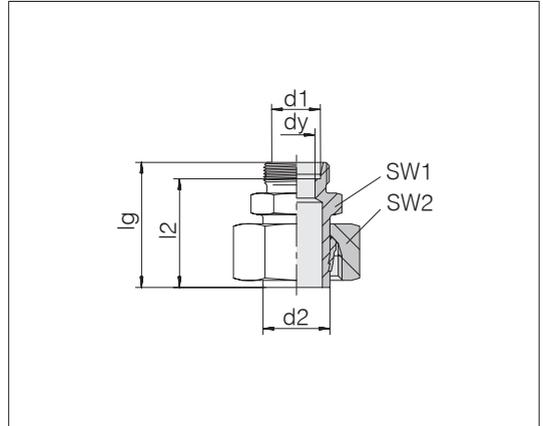

Tube socket d2	Series Tube OD d1	Pressure	dy	lg	l2	SW1	SW2	kg/100 ca.	Order-No.	Designation
S 8	S 6	PN 630	4	37	30	14	19	4.4	0148552074	24-SWS-S8-S6
S 10	S 6	PN 630	4	39	32	14	22	5.9	0148612074	24-SWS-S10-S6
S 10	S 8	PN 630	5	41	34	17	22	6.7	0148602074	24-SWS-S10-S8
S 12	L 12	PN 315	7	38	31	19	24	6.9	0198922074	24-SWS-S12-L12
S 12	S 6	PN 630	4	39	32	14	24	6.6	0148672074	24-SWS-S12-S6
S 12	S 8	PN 630	5	41	34	17	24	7.4	0148662074	24-SWS-S12-S8
S 12	S 10	PN 630	7	41	33.5	19	24	7.8	0148652074	24-SWS-S12-S10
S 14	S 6	PN 630	4	42	35	17	27	9.6	0148732074	24-SWS-S14-S6
S 14	S 8	PN 630	5	44	37	17	27	10.0	0148722074	24-SWS-S14-S8
S 14	S 10	PN 630	7	44	36.5	19	27	10.6	0148712074	24-SWS-S14-S10
S 14	S 12	PN 630	8	46	38.5	22	27	12.0	0148702074	24-SWS-S14-S12
S 16	L 12	PN 315	10	43	36	19	30	11.6	1148022074	24-SWS-S16-L12
S 16	L 15	PN 315	12	46	39	24	30	13.4	0197872074	24-SWS-S16-L15
S 16	S 6	PN 400	4	42	35	17	30	11.1	0148792074	24-SWS-S16-S6
S 16	S 8	PN 400	5	44	37	17	30	11.6	0148782074	24-SWS-S16-S8
S 16	S 10	PN 400	7	44	36.5	19	30	11.9	0148772074	24-SWS-S16-S10
S 16	S 12	PN 400	8	46	38.5	22	30	13.3	0148762074	24-SWS-S16-S12
S 16	S 14	PN 400	10	48	40	24	30	14.7	0148752074	24-SWS-S16-S14
S 20	L 15	PN 315	12	51	44	24	36	18.6	0198902074	24-SWS-S20-L15
S 20	L 18	PN 315	14	51	43.5	27	36	20.6	0198912074	24-SWS-S20-L18
S 20	S 6	PN 400	4	47	40	22	36	7.4	0199012074	24-SWS-S20-S6
S 20	S 8	PN 400	5	48	41	22	36	17.2	0148842074	24-SWS-S20-S8
S 20	S 10	PN 400	7	48	40.5	22	36	16.8	0148832074	24-SWS-S20-S10
S 20	S 12	PN 400	8	50	42.5	22	36	17.9	0148822074	24-SWS-S20-S12
S 20	S 14	PN 400	10	52	44	24	36	19.1	0148812074	24-SWS-S20-S14
S 20	S 16	PN 400	12	52	43.5	27	36	20.3	0148802074	24-SWS-S20-S16
S 25	L 22	PN 160	18	55	47.5	32	46	36.0	0198372074	24-SWS-S25-L22
S 25	L 18	PN 315	15	51	43.5	27	46	31.7	0198622074	24-SWS-S25-L18
S 25	S 6	PN 400	4	51	44	27	46	31.2	0198992074	24-SWS-S25-S6
S 25	S 8	PN 400	5	51	44	27	46	31.5	0199002074	24-SWS-S25-S8
S 25	S 10	PN 400	7	51	43.5	27	46	31.9	0148892074	24-SWS-S25-S10
S 25	S 12	PN 400	8	53	45.5	27	46	32.6	0148882074	24-SWS-S25-S12
S 25	S 14	PN 400	10	55	47	27	46	33.1	0148872074	24-SWS-S25-S14

Continued on following page



Reducing inserts

with hexagon for locking

Tube socket pre-assembled

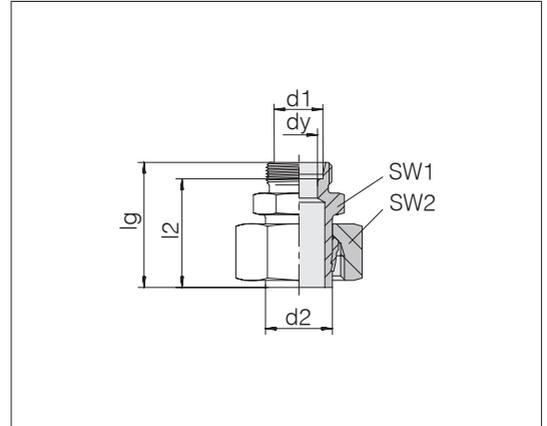

Tube socket d2	Series Tube OD d1	Pressure	dy	lg	l2	SW1	SW2	kg/100 ca.	Order-No.	Designation
S 25	S 16	PN 400	12	55	46.5	27	46	33.2	0148862074	24-SWS-S25-S16
S 25	S 20	PN 400	16	59	48.5	32	46	37.0	0148852074	24-SWS-S25-S20
S 30	S 8	PN 400	5	59	52	32	50	40.9	0198972074	24-SWS-S30-S8
S 30	S 12	PN 400	8	56	48.5	32	50	37.5	0148942074	24-SWS-S30-S12
S 30	S 14	PN 400	10	58	50	32	50	18.1	0148932074	24-SWS-S30-S14
S 30	S 16	PN 400	12	58	49.5	32	50	37.9	0148922074	24-SWS-S30-S16
S 30	S 20	PN 400	16	62	51.5	32	50	39.9	0148912074	24-SWS-S30-S20
S 30	S 25	PN 400	20	66	54	41	50	49.4	0148902074	24-SWS-S30-S25
S 38	S 10	PN 315	7	62	54.5	41	60	28.2	0199872074	24-SWS-S38-S10
S 38	S 12	PN 315	8	62	54.5	41	60	60.9	0199882074	24-SWS-S38-S12
S 38	S 16	PN 315	12	64	55.5	41	60	58.9	0148982074	24-SWS-S38-S16
S 38	S 20	PN 315	16	68	57.5	41	60	60.5	0148972074	24-SWS-S38-S20
S 38	S 25	PN 315	20	72	60	41	60	64.5	0148962074	24-SWS-S38-S25
S 38	S 30	PN 315	25	74	60.5	46	60	71.4	0148952074	24-SWS-S38-S30

24° taper couplings

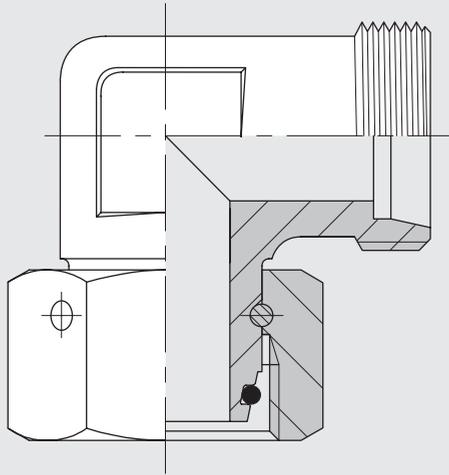

Straight couplings

With taper and O-ring
fit in bore type
W DIN 3861 / ISO 8434-1

Standard O-ring material is FPM/FKM

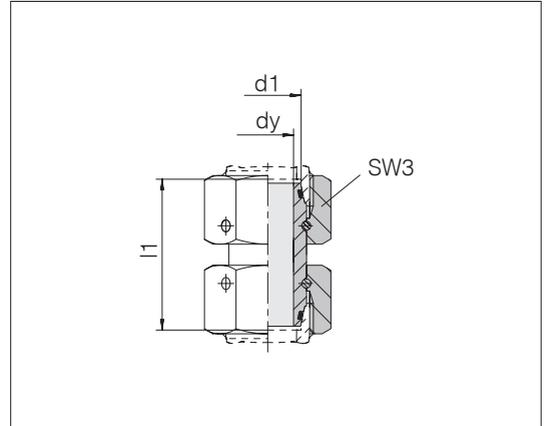

Series	Pressure	dy	l1	SW3	kg/100 ca.	Order-No.	Designation
Tube OD d1							
L 6	PN 500	2.5	33.5	14	2.9	1178342058	24-SW2OS-L6-CP1
L 6	PN 500	2.5	36	14	3.0	1178352058	24-SW2OS-L6-CP2
L 6	PN 500	2.5	39	14	3.1	1178002058	24-SW2OS-L6
L 8	PN 500	4.5	33.5	17	4.4	1178852058	24-SW2OS-L8-CP1
L 8	PN 500	4.5	36	17	4.6	1178372058	24-SW2OS-L8-CP2
L 8	PN 500	4.5	39.5	17	4.6	1178012058	24-SW2OS-L8
L 10	PN 500	6	34	19	5.5	1178472058	24-SW2OS-L10-CP1
L 10	PN 500	6	37	19	5.9	1178382058	24-SW2OS-L10-CP2
L 10	PN 500	6	39.5	19	6.0	1178022058	24-SW2OS-L10
L 12	PN 400	8	34	22	7.4	1178752058	24-SW2OS-L12-CP1
L 12	PN 400	8	37	22	7.7	1178392058	24-SW2OS-L12-CP2
L 12	PN 400	8	39.5	22	7.9	1178032058	24-SW2OS-L12
L 15	PN 400	10	40	27	14.3	1178442058	24-SW2OS-L15-CP12
L 15	PN 400	10	42.5	27	14.8	1178042058	24-SW2OS-L15
L 18	PN 400	13	39	32	17.6	1178452058	24-SW2OS-L18-CP1
L 18	PN 400	13	42.5	32	18.3	1178802058	24-SW2OS-L18-CP2
L 18	PN 400	13	45	32	18.8	1178052058	24-SW2OS-L18
L 22	PN 250	17	44	36	24.4	1178652058	24-SW2OS-L22-CP1
L 22	PN 250	17	46.5	36	25.1	1178812058	24-SW2OS-L22-CP2
L 22	PN 250	17	49.5	36	25.6	1178062058	24-SW2OS-L22
L 28	PN 250	22	48	41	31.2	1178482058	24-SW2OS-L28-CP12
L 28	PN 250	22	51.5	41	31.7	1178072058	24-SW2OS-L28
L 35	PN 250	28	52	50	45.1	1178822058	24-SW2OS-L35-CP1
L 35	PN 250	28	57.5	50	48.3	1178832058	24-SW2OS-L35-CP2
L 35	PN 250	28	61	50	49.8	1178082058	24-SW2OS-L35
L 42	PN 250	34	57.5	60	74.6	1178842058	24-SW2OS-L42-CP12
L 42	PN 250	34	62.5	60	78.1	1178092058	24-SW2OS-L42

● Standard size

Example for comp. :
GZ06LVIT

Continued on following page

Straight couplings

With taper and O-ring
fit in bore type
W DIN 3861 / ISO 8434-1

Standard O-ring material is FPM/FKM

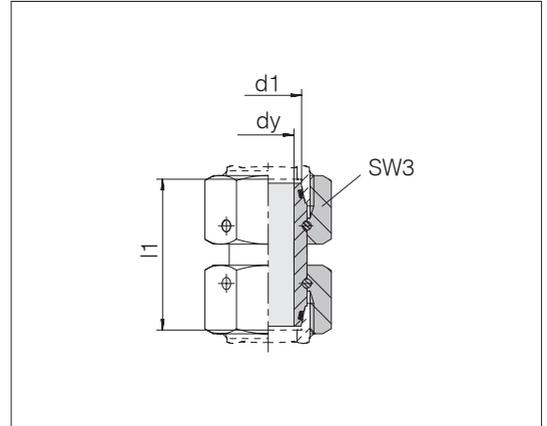

Series	Tube OD	Pressure	d_y	l_1	SW3	kg/100 ca.	Order-No.	Designation
S	6	PN 800	2.5	33	17	4.2	1178862058	24-SW2OS-S6-CP1
S	6	PN 800	2.5	39	17	4.6	1178872058	24-SW2OS-S6-CP2
S	6	PN 800	2.5	40.5	17	4.7	1178102058	24-SW2OS-S6 •
S	8	PN 800	4	34	19	5.6	1178882058	24-SW2OS-S8-CP1
S	8	PN 800	4	39	19	6.0	1178892058	24-SW2OS-S8-CP2
S	8	PN 800	4	40.5	19	6.1	1178112058	24-SW2OS-S8 •
S	10	PN 800	6	35	22	7.7	1178902058	24-SW2OS-S10-CP1
S	10	PN 800	6	43.5	22	8.5	1178122058	24-SW2OS-S10-CP2 •
S	12	PN 630	8	38	24	9.7	1178912058	24-SW2OS-S12-CP1
S	12	PN 630	8	44	24	10.4	1178132058	24-SW2OS-S12-CP2 •
S	14	PN 630	9	41	27	14.4	1178922058	24-SW2OS-S14-CP1
S	14	PN 630	9	48.5	27	15.6	1178142058	24-SW2OS-S14-CP2 •
S	16	PN 630	11	42	30	17.5	1178932058	24-SW2OS-S16-CP1
S	16	PN 630	11	49	30	18.6	1178152058	24-SW2OS-S16-CP2 •
S	20	PN 420	14	48	36	26.1	1178942058	24-SW2OS-S20-CP1
S	20	PN 420	14	60.5	36	29.6	1178162058	24-SW2OS-S20-CP2 •
S	25	PN 420	16	73	46	63.1	1178712058	24-SW2OS-S25-LG73
S	25	PN 420	16	107	46	80.4	1178722058	24-SW2OS-S25-LG107
S	25	PN 420	18	54.5	46	51.7	1178952058	24-SW2OS-S25-CP1
S	25	PN 420	18	65.5	46	56.4	1178962058	24-SW2OS-S25-CP2
S	25	PN 420	18	67.5	46	56.9	1178172058	24-SW2OS-S25 •
S	30	PN 420	23	62	50	63.1	1178702058	24-SW2OS-S30-CP1
S	30	PN 420	23	72.5	50	68.6	1178182058	24-SW2OS-S30-CP2 •
S	38	PN 420	30	67	60	86.7	1178692058	24-SW2OS-S38-CP1
S	38	PN 420	30	83	60	99.6	1178192058	24-SW2OS-S38-CP2 •

• Standard size

Straight reducing couplings

With taper and O-ring
fit in bore type
W DIN 3861 / ISO 8434-1

Standard O-ring material is FPM/FKM

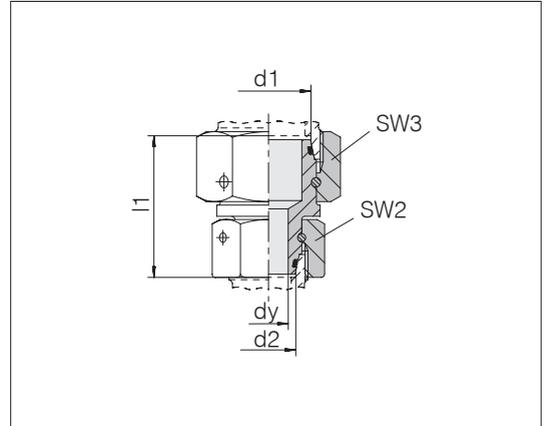

Series	Series	Pressure	dy	l1	SW2	SW3	kg/100	Order-No.	Designation
Tube OD	Tube OD						ca.		
d1	d2								
L 6	S 6	PN 500	2.5	34	17	14	3.7	1180262058	24-SW2OS-L6-S6-CP1
L 6	S 6	PN 500	2.5	37.5	17	14	3.9	1178232058	24-SW2OS-L6-S6-CP2
L 8	L 6	PN 500	2.5	34	14	17	3.8	1180002058	24-SW2OS-L8-L6-CP1
L 8	S 8	PN 500	4	34.5	19	17	5.3	1180272058	24-SW2OS-L8-S8-CP1
L 10	L 6	PN 500	2.5	34.5	14	19	4.4	1178662058	24-SW2OS-L10-L6-CP1
L 10	L 8	PN 500	4.5	34.5	17	19	5.2	1180012058	24-SW2OS-L10-L8-CP1
L 10	S 10	PN 500	6	35	22	19	6.8	1180282058	24-SW2OS-L10-S10-CP1
L 10	S 10	PN 500	6	40	22	19	7.2	1178242058	24-SW2OS-L10-S10-CP2
L 12	L 6	PN 400	2.5	34.5	14	22	5.4	1180022058	24-SW2OS-L12-L6-CP1
L 12	L 8	PN 400	4.5	34.5	17	22	6.2	1180032058	24-SW2OS-L12-L8-CP1
L 12	L 10	PN 400	6	34.5	19	22	6.8	1180042058	24-SW2OS-L12-L10-CP1
L 12	L 10	PN 400	6	37.5	19	22	7.1	1178682058	24-SW2OS-L12-L10-CP2
L 12	S 12	PN 400	8	37.5	24	22	8.9	1180292058	24-SW2OS-L12-S12-CP1
L 12	S 12	PN 400	8	40.5	24	22	9.3	1178252058	24-SW2OS-L12-S12-CP2
L 15	L 8	PN 400	4.5	38	17	27	9.6	1178612058	24-SW2OS-L15-L8-CP12
L 15	L 10	PN 400	6	38	19	27	10.5	1178222058	24-SW2OS-L15-L10-CP12
L 15	L 12	PN 400	8	39	22	27	11.4	1178432058	24-SW2OS-L15-L12-CP1
L 18	L 10	PN 400	8	37.5	19	32	12.2	1180062058	24-SW2OS-L18-L10-CP1
L 18	L 12	PN 400	8	37.5	22	32	13.1	1180072058	24-SW2OS-L18-L12-CP1
L 18	L 15	PN 400	10	40.5	27	32	16.5	1180082058	24-SW2OS-L18-L15-CP1
L 18	L 15	PN 400	10	45	27	32	17.3	1178202058	24-SW2OS-L18-L15
L 18	S 16	PN 400	11	41.5	30	32	18.2	1180302058	24-SW2OS-L18-S16-CP1
L 22	L 12	PN 250	8	43.5	22	36	18.1	1180092058	24-SW2OS-L22-L12-CP1
L 22	L 15	PN 250	10	43.5	27	36	20.2	1180102058	24-SW2OS-L22-L15-CP12
L 22	L 18	PN 250	13	44	32	36	22.1	1178212058	24-SW2OS-L22-L18-CP1
L 22	S 20	PN 250	14	47	36	36	25.9	1180312058	24-SW2OS-L22-S20-CP1
L 22	S 20	PN 250	14	53.5	36	36	27.5	1178262058	24-SW2OS-L22-S20-CP2
L 28	L 15	PN 250	10	46	27	41	24.8	1180112058	24-SW2OS-L28-L15
L 28	L 18	PN 250	13	46	32	41	26.0	1178622058	24-SW2OS-L28-L18-CP2
L 28	L 22	PN 250	17	46	36	41	28.2	117832058	24-SW2OS-L28-L22-CP1
L 28	S 25	PN 250	18	50.5	46	41	40.8	1180322058	24-SW2OS-L28-S25-CP1

Example for comp. :
GZR08/06LVIT

Continued on following page



Straight reducing couplings

With taper and O-ring
fit in bore type
W DIN 3861 / ISO 8434-1

Standard O-ring material is FPM/FKM

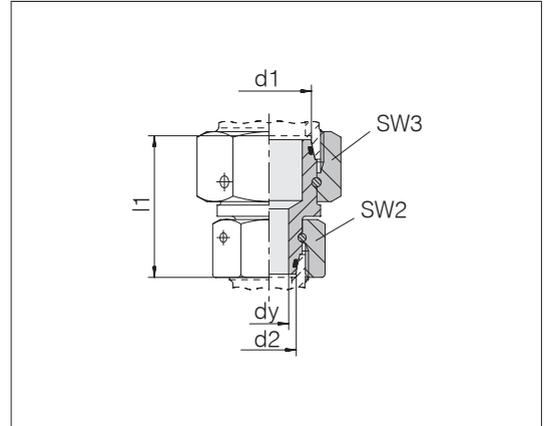

Series	Tube OD	Series	Tube OD	Pressure	dy	l1	SW2	SW3	kg/100 ca.	Order-No.	Designation
d1	d2										
L	35	L	18	PN 250	13	51	32	50	37.5	1180122058	24-SW2OS-L35-L18-CP12
L	35	L	22	PN 250	17	51	36	50	38.4	1180132058	24-SW2OS-L35-L22-CP1
L	35	L	28	PN 250	18	51	41	50	40.3	1180142058	24-SW2OS-L35-L28-CP1
L	35	L	28	PN 250	18	52.5	41	50	41.0	1178672058	24-SW2OS-L35-L28-CP2
L	35	S	30	PN 250	23	59	50	50	55.8	1180332058	24-SW2OS-L35-S30-CP1
L	42	L	22	PN 250	17	54	36	60	55.7	1180152058	24-SW2OS-L42-L22
L	42	L	28	PN 250	18	54	41	60	57.5	1178632058	24-SW2OS-L42-L28-CP2
L	42	L	35	PN 250	28	56.5	50	60	62.5	1178642058	24-SW2OS-L42-L35-CP1
L	42	S	38	PN 250	30	62	60	60	78.3	1180342058	24-SW2OS-L42-S38-CP1
L	42	S	38	PN 250	30	66	60	60	84.1	1178282058	24-SW2OS-L42-S38-CP2
S	8	S	6	PN 800	2.5	34	17	19	5.2	1180162058	24-SW2OS-S8-S6-CP1
S	10	S	6	PN 800	2.5	34.5	17	22	6.2	1180172058	24-SW2OS-S10-S6-CP1
S	10	S	8	PN 800	4	34.5	19	22	6.8	1180182058	24-SW2OS-S10-S8-CP1
S	10	S	8	PN 800	4	41	19	22	7.7	1178492058	24-SW2OS-S10-S8-CP2
S	12	S	6	PN 630	2.5	37.5	17	24	7.6	1180192058	24-SW2OS-S12-S6-CP1
S	12	S	8	PN 630	4	37.5	19	24	8.0	1178742058	24-SW2OS-S12-S8-CP1
S	12	S	10	PN 630	6	38	22	24	9.0	1178502058	24-SW2OS-S12-S10-CP1
S	16	L	15	PN 400	10	41	27	30	16.1	1180352058	24-SW2OS-S16-L15-CP1
S	16	L	15	PN 400	10	45	27	30	16.8	1178292058	24-SW2OS-S16-L15-CP2
S	16	S	10	PN 630	6	41.5	22	30	13.5	1178522058	24-SW2OS-S16-S10-CP1
S	16	S	12	PN 630	8	41.5	24	30	14.1	1178532058	24-SW2OS-S16-S12-CP1
S	20	L	18	PN 400	13	47	32	36	23.9	1180362058	24-SW2OS-S20-L18-CP1
S	20	S	12	PN 420	8	47	24	36	19.8	1180202058	24-SW2OS-S20-S12-CP1
S	20	S	12	PN 420	8	52	24	36	21.4	1178542058	24-SW2OS-S20-S12-CP2
S	20	S	16	PN 420	11	47.5	30	36	23.0	1178552058	24-SW2OS-S20-S16-CP1
S	25	L	22	PN 250	17	50.5	36	46	38.9	1180372058	24-SW2OS-S25-L22-CP1
S	25	L	18	PN 400	13	47.5	32	46	35.4	1178762058	24-SW2OS-S25-L18-CP1
S	25	S	16	PN 420	11	51	30	46	36.2	1178562058	24-SW2OS-S25-S16-CP1
S	25	S	20	PN 420	14	53	36	46	40.2	1178572058	24-SW2OS-S25-S20

Continued on following page

Straight reducing couplings

With taper and O-ring
fit in bore type
W DIN 3861 / ISO 8434-1

Standard O-ring material is FPM/FKM

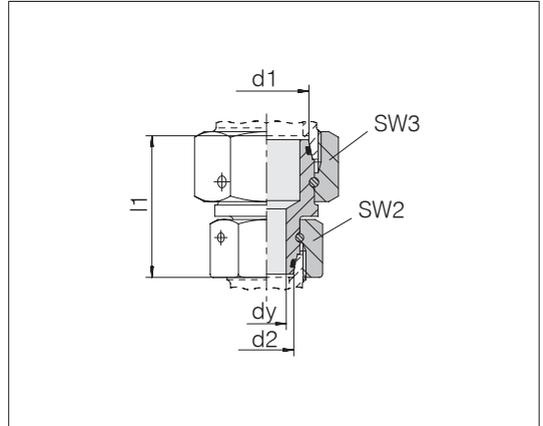

Series Tube OD d1	Series Tube OD d2	Pressure	dy	l1	SW2	SW3	kg/100 ca.	Order-No.	Designation
S 30	L 28	PN 250	22	58	41	50	51.9	1178272058	24-SW2OS-S30-L28-CP1
S 30	S 16	PN 420	11	58.5	30	50	44.9	1180212058	24-SW2OS-S30-S16-CP1
S 30	S 20	PN 420	14	59	36	50	47.9	1180222058	24-SW2OS-S30-S20-CP1
S 30	S 25	PN 420	18	60.5	46	50	58.9	1180232058	24-SW2OS-S30-S25-CP1
S 30	S 25	PN 420	18	69.5	46	50	65.2	1178582058	24-SW2OS-S30-S25
S 38	L 35	PN 250	28	61.5	50	60	70.3	1178732058	24-SW2OS-S38-L35-CP1
S 38	S 20	PN 420	14	61.5	36	60	62.5	1180242058	24-SW2OS-S38-S20-CP1
S 38	S 25	PN 420	18	63	46	60	72.7	1178592058	24-SW2OS-S38-S25-CP1
S 38	S 30	PN 420	23	66.5	50	60	77.2	1180252058	24-SW2OS-S38-S30
S 38	S 30	PN 420	23	78	50	60	89.1	1178602058	24-SW2OS-S38-S30-CP2

Cross couplings

With taper and O-ring

Standard O-ring material is FPM/FKM

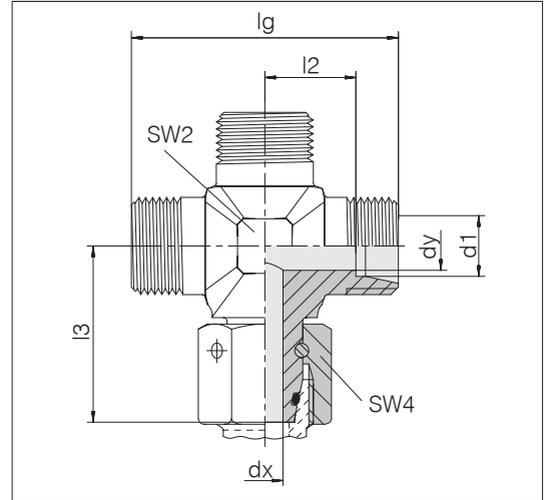

Series	Pressure	dx	dy	l_g	l_2	l_3	SW2	SW4	Order-No.	Designation
L 8	PN 315	4	8	56	21	27.5	17	17	1196702058	24-SWOK-L8
L 10	PN 315	6	8	58	22	29	19	19	1196962058	24-SWOK-L10
L 12	PN 315	8	10	62	24	29.5	22	22	1196952058	24-SWOK-L12
L 15	PN 315	10	12	70	28	32.5	24	27	1196262058	24-SWOK-L15
L 18	PN 315	13	15	68	26.5	38.5	27	32	1196792058	24-SWOK-L18
L 42	PN 250	34	36	102	40	56	50	60	1194942058	24-SWOK-L42

Adjustable elbow couplings

With taper and O-ring

Standard O-ring material is FPM/FKM

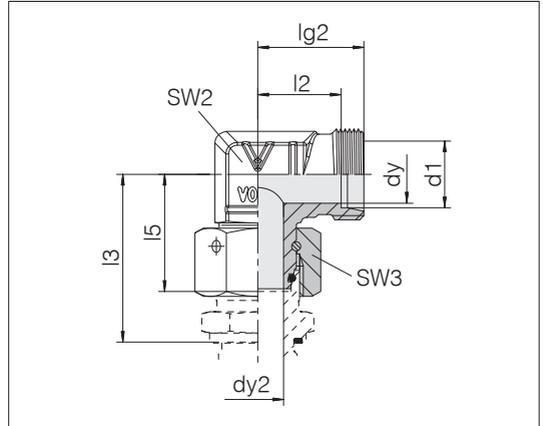

Series	Pressure	dy	dy2	lg2	l2	l3	l5	SW2	SW3	kg/100 ca.	Order-No.	Designation
Tube OD d1												
L 6	PN 500	4	2.5	19	12	34.5	26	12	14	4.1	1158032058	24-SWOE-L6-P
L 8	PN 500	6	4	21	14	37.5	27.5	14	17	6.2	1158082058	24-SWOE-L8-P
L 10	PN 500	8	6	22	15	40	29	14	19	5.3	1158132058	24-SWOE-L10
L 12	PN 400	10	8	24	17	42	29.5	17	22	10.1	1158182058	24-SWOE-L12
L 15	PN 400	12	10	28	21	46	32.5	19	27	12.9	1158232058	24-SWOE-L15
L 18	PN 400	15	13	31	23.5	50	35.5	24	32	18.6	1158282058	24-SWOE-L18
L 22	PN 250	19	17	35	27.5	55	38.5	27	36	25.3	1158332058	24-SWOE-L22
L 28	PN 250	24	22	38	30.5	59	41.5	36	41	34.2	1158382058	24-SWOE-L28
L 35	PN 250	30	28	45	34.5	68.5	51	41	50	57.4	1158432058	24-SWOE-L35
L 42	PN 250	36	34	51	40	75	56	50	60	103.0	1158482058	24-SWOE-L42
S 6	PN 800	4	2.5	23	16	40	27	14	17	6.2	1158532058	24-SWOE-S6-P
S 8	PN 800	5	4	24	17	42.5	27.5	17	19	8.5	1158582058	24-SWOE-S8-P
S 10	PN 800	7	6	25	17.5	45	30	19	22	12.2	1158632058	24-SWOE-S10-P
S 12	PN 630	8	8	29	21.5	48	31	17	24	10.8	1158682058	24-SWOE-S12
S 14	PN 630	10	9	30	22	54	35	19	27	14.9	1158732058	24-SWOE-S14
S 16	PN 630	12	11	33	24.5	55	36.5	24	30	20.1	1158782058	24-SWOE-S16
S 20	PN 420	16	14	37	26.5	65	44.5	27	36	30.5	1158832058	24-SWOE-S20
S 25	PN 420	20	18	42	30	73	50	36	46	55.4	1158882058	24-SWOE-S25
S 30	PN 420	25	23	49	35.5	78.5	55	41	50	77.9	1158932058	24-SWOE-S30
S 38	PN 420	32	30	57	41	89	63	50	60	118.6	1158982058	24-SWOE-S38

Example for comp. :
EW06LVITOMD
ISO 8434-1-SWOE-L6-St



Adjustable 45° elbow couplings

With taper and O-ring

Standard O-ring material is FPM/FKM

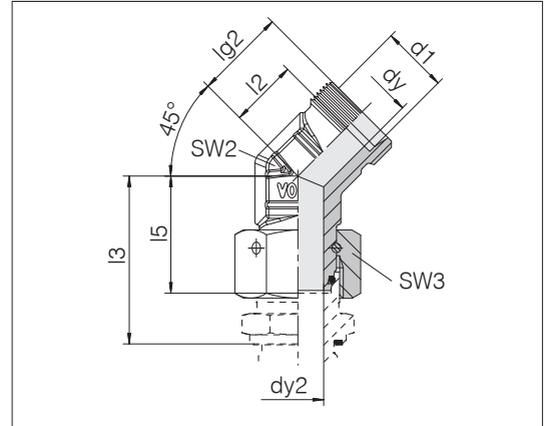

Series	Tube OD	Pressure	dy	dy2	lg2	l2	l3	l5	SW2	SW3	kg/100 ca.	Order-No.	Designation
L	6	PN 500	4	2.5	21	14	34.5	26	19	14	6.9	1170032058	24-SWOE45-L6
L	8	PN 500	6	4	22	15	37.5	27.5	19	17	7.0	1170082058	24-SWOE45-L8
L	10	PN 500	8	6	23	16	40	29	19	19	7.8	1170132058	24-SWOE45-L10
L	12	PN 400	10	8	24	17	42	29.5	19	22	8.6	1170182058	24-SWOE45-L12
L	15	PN 400	12	10	24	17	46	32.5	19	27	12.6	1170232058	24-SWOE45-L15
L	18	PN 400	15	13	26.5	19	50	35.5	24	32	17.8	1170282058	24-SWOE45-L18
L	22	PN 250	19	17	30	22.5	55	38.5	27	36	23.6	1170332058	24-SWOE45-L22
L	28	PN 250	24	22	32	24.5	59	41.5	36	41	33.6	1170382058	24-SWOE45-L28
L	35	PN 250	30	28	37.5	27	68.5	51	41	50	54.6	1170432058	24-SWOE45-L35
L	42	PN 250	36	34	37	27	75	56	50	60	83.6	1170482058	24-SWOE45-L42
S	6	PN 800	4	2.5	23	16	40	27	19	17	7.3	1170532058	24-SWOE45-S6
S	8	PN 800	5	4	23	16	42.5	27.5	19	19	8.2	1170582058	24-SWOE45-S8
S	10	PN 800	7	6	24	16.5	45	30	19	22	9.5	1170632058	24-SWOE45-S10
S	12	PN 630	8	8	24.5	17	48	31	19	24	11.2	1170682058	24-SWOE45-S12
S	14	PN 630	10	9	25	17	54	35	19	27	13.6	1170732058	24-SWOE45-S14
S	16	PN 630	12	11	27.5	19	55	36.5	24	30	18.8	1170782058	24-SWOE45-S16
S	20	PN 420	16	14	32	21.5	65	44.5	27	36	28.6	1170832058	24-SWOE45-S20
S	25	PN 420	20	18	35	23	73	50	36	46	52.3	1170882058	24-SWOE45-S25
S	30	PN 420	25	23	37.5	24	78.5	55	41	50	69.7	1170932058	24-SWOE45-S30
S	38	PN 420	32	30	44	28	89	63	50	60	106.8	1170982058	24-SWOE45-S38

Example for comp. :
 EVO6LVITOMD
 ISO 8434-1-SWOE45-L6-St

Adjustable T couplings

With taper and O-ring

Standard O-ring material is FPM/FKM

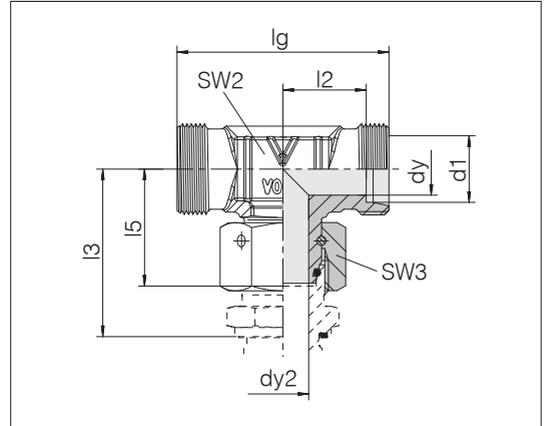

Series	Pressure	dy	dy2	lg	l2	l3	l5	SW2	SW3	kg/100 ca.	Order-No.	Designation
Tube OD d1												
L 6	PN 500	4	2.5	38	12	34.5	26	12	14	4.9	1160032058	24-SWOT-L6-P
L 8	PN 500	6	4	42	14	37.5	27.5	14	17	6.9	1160082058	24-SWOT-L8-P
L 10	PN 500	8	6	44	15	40	29	14	19	9.2	1160132058	24-SWOT-L10-HB
L 12	PN 400	10	8	48	17	42	29.5	19	22	12.0	1160182058	24-SWOT-L12-P
L 15	PN 400	12	10	56	21	46	32.5	19	27	15.4	1160232058	24-SWOT-L15
L 18	PN 400	15	13	62	23.5	50	35.5	24	32	21.5	1160282058	24-SWOT-L18
L 22	PN 250	19	17	70	27.5	55	38.5	27	36	27.7	1160332058	24-SWOT-L22
L 28	PN 250	24	22	76	30.5	59	41.5	36	41	39.7	1160382058	24-SWOT-L28
L 35	PN 250	30	28	90	34.5	68.5	51	41	50	68.0	1160432058	24-SWOT-L35
L 42	PN 250	36	34	102	40	75	56	50	60	113.8	1160482058	24-SWOT-L42
S 6	PN 800	4	2.5	46	16	40	27	14	17	7.7	1160532058	24-SWOT-S6-P
S 8	PN 800	5	4	48	17	42.5	27.5	17	19	10.5	1160582058	24-SWOT-S8-P
S 10	PN 800	7	6	50	17.5	45	30	19	22	14.0	1160632058	24-SWOT-S10-P
S 12	PN 630	8	8	58	21.5	48	31	17	24	13.5	1160682058	24-SWOT-S12
S 14	PN 630	10	9	60	22	54	35	19	27	18.1	1160732058	24-SWOT-S14
S 16	PN 630	12	11	66	24.5	55	36.5	24	30	24.6	1160782058	24-SWOT-S16
S 20	PN 420	16	14	74	26.5	65	44.5	27	36	35.6	1160832058	24-SWOT-S20-HB
S 25	PN 420	20	18	84	30	73	50	36	46	63.7	1160882058	24-SWOT-S25
S 30	PN 420	25	23	98	35.5	78.5	55	41	50	91.6	1160932058	24-SWOT-S30
S 38	PN 420	32	30	114	41	89	63	50	60	147.8	1160982058	24-SWOT-S38

Example for comp. :
ET06LVITOMD
ISO 8434-1-SWORT-L6-St



Adjustable L couplings

With taper and O-ring

Standard O-ring material is FPM/FKM

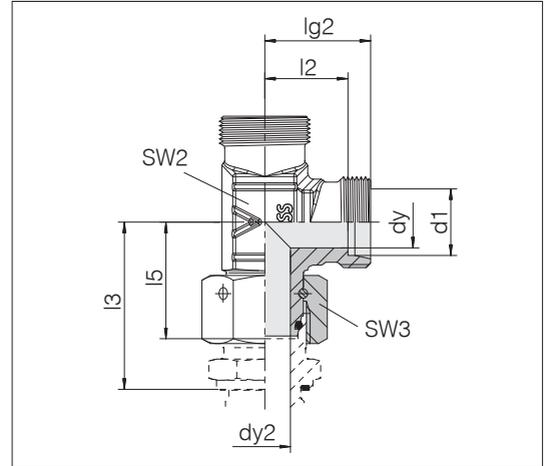

Series	Pressure	dy	dy2	lg2	l2	l3	l5	SW2	SW3	kg/100 ca.	Order-No.	Designation
L 6	PN 500	4	2.5	19	12	34.5	26	12	14	4.8	1162032058	24-SWOL-L6-P
L 8	PN 500	6	4	21	14	37.5	27.5	14	17	7.0	1162082058	24-SWOL-L8-P
L 10	PN 500	8	6	22	15	40	29	14	19	9.6	1162132058	24-SWOL-L10
L 12	PN 400	10	8	24	17	42	29.5	19	22	12.0	1162182058	24-SWOL-L12-P
L 15	PN 400	12	10	28	21	46	32.5	19	27	15.4	1162232058	24-SWOL-L15
L 18	PN 400	15	13	31	23.5	50	35.5	24	32	21.3	1162282058	24-SWOL-L18
L 22	PN 250	19	17	35	27.5	55	38.5	27	36	28.1	1162332058	24-SWOL-L22
L 28	PN 250	24	22	38	30.5	59	41.5	36	41	39.2	1162382058	24-SWOL-L28
L 35	PN 250	30	28	45	34.5	68.5	51	41	50	67.7	1162432058	24-SWOL-L35
L 42	PN 250	36	34	51	40	75	56	50	60	112.4	1162482058	24-SWOL-L42
S 6	PN 800	4	2.5	23	16	40	27	12	17	7.8	1162532058	24-SWOL-S6
S 8	PN 800	5	4	24	17	42.5	27.5	17	19	10.2	1162582058	24-SWOL-S8-P
S 10	PN 800	7	6	25	17.5	45	30	19	22	14.0	1162632058	24-SWOL-S10-P
S 12	PN 630	8	8	29	21.5	48	31	17	24	13.3	1162682058	24-SWOL-S12
S 14	PN 630	10	9	30	22	54	35	19	27	18.0	1162732058	24-SWOL-S14
S 16	PN 630	12	11	33	24.5	55	36.5	24	30	22.6	1162782058	24-SWOL-S16
S 20	PN 420	16	14	37	26.5	65	44.5	27	36	35.3	1162832058	24-SWOL-S20
S 25	PN 420	20	18	42	30	73	50	36	46	62.8	1162882058	24-SWOL-S25
S 30	PN 420	25	23	49	35.5	78.5	55	41	50	91.7	1162932058	24-SWOL-S30
S 38	PN 420	32	30	57	41	89	63	50	60	149.3	1162982058	24-SWOL-S38

Example for comp. :
 EL06LVITOMD
 ISO 8434-1-SWOBT-L6-St

Straight stud standpipe adapters

With taper and O-ring
fit in bore type W DIN 3861 / ISO 8434-1

Male thread: metric fine thread, parallel

Sealing with PEFLEX profile seal ring

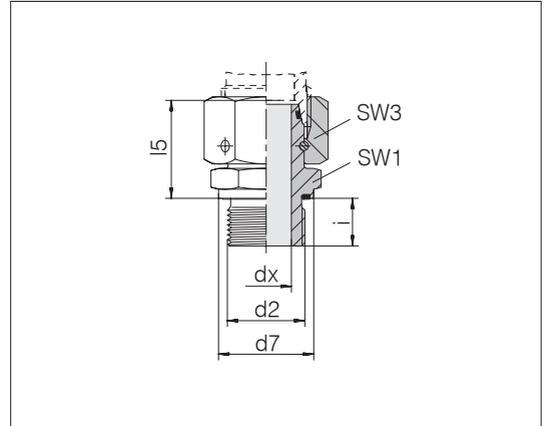

Series Tube OD	d2	Pressure	d7	dx	l5	SW1	SW3	i	Nm -10 %	kg/100 ca.	Order-No.	Designation
L 6	M 8 x 1	PN 500	11.9	2.5	24.5	12	14	8	12	2.2	1198052000	24-SWOSDS-L6-M8E
L 6	M 10 x 1	PN 500	13.9	2.5	24.5	14	14	8	15	2.6	1164032000	24-SWOSDS-L6-M10E •
L 8	M 12 x 1.5	PN 500	16.9	4.5	26.5	17	17	12	25	4.4	1164082000	24-SWOSDS-L8-M12E •
L 10	M 12 x 1.5	PN 500	16.9	6	26.5	17	19	12	25	4.8	1196012000	24-SWOSDS-L10-M12E
L 10	M 14 x 1.5	PN 500	18.9	6	27.5	19	19	12	50	5.7	1164132000	24-SWOSDS-L10-M14E •
L 10	M 16 x 1.5	PN 400	21.9	6	30.5	22	19	12	70	4.0	1197002000	24-SWOSDS-L10-M16E
L 12	M 16 x 1.5	PN 400	21.9	8	30.5	22	22	12	70	8.3	1164182000	24-SWOSDS-L12-M16E •
L 12	M 18 x 1.5	PN 400	23.9	8	30.5	24	22	12	90	10.3	1198202000	24-SWOSDS-L12-M18E
L 12	M 22 x 1.5	PN 400	26.9	8	30.5	27	22	14	130	11.1	1198712000	24-SWOSDS-L12-M22E
L 15	M 18 x 1.5	PN 400	23.9	10	31.5	24	27	12	90	11.9	1164232000	24-SWOSDS-L15-M18E •
L 15	M 22 x 1.5	PN 400	26.9	10	32.5	27	27	14	130	13.2	1198702000	24-SWOSDS-L15-M22E
L 18	M 22 x 1.5	PN 400	26.9	13	31.5	27	32	14	130	15.3	1164282000	24-SWOSDS-L18-M22E •
L 18	M 26 x 1.5	PN 250	31.9	13	31.5	32	32	16	180	19.5	1197502000	24-SWOSDS-L18-M26E
L 22	M 26 x 1.5	PN 250	31.9	17	32.5	32	36	16	180	20.2	1164332000	24-SWOSDS-L22-M26E •
L 28	M 33 x 2	PN 250	39.9	22	35	41	41	18	230	28.6	1164382000	24-SWOSDS-L28-M33E •
L 35	M 42 x 2	PN 250	49.9	28	42.5	50	50	20	330	50.0	1164432000	24-SWOSDS-L35-M42E •
L 42	M 48 x 2	PN 250	54.9	34	46.5	55	60	22	500	71.6	1164482000	24-SWOSDS-L42-M48E •
S 6	M 12 x 1.5	PN 800	16.9	2.5	27	17	17	12	50	4.7	1164532000	24-SWOSDS-S6-M12E •
S 6	M 16 x 1.5	PN 800	21.9	2.5	32	22	17	12	80	8.1	1196282000	24-SWOSDS-S6-M16E
S 8	M 14 x 1.5	PN 800	18.9	4	29.5	19	19	12	60	6.4	1164582000	24-SWOSDS-S8-M14E •
S 8	M 16 x 1.5	PN 800	21.9	4	32	22	19	12	60	8.6	1196292000	24-SWOSDS-S8-M16E
S 10	M 16 x 1.5	PN 800	21.9	6	32	22	22	12	80	9.0	1164632000	24-SWOSDS-S10-M16E •
S 12	M 16 x 1.5	PN 800	21.9	6	33	22	24	12	90	10.1	1196222000	24-SWOSDS-S12-M16E
S 12	M 18 x 1.5	PN 630	23.9	8	34	24	24	12	90	11.1	1164682000	24-SWOSDS-S12-M18E •
S 14	M 20 x 1.5	PN 630	25.9	9	36.5	27	27	14	130	15.7	1164732000	24-SWOSDS-S14-M20E •
S 16	M 22 x 1.5	PN 630	26.9	11	37	27	30	14	130	17.6	1164782000	24-SWOSDS-S16-M22E •
S 20	M 27 x 2	PN 420	31.9	14	43	32	36	16	200	27.6	1164832000	24-SWOSDS-S20-M27E •
S 25	M 33 x 2	PN 420	39.9	18	48	41	46	18	250	50.5	1164882000	24-SWOSDS-S25-M33E •
S 30	M 42 x 2	PN 420	49.9	23	51	50	50	20	500	69.7	1164932000	24-SWOSDS-S30-M42E •
S 38	M 48 x 2	PN 420	54.9	30	60	55	60	22	600	76.4	1164982000	24-SWOSDS-S38-M48E •

• Standard size

Example for comp. :
EGE06LMED
ISO 8434-1-SWOSDS-L6xM10x1-E-St



Straight stud standpipe adapters

With taper and O-ring
fit in bore type W DIN 3861 / ISO 8434-1

Male thread: Whitworth pipe thread, parallel

Sealing with PEFLEX profile seal ring

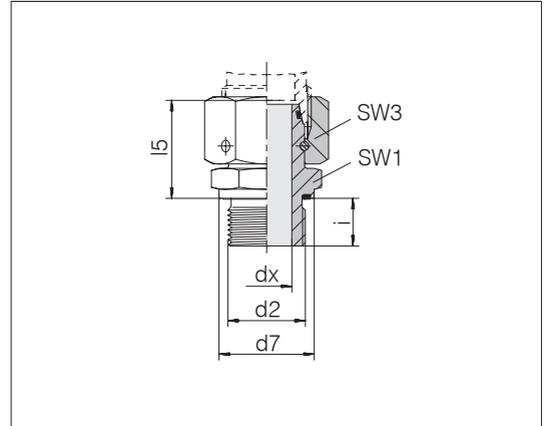

Series	d2	Pressure	d7	dx	l5	SW1	SW3	i	Nm -10 %	kg/100 ca.	Order-No.	Designation
L 6	G 1/8 A	PN 500	13.9	2.5	24.5	14	14	8	20	2.6	1165032000	24-SWOSDS-L6-G1/8E •
L 8	G 1/8 A	PN 500	13.9	4	24	14	17	8	20	3.3	1197392000	24-SWOSDS-L8-G1/8E
L 8	G 1/4 A	PN 500	18.9	4.5	29.5	19	17	12	50	5.7	1165082000	24-SWOSDS-L8-G1/4E •
L 10	G 1/4 A	PN 500	18.9	6	27.5	19	19	12	50	5.6	1165132000	24-SWOSDS-L10-G1/4E •
L 10	G 3/8 A	PN 400	21.9	6	28	22	19	12	80	7.3	1197212000	24-SWOSDS-L10-G3/8E
L 10	G 1/2 A	PN 400	26.9	6	28.5	27	19	14	100	9.8	1198302000	24-SWOSDS-L10-G1/2E
L 12	G 1/4 A	PN 500	18.9	6	27.5	19	22	12	50	6.9	1197572000	24-SWOSDS-L12-G1/4E
L 12	G 3/8 A	PN 400	21.9	8	34	22	22	12	80	9.6	1165182000	24-SWOSDS-L12-G3/8E •
L 12	G 1/2 A	PN 400	26.9	8	32	27	22	14	100	11.8	1198402000	24-SWOSDS-L12-G1/2E
L 15	G 3/8 A	PN 400	21.9	9	32.5	22	27	12	80	11.6	1198562000	24-SWOSDS-L15-G3/8E
L 15	G 1/2 A	PN 400	26.9	10	32	27	27	14	100	14.1	1165232000	24-SWOSDS-L15-G1/2E •
L 15	G 3/4 A	PN 250	31.9	10	30.5	32	27	14	100	15.4	1197032000	24-SWOSDS-L15-G3/4E
L 18	G 1/2 A	PN 400	26.9	13	31.5	27	32	14	100	14.4	1165282000	24-SWOSDS-L18-G1/2E •
L 18	G 3/4 A	PN 250	31.9	13	31	32	32	16	180	17.2	1198652000	24-SWOSDS-L18-G3/4E
L 22	G 1/2 A	PN 250	26.9	14	32	27	36	14	100	17.1	1198662000	24-SWOSDS-L22-G1/2E
L 22	G 3/4 A	PN 250	31.9	17	32.5	32	36	16	180	20.1	1165332000	24-SWOSDS-L22-G3/4E •
L 28	G 3/4 A	PN 250	31.9	17	35	32	41	16	180	23.5	1197012000	24-SWOSDS-L28-G3/4E
L 28	G 1 A	PN 250	39.9	22	35	41	41	18	230	29.3	1165382000	24-SWOSDS-L28-G1E •
L 35	G 1 1/4 A	PN 250	49.9	28	42.5	50	50	20	330	50.9	1165432000	24-SWOSDS-L35-G11/4E •
L 42	G 1 1/2 A	PN 250	54.9	34	46.5	55	60	22	500	72.2	1165482000	24-SWOSDS-L42-G11/2E •

• Standard size

Example for comp. :
EGE06LRED
ISO 8434-1-SWOSDS-L6x1/8A-E-St

Continued on following page

Straight stud standpipe adapters

With taper and O-ring
fit in bore type W DIN 3861 / ISO 8434-1

Male thread: Whitworth pipe thread, parallel

Sealing with PEFLEX profile seal ring

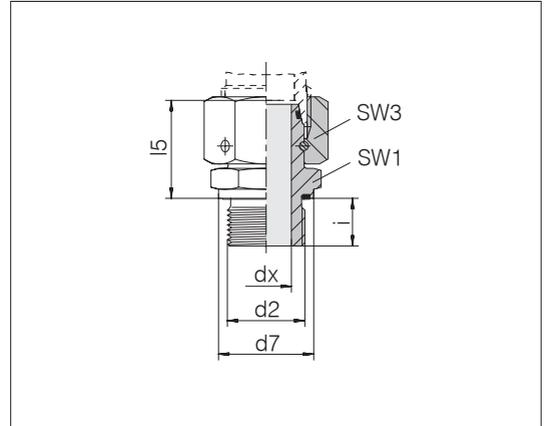

Series Tube OD	d2	Pressure	d7	dx	l5	SW1	SW3	i	Nm -10 %	kg/100 ca.	Order-No.	Designation
S 6	G 1/4 A	PN 800	18.9	2.5	27	19	17	12	60	5.4	1165532000	24-SWOSDS-S6-G1/4E •
S 8	G 1/4 A	PN 800	18.9	4	29.5	19	19	12	60	6.4	1165582000	24-SWOSDS-S8-G1/4E •
S 10	G 1/4 A	PN 800	18.9	5	32	19	22	12	60	8.7	1197512000	24-SWOSDS-S10-G1/4E •
S 10	G 3/8 A	PN 800	21.9	6	32	22	22	12	90	9.4	1165632000	24-SWOSDS-S10-G3/8E •
S 12	G 1/4 A	PN 630	18.9	5	30	19	24	12	60	7.9	1198582000	24-SWOSDS-S12-G1/4E •
S 12	G 3/8 A	PN 630	21.9	8	34	22	24	12	90	10.0	1165682000	24-SWOSDS-S12-G3/8E •
S 12	G 1/2 A	PN 630	26.9	8	35.5	27	24	14	150	14.4	1198572000	24-SWOSDS-S12-G1/2E •
S 14	G 1/2 A	PN 630	26.9	9	36.5	27	27	14	150	16.4	1165732000	24-SWOSDS-S14-G1/2E •
S 16	G 1/2 A	PN 630	26.9	11	37	27	30	14	150	17.1	1165782000	24-SWOSDS-S16-G1/2E •
S 16	G 3/4 A	PN 420	31.9	11	39.5	32	30	16	200	24.4	1197772000	24-SWOSDS-S16-G3/4E •
S 20	G 1/2 A	PN 420	26.9	12	43	27	36	14	150	21.2	1198312000	24-SWOSDS-S20-G1/2E •
S 20	G 3/4 A	PN 420	31.9	14	43	32	36	16	200	27.2	1165832000	24-SWOSDS-S20-G3/4E •
S 25	G 3/4 A	PN 420	31.9	16	48	32	46	16	200	39.7	1196482000	24-SWOSDS-S25-G3/4E •
S 25	G 1 A	PN 420	39.9	18	48	41	46	18	250	50.6	1165882000	24-SWOSDS-S25-G1E •
S 30	G 1 A	PN 420	39.9	18	51.5	41	50	18	250	54.4	1197412000	24-SWOSDS-S30-G1E •
S 30	G 1 1/4 A	PN 420	49.9	23	51	50	50	20	500	68.5	1165932000	24-SWOSDS-S30-G11/4E •
S 38	G 1 1/4 A	PN 420	49.9	25	54.5	50	60	22	600	78.9	1197362000	24-SWOSDS-S38-G11/4E •
S 38	G 1 1/2 A	PN 420	54.9	30	60	55	60	22	600	95.5	1165982000	24-SWOSDS-S38-G11/2E •

• Standard size



Reducing couplings

With taper and O-ring
fit in bore type W DIN 3861 / ISO 8434-1

Standard O-ring material is FPM/FKM

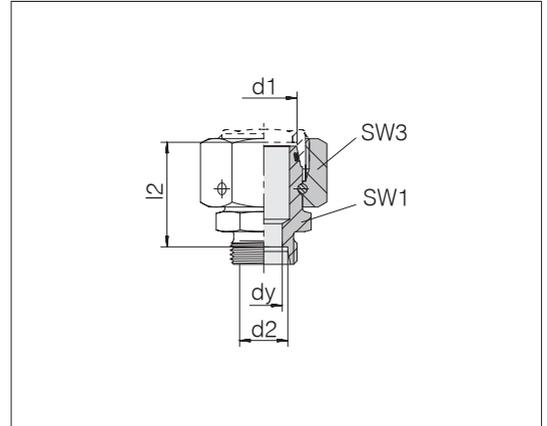

Series	Tube OD	Series	Tube OD	Pressure	dy	l2	SW1	SW3	kg/100 ca.	Order-No.	Designation
d1	d2										
L	8	L	6	PN 500	4	23.5	12	17	2.9	1181002058	24-SWOS-L8-L6
L	10	L	6	PN 500	4	25	14	19	3.8	1181012058	24-SWOS-L10-L6
L	10	L	8	PN 500	6	25	14	19	3.8	1181022058	24-SWOS-L10-L8
L	10	S	8	PN 500	5	28	17	19	4.9	1181962058	24-SWOS-L10-S8
L	12	L	6	PN 400	4	25	17	22	5.0	1181032058	24-SWOS-L12-L6
L	12	L	8	PN 400	6	25	17	22	5.1	1181042058	24-SWOS-L12-L8
L	12	L	10	PN 400	8	26	17	22	5.2	1181052058	24-SWOS-L12-L10
L	12	S	6	PN 400	4	28	17	22	5.6	1181952058	24-SWOS-L12-S6
L	12	S	8	PN 400	5	28	17	22	6.0	1181982058	24-SWOS-L12-S8
L	15	L	6	PN 400	4	28	19	27	8.7	1181062058	24-SWOS-L15-L6
L	15	L	8	PN 400	6	28	19	27	8.8	1181072058	24-SWOS-L15-L8
L	15	L	10	PN 400	8	29	19	27	8.9	1181082058	24-SWOS-L15-L10
L	15	L	12	PN 400	10	29	19	27	9.0	1181092058	24-SWOS-L15-L12
L	15	L	18	PN 400	10	31	27	27	11.8	1181942058	24-SWOS-L15-L18
L	15	S	8	PN 400	5	30	19	27	9.4	1181992058	24-SWOS-L15-S8
L	18	L	6	PN 400	4	28	24	32	11.1	1181102058	24-SWOS-L18-L6
L	18	L	8	PN 400	6	28	24	32	11.1	1181112058	24-SWOS-L18-L8
L	18	L	10	PN 400	8	29	24	32	11.2	1181122058	24-SWOS-L18-L10
L	18	L	12	PN 400	10	29	24	32	11.3	1181132058	24-SWOS-L18-L12
L	18	L	15	PN 400	12	30	24	32	11.8	1181142058	24-SWOS-L18-L15
L	18	S	8	PN 400	5	30	24	32	11.6	1181972058	24-SWOS-L18-S8
L	22	L	6	PN 250	4	32	27	36	15.4	1181152058	24-SWOS-L22-L6
L	22	L	8	PN 250	6	32	27	36	15.5	1181162058	24-SWOS-L22-L8
L	22	L	10	PN 250	8	33	27	36	15.7	1181172058	24-SWOS-L22-L10
L	22	L	12	PN 250	10	33	27	36	16.1	1181182058	24-SWOS-L22-L12
L	22	L	15	PN 250	12	34	27	36	16.2	1181192058	24-SWOS-L22-L15
L	22	L	18	PN 250	15	33.5	27	36	16.6	1181202058	24-SWOS-L22-L18
L	28	L	8	PN 250	6	34	32	41	20.1	1181222058	24-SWOS-L28-L8
L	28	L	10	PN 250	8	35	32	41	20.1	1181232058	24-SWOS-L28-L10
L	28	L	12	PN 250	10	35	32	41	20.1	1181242058	24-SWOS-L28-L12
L	28	L	15	PN 250	12	36	32	41	20.6	1181252058	24-SWOS-L28-L15

Reducing couplings

With taper and O-ring
fit in bore type W DIN 3861 / ISO 8434-1

Standard O-ring material is FPM/FKM

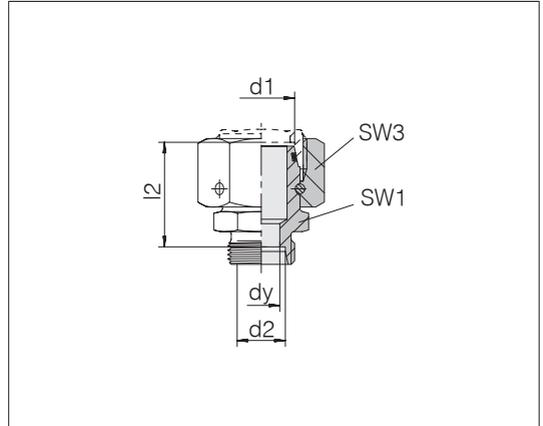

Series Tube OD d1	Series Tube OD d2	Pressure	dy	l2	SW1	SW3	kg/100 ca.	Order-No.	Designation
L 28	L 18	PN 250	15	35.5	32	41	21.0	1181262058	24-SWOS-L28-L18
L 28	L 22	PN 250	19	37.5	32	41	21.0	1181272058	24-SWOS-L28-L22
L 28	S 16	PN 250	12	36.5	32	41	21.5	1181922058	24-SWOS-L28-S16
L 28	S 20	PN 250	16	36.5	32	41	23.2	1181912058	24-SWOS-L28-S20
L 35	L 6	PN 250	4	37	41	50	31.9	1181282058	24-SWOS-L35-L6
L 35	L 8	PN 250	6	37	41	50	30.6	1181292058	24-SWOS-L35-L8
L 35	L 10	PN 250	8	38	41	50	32.3	1181302058	24-SWOS-L35-L10
L 35	L 12	PN 250	10	38	41	50	31.3	1181312058	24-SWOS-L35-L12
L 35	L 15	PN 250	12	39	41	50	31.6	1181322058	24-SWOS-L35-L15
L 35	L 18	PN 250	15	38.5	41	50	31.9	1181332058	24-SWOS-L35-L18
L 35	L 22	PN 250	19	40.5	41	50	32.1	1181342058	24-SWOS-L35-L22
L 35	L 28	PN 250	24	40.5	41	50	32.3	1181352058	24-SWOS-L35-L28
L 42	L 6	PN 250	4	40.5	50	60	52.5	1181812058	24-SWOS-L42-L6
L 42	L 8	PN 250	6	40.5	50	60	51.9	1181362058	24-SWOS-L42-L8
L 42	L 10	PN 250	8	41.5	50	60	52.8	1181372058	24-SWOS-L42-L10
L 42	L 12	PN 250	10	41.5	50	60	51.8	1181382058	24-SWOS-L42-L12
L 42	L 15	PN 250	12	42.5	50	60	53.4	1181392058	24-SWOS-L42-L15
L 42	L 18	PN 250	15	42	50	60	52.7	1181412058	24-SWOS-L42-L18
L 42	L 22	PN 250	19	44	50	60	51.5	1181422058	24-SWOS-L42-L22
L 42	L 28	PN 250	24	44	50	60	51.5	1181432058	24-SWOS-L42-L28
L 42	L 35	PN 250	30	43	50	60	53.1	1181442058	24-SWOS-L42-L35

Continued on following page



Reducing couplings

With taper and O-ring
fit in bore type W DIN 3861 / ISO 8434-1

Standard O-ring material is FPM/FKM

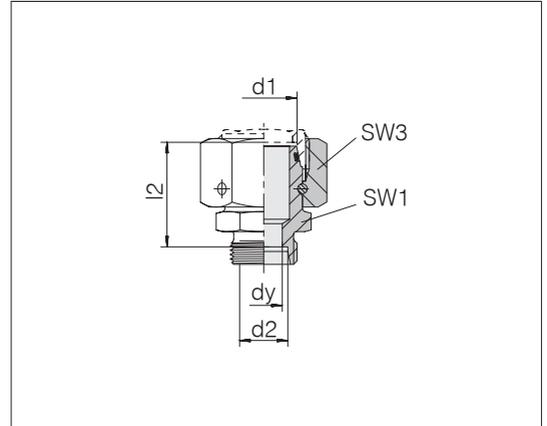

Series	Tube OD	Series	Tube OD	Pressure	dy	l2	SW1	SW3	kg/100 ca.	Order-No.	Designation
d1	d2										
S	8	S	6	PN 800	4	27	14	19	4.3	1181452058	24-SWOS-S8-S6
S	10	S	6	PN 800	4	27.5	17	22	5.5	1181462058	24-SWOS-S10-S6
S	10	S	8	PN 800	5	27.5	17	22	5.7	1181472058	24-SWOS-S10-S8
S	12	S	6	PN 630	4	30	19	24	7.0	1181482058	24-SWOS-S12-S6
S	12	S	8	PN 630	5	30	19	24	7.1	1181492058	24-SWOS-S12-S8
S	12	S	10	PN 630	7	29.5	19	24	7.3	1181502058	24-SWOS-S12-S10
S	14	S	6	PN 630	4	31.5	19	27	9.4	1181512058	24-SWOS-S14-S6
S	14	S	8	PN 630	5	31.5	19	27	9.5	1181522058	24-SWOS-S14-S8
S	14	S	10	PN 630	7	31	22	27	10.2	1181532058	24-SWOS-S14-S10
S	14	S	12	PN 630	8	31	22	27	10.4	1181542058	24-SWOS-S14-S12
S	16	L	12	PN 400	10	32	22	30	11.6	1181932058	24-SWOS-S16-L12
S	16	L	15	PN 400	11	38.8	24	30	14.4	1198602058	24-SWOS-S16-L15
S	16	S	6	PN 630	4	32	22	30	11.4	1181552058	24-SWOS-S16-S6
S	16	S	8	PN 630	5	32	22	30	11.6	1181562058	24-SWOS-S16-S8
S	16	S	10	PN 630	7	31.5	22	30	11.7	1181572058	24-SWOS-S16-S10
S	16	S	12	PN 630	8	31.5	22	30	12.0	1181582058	24-SWOS-S16-S12
S	16	S	14	PN 630	10	31.5	24	30	12.8	1181592058	24-SWOS-S16-S14
S	20	L	15	PN 400	12	36	27	36	16.6	1197582058	24-SWOS-S20-L15
S	20	S	6	PN 420	4	36	27	36	17.0	1181602058	24-SWOS-S20-S6
S	20	S	8	PN 420	5	36	27	36	17.2	1181612058	24-SWOS-S20-S8
S	20	S	10	PN 420	7	35.5	27	36	17.0	1181622058	24-SWOS-S20-S10
S	20	S	12	PN 420	8	35.5	27	36	17.3	1181632058	24-SWOS-S20-S12
S	20	S	16	PN 420	12	36.5	27	36	17.9	1181652058	24-SWOS-S20-S16
S	25	L	18	PN 400	15	38	32	46	31.5	1198612058	24-SWOS-S25-L18
S	25	S	6	PN 420	4	38.5	32	46	30.9	1181662058	24-SWOS-S25-S6
S	25	S	8	PN 420	5	38.5	32	46	30.9	1181672058	24-SWOS-S25-S8
S	25	S	10	PN 420	7	38	32	46	31.2	1181682058	24-SWOS-S25-S10
S	25	S	12	PN 420	8	38	32	46	31.3	1181692058	24-SWOS-S25-S12
S	25	S	16	PN 420	12	39	32	46	31.7	1181712058	24-SWOS-S25-S16
S	25	S	20	PN 420	16	39	32	46	32.8	1181722058	24-SWOS-S25-S20
S	30	L	22	PN 250	19	45.5	41	50	40.9	1198072058	24-SWOS-S30-L22
S	30	S	6	PN 420	4	44	41	50	40.4	1181732058	24-SWOS-S30-S6
S	30	S	8	PN 420	5	44	41	50	39.9	1181742058	24-SWOS-S30-S8

Continued on following page

Reducing couplings

With taper and O-ring
fit in bore type W DIN 3861 / ISO 8434-1

Standard O-ring material is FPM/FKM

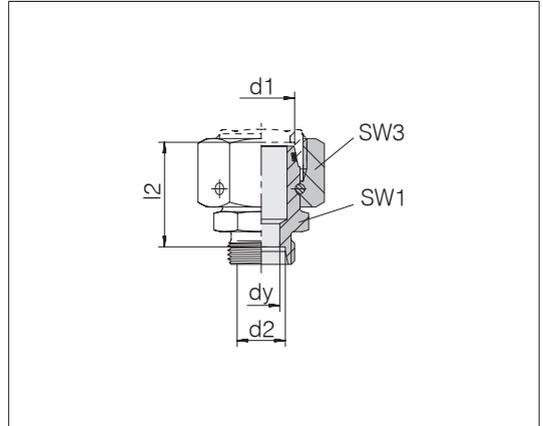

Series Tube OD d_1	Series Tube OD d_2	Pressure	d_y	l_2	SW1	SW3	kg/100 ca.	Order-No.	Designation
S 30	S 10	PN 420	7	43.5	41	50	40.4	1181752058	24-SWOS-S30-S10
S 30	S 12	PN 420	8	43.5	41	50	40.5	1181762058	24-SWOS-S30-S12
S 30	S 16	PN 420	12	44.5	41	50	40.6	1181782058	24-SWOS-S30-S16
S 30	S 20	PN 420	16	44.5	41	50	42.2	1181792058	24-SWOS-S30-S20
S 30	S 25	PN 420	20	45	41	50	44.8	1181802058	24-SWOS-S30-S25
S 38	S 6	PN 420	4	47.5	50	60	57.6	1181822058	24-SWOS-S38-S6
S 38	S 8	PN 420	5	47.5	50	60	57.8	1181832058	24-SWOS-S38-S8
S 38	S 10	PN 420	7	47	50	60	58.4	1181842058	24-SWOS-S38-S10
S 38	S 12	PN 420	8	47	50	60	59.2	1181852058	24-SWOS-S38-S12
S 38	S 16	PN 420	12	48	50	60	59.2	1181862058	24-SWOS-S38-S16
S 38	S 20	PN 420	16	48	50	60	59.7	1181872058	24-SWOS-S38-S20
S 38	S 25	PN 420	20	48.5	50	60	62.3	1181882058	24-SWOS-S38-S25
S 38	S 30	PN 420	25	49	50	60	63.6	1181892058	24-SWOS-S38-S30

Distance adapters

With taper and O-ring

Standard O-ring material is FPM/FKM

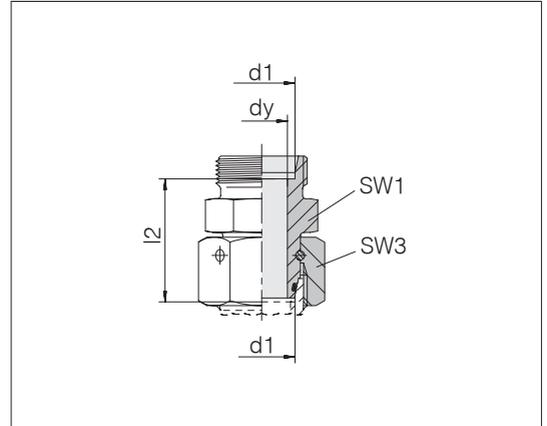

Series	Tube OD	Pressure	dy	l2	SW1	SW3	Nm -5 %	kg/100 ca.	Order-No.	Designation
L	6	PN 500	2.5	36	12	14	20	3.7	1191402058	24-SWOS-L6
L	8	PN 500	4	36	14	17	30	5.0	1191412058	24-SWOS-L8
L	10	PN 500	6	36	17	19	40	6.6	1191422058	24-SWOS-L10
L	12	PN 400	8	36	19	22	50	8.7	1191862058	24-SWOS-L12
L	15	PN 400	10	36	24	27	70	13.2	1191432058	24-SWOS-L15
L	18	PN 400	13	36	27	32	90	16.8	1191882058	24-SWOS-L18
L	22	PN 250	17	40	32	36	120	23.0	1191872058	24-SWOS-L22
L	28	PN 250	22	40	41	41	160	29.7	1191892058	24-SWOS-L28
L	35	PN 250	28	50	46	50	250	49.0	1191902058	24-SWOS-L35
L	42	PN 250	34	60	55	60	380	85.0	1191912058	24-SWOS-L42
S	6	PN 800	2.5	36	14	17	25	5.3	1191442058	24-SWOS-S6
S	8	PN 800	4	36	17	19	40	7.0	1191492058	24-SWOS-S8
S	10	PN 800	6	36	19	22	50	8.7	1191522058	24-SWOS-S10
S	12	PN 630	8	36	22	24	60	10.4	1191482058	24-SWOS-S12
S	14	PN 630	9	40	24	27	75	14.7	1191532058	24-SWOS-S14
S	16	PN 630	11	40	27	30	85	17.8	1191542058	24-SWOS-S16
S	20	PN 420	14	46	32	36	140	28.0	1191512058	24-SWOS-S20
S	25	PN 420	18	50	41	46	190	50.3	1191502058	24-SWOS-S25
S	30	PN 420	23	56	46	50	270	65.6	1191342058	24-SWOS-S30
S	38	PN 420	30	60	55	60	400	93.6	1191692058	24-SWOS-S38

Example for comp. :
DA06LOMDCF

Adjustable couplings with lock nut

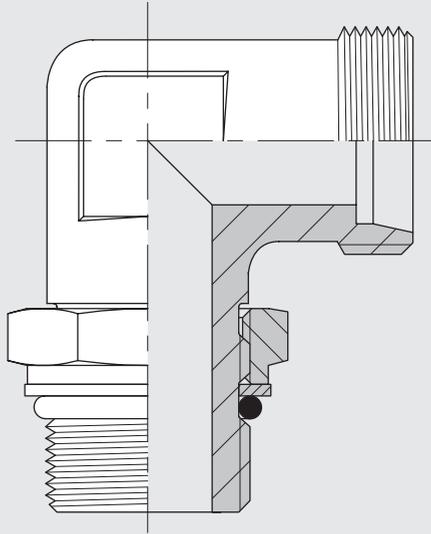

Adjustable elbow couplings with lock nut

Male thread: metric fine thread, parallel

Sealing with PEFLEX profile seal ring

Standard profile seal ring and O-ring material (internal sealing) is NBR

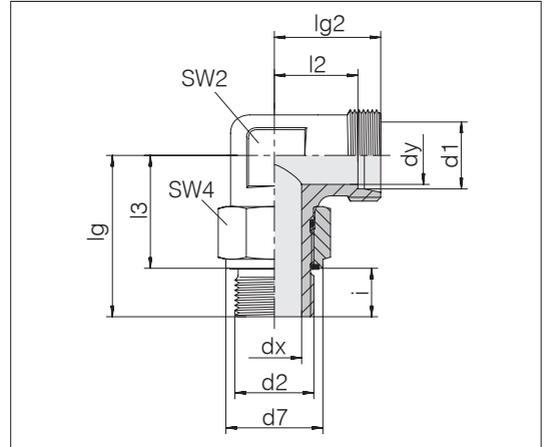

Series	d2	Pressure	d7	dx	dy	lg	lg2	l2	l3	SW2	SW4	i	Nm -10 %	kg/100 ca.	Order-No.	Designation		
Tube OD d1																		
L	6	M 10 x 1	PN 315	13.9	4.5	4	29.5	21	14	21.5	14	14	8	18	4.4	1113002081	24-SDAE-L6-M10E	•
L	6	M 12 x 1.5	PN 315	16.9	6	4	36.5	21	14	24.5	14	17	12	35	5.8	1113012081	24-SDAE-L6-M12E	•
L	6	M 14 x 1.5	PN 315	18.9	7	4	39	23	16	27	17	19	12	55	8.1	1113022081	24-SDAE-L6-M14E	•
L	8	M 12 x 1.5	PN 315	16.9	6	6	36.5	23	16	24.5	14	17	12	35	6.1	1113052081	24-SDAE-L8-M12E	•
L	10	M 14 x 1.5	PN 315	18.9	7.5	8	39	24	17	27	17	19	12	55	7.4	1113102081	24-SDAE-L10-M14E	•
L	10	M 18 x 1.5	PN 315	23.9	11	8	42	28	28	30	22	19	11.9	90	13.6	1113112081	24-SDAE-L10-M18E	•
L	12	M 16 x 1.5	PN 315	21.9	9	10	40	24	17	28	17	22	12	80	9.6	1113152081	24-SDAE-L12-M16E	•
L	12	M 18 x 1.5	PN 315	23.9	11	10	32	28	21	30	22	24	12	90	14.6	1113162081	24-SDAE-L12-M18E	•
L	15	M 18 x 1.5	PN 315	23.9	11	12	32	28	21	30	22	24	12	90	13.7	1113202081	24-SDAE-L15-M18E	•
L	15	M 22 x 1.5	PN 315	26.9	14	12	46	29	22	32	22	27	14	130	16.4	1113212081	24-SDAE-L15-M22E	•
L	18	M 18 x 1.5	PN 315	23.9	11	15	46	31	23.5	34	24	24	12	90	16.1	1113262081	24-SDAE-L18-M18E	•
L	18	M 22 x 1.5	PN 315	26.9	14	15	49.5	33	25.5	35.5	27	27	14	130	24.6	1113252081	24-SDAE-L18-M22E	•
L	18	M 26 x 1.5	PN 160	31.9	18	15	53	33	25.5	37	27	32	16	180	27.0	1113272081	24-SDAE-L18-M26E	•
L	22	M 26 x 1.5	PN 160	31.9	18	19	53	35	27.5	37	27	32	16	180	24.2	1113312081	24-SDAE-L22-M26E	•
L	22	M 27 x 2	PN 160	31.9	18	19	56	35	27.5	40	27	32	16	190	27.9	1113302081	24-SDAE-L22-M27E	•
L	28	M 26 x 1.5	PN 160	31.9	18	24	59	38	30.5	43	36	32	16	180	36.3	1113362081	24-SDAE-L28-M26E	•
L	28	M 33 x 2	PN 160	40.9	23	24	68.5	40	32.5	50.5	41	41	18	250	65.9	1113352081	24-SDAE-L28-M33E	•
L	35	M 42 x 2	PN 160	49.9	30	30	75.5	46.5	36	55.5	50	50	20	350	103.9	1113402081	24-SDAE-L35-M42E	•
L	42	M 48 x 2	PN 160	54.9	36	36	79.5	51	40	57.5	50	55	22	500	106.4	1113452081	24-SDAE-L42-M48E	•
S	6	M 12 x 1.5	PN 315	16.9	4	4	36.5	23.5	16.5	24.5	14	17	12	35	6.9	1113502081	24-SDAE-S6-M12E	•
S	8	M 14 x 1.5	PN 315	18.9	6	5	39	25	18	27	17	19	12	55	9.2	1113552081	24-SDAE-S8-M14E	•
S	10	M 12 x 1.5	PN 315	16.9	6	7	38.5	25	17.5	26.5	17	17	12	35	7.9	1113612081	24-SDAE-S10-M12E	•
S	10	M 16 x 1.5	PN 315	21.9	7	7	40	25	17.5	28	17	22	12	80	12.2	1113602081	24-SDAE-S10-M16E	•
S	12	M 18 x 1.5	PN 315	23.9	9	8	42	29	21.5	30	22	24	12	90	17.1	1113652081	24-SDAE-S12-M18E	•
S	16	M 22 x 1.5	PN 315	26.9	12	12	49.5	35	26.5	35.5	27	27	14	130	27.4	1113752081	24-SDAE-S16-M22E	•
S	20	M 27 x 2	PN 250	31.9	15	16	56	38	27.5	40	27	32	16	220	34.3	1113802081	24-SDAE-S20-M27E	•
S	25	M 33 x 2	PN 160	40.9	20	20	68.5	44	32	50.5	41	41	18	250	76.9	1113852081	24-SDAE-S25-M33E	•
S	30	M 42 x 2	PN 160	49.9	26	25	75.5	50	36.5	55.5	50	50	20	350	121.4	1113902081	24-SDAE-S30-M42E	•
S	38	M 48 x 2	PN 160	54.9	32	32	79.5	57	41	57.5	50	55	22	500	133.1	1113952081	24-SDAE-S38-M48E	•

• Standard size



Adjustable elbow couplings with lock nut

Male thread: Whitworth pipe thread, parallel

Sealing with PEFLEX profile seal ring

Standard profile seal ring and
O-ring material (internal sealing) is NBR

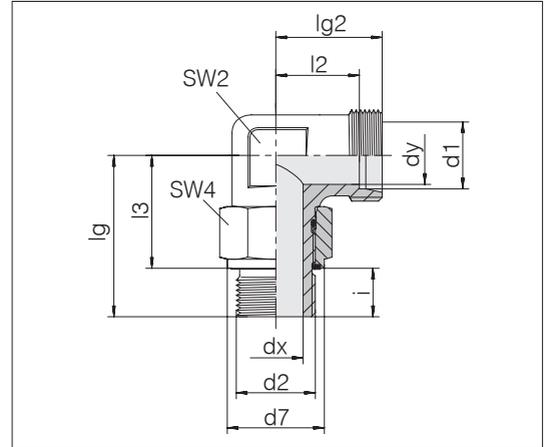

Series	d2	Pressure	d7	dx	dy	lg	lg2	l2	l3	SW2	SW4	i	Nm -10 %	kg/100 ca.	Order-No.	Designation	
L	6 G 1/8 A	PN 315	13.9	4	4	29	21	14	21	14	14	8	20	4.1	1144002081	24-SDAE-L6-G1/8E	•
L	6 G 1/4 A	PN 315	18.9	7	4	38	23	16	26	17	19	12	50	7.8	1144012081	24-SDAE-L6-G1/4E	•
L	8 G 1/4 A	PN 315	18.9	7	6	38	23	16	26	17	19	12	50	7.9	1144052081	24-SDAE-L8-G1/4E	•
L	8 G 3/8 A	PN 315	21.9	9	6	41	25	18	29	19	22	11.9	80	11.0	1144062081	24-SDAE-L8-G3/8E	•
L	10 G 1/4 A	PN 315	18.9	7	8	38	24	17	26	17	19	12	50	7.9	1144102081	24-SDAE-L10-G1/4E	•
L	12 G 1/4 A	PN 315	18.9	7	10	48	24	17	26	17	19	12	50	7.6	1144162081	24-SDAE-L12-G1/4E	•
L	12 G 3/8 A	PN 315	21.9	10	10	41	26	19	29	19	22	12	80	11.2	1144152081	24-SDAE-L12-G3/8E	•
L	12 G 1/2 A	PN 250	26.9	12.5	10	44	28	21	30	22	27	14	105	15.4	1144172081	24-SDAE-L12-G1/2E	•
L	15 G 1/2 A	PN 250	26.9	12.5	12	44	28	21	30	22	27	14	105	15.3	1144202081	24-SDAE-L15-G1/2E	•
L	18 G 1/2 A	PN 250	26.9	12.5	15	51	33	25.5	37	27	27	14	105	25.9	1144252081	24-SDAE-L18-G1/2E	•
L	18 G 3/4 A	PN 160	32.9	15.5	15	55	33	25.5	39	27	36	15.9	190	32.6	1144262081	24-SDAE-L18-G3/4E	•
L	22 G 1/2 A	PN 160	26.9	12.5	19	51	35	27.5	37	27	27	14	105	24.5	1144312081	24-SDAE-L22-G1/2E	•
L	22 G 3/4 A	PN 160	35.9	18	19	55	35	27.5	39	27	36	16	190	33.6	1144302081	24-SDAE-L22-G3/4E	•
L	28 G 3/4 A	PN 160	35.9	15.5	24	60.5	38	30.5	44.5	36	36	16	190	43.7	1144362081	24-SDAE-L28-G3/4E	•
L	28 G 1 A	PN 160	40.9	21.5	24	68.5	40	32.5	50.5	41	41	18	250	70.5	1144352081	24-SDAE-L28-G1E	•
L	35 G 1 1/4 A	PN 160	49.9	27.5	30	76	46.5	36	56	50	50	20	400	111.5	1144402081	24-SDAE-L35-G1 1/4E	•
L	42 G 1 1/2 A	PN 160	54.9	33	36	79.5	51	40	57.5	50	55	22	500	115.4	1144452081	24-SDAE-L42-G1 1/2E	•
S	6 G 1/4 A	PN 315	18.9	6	4	38	25	18	26	17	19	12	50	8.7	1144502081	24-SDAE-S6-G1/4E	•
S	8 G 1/4 A	PN 315	18.9	7	5	38	25	18	26	17	19	12	50	8.5	1144552081	24-SDAE-S8-G1/4E	•
S	10 G 3/8 A	PN 315	21.9	10	7	41	27	19.5	29	19	22	12	80	12.1	1144602081	24-SDAE-S10-G3/8E	•
S	12 G 3/8 A	PN 315	21.9	10	8	41	29	21.5	29	19	22	12	80	12.1	1144652081	24-SDAE-S12-G3/8E	•
S	14 G 1/2 A	PN 315	26.9	10	10	44	30	22	30	24	27	14	110	19.3	1144702081	24-SDAE-S14-G1/2E	•
S	16 G 1/2 A	PN 315	26.9	10	12	51	35	26.5	37	27	27	14	110	27.3	1144752081	24-SDAE-S16-G1/2E	•
S	16 G 3/4 A	PN 250	35.9	15.5	12	55	35	26.5	39	27	36	16	220	35.3	1144762081	24-SDAE-S16-G3/4E	•
S	20 G 3/4 A	PN 250	35.9	15.5	16	55	38	27.5	39	27	36	16	220	36.2	1144802081	24-SDAE-S20-G3/4E	•
S	25 G 3/4 A	PN 250	35.9	15.5	20	60.5	42	30	44.5	36	36	16	220	46.5	1144862081	24-SDAE-S25-G3/4E	•
S	25 G 1 A	PN 250	40.9	21.5	20	68.5	44	32	50.5	41	41	18	280	75.0	1144852081	24-SDAE-S25-G1E	•
S	30 G 1 1/4 A	PN 160	49.9	27.5	25	76	50	36.5	56	50	50	20	400	118.7	1144902081	24-SDAE-S30-G1 1/4E	•
S	38 G 1 1/2 A	PN 160	54.9	33	32	79.5	57	41	57.5	50	55	22	500	129.5	1144952081	24-SDAE-S38-G1 1/2E	•

• Standard size

Adjustable elbow couplings with lock nut

Male thread: metric fine thread,
ISO 6149, parallel

Sealing with O-ring

Standard O-ring material is NBR

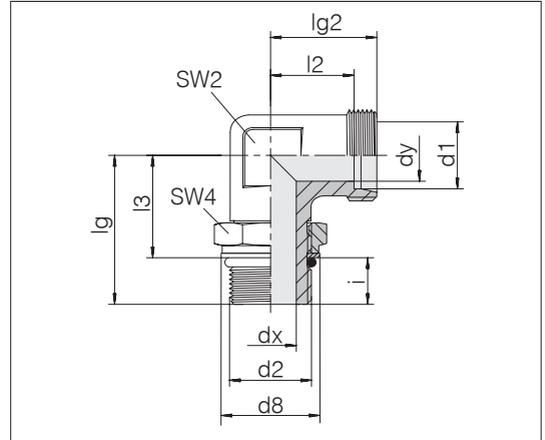

Series	d2	Pressure	d8	dx	dy	lg	lg2	l2	l3	SW2	SW4	i	Nm -10 %	kg/100 ca.	Order-No.	Designation		
Tube OD d1																		
L 6	M 10 x 1	PN 315	14.5	4.5	4	27	19	12	20	12	14	7	15	2.6	0147002081	24-SDAE-L6-M10F	•	
L 8	M 12 x 1.5	PN 315	17.5	6	6	32	21	14	22	12	17	10	25	3.7	0147052081	24-SDAE-L8-M12F	•	
L 10	M 12 x 1.5	PN 315	17.5	6	8	35	22	15	25	14	17	10	25	4.6	0147112081	24-SDAE-L10-M12F	•	
L 10	M 14 x 1.5	PN 315	19.5	7.5	8	35	22	15	25	14	19	10	35	4.8	0147102081	24-SDAE-L10-M14F	•	
L 10	M 18 x 1.5	PN 315	24.5	11	8	41	24	17	30	19	24	11	45	9.7	0147122081	24-SDAE-L10-M18F	•	
L 12	M 12 x 1.5	PN 315	17.5	6	10	36	24.5	17.5	26	17	17	10	25	5.4	0147172081	24-SDAE-L12-M12F	•	
L 12	M 16 x 1.5	PN 315	22.5	9	10	36	24	17	26	17	22	10	40	6.5	0147152081	24-SDAE-L12-M16F	•	
L 12	M 18 x 1.5	PN 315	24.5	11	26	41	26	19	30	19	24	11	45	10.0	0147182081	24-SDAE-L12-M18F	•	
L 15	M 18 x 1.5	PN 315	24.5	11	12	41	28	21	30	19	24	11	45	10.4	0147202081	24-SDAE-L15-M18F	•	
L 18	M 22 x 1.5	PN 315	27.5	14	15	45	31	23.5	33	24	27	12	60	15.7	0147252081	24-SDAE-L18-M22F	•	
L 22	M 27 x 2	PN 160	32.5	18	19	49	35	27.5	35	27	32	14	100	20.7	0147302081	24-SDAE-L22-M27F	•	
L 28	M 33 x 2	PN 160	41.5	23	24	52	38	30.5	38	36	41	14	160	34.5	0147352081	24-SDAE-L28-M33F	•	
L 35	M 42 x 2	PN 160	50.5	30	30	62	45	34.5	48	41	50	14	210	52.7	0147402081	24-SDAE-L35-M42F	•	
L 42	M 48 x 2	PN 160	55.5	36	36	65	51	40	49	50	55	16	260	81.3	0147452081	24-SDAE-L42-M48F	•	
S 6	M 12 x 1.5	PN 400	17.5	4	4	32	23	16	22	12	17	10	35	4.6	0147502081	24-SDAE-S6-M12F	•	
S 8	M 14 x 1.5	PN 400	19.5	6	5	36	24	17	26	14	19	10	45	6.4	0147552081	24-SDAE-S8-M14F	•	
S 10	M 16 x 1.5	PN 400	22.5	7	7	38	25	17.5	27	17	22	11	55	8.6	0147602081	24-SDAE-S10-M16F	•	
S 12	M 18 x 1.5	PN 400	24.5	9	8	43	29	21.5	31	17	24	12	70	11.6	0147652081	24-SDAE-S12-M18F	•	
S 16	M 22 x 1.5	PN 400	27.5	12	12	49	33	24.5	35	24	27	14	100	17.9	0147752081	24-SDAE-S16-M22F	•	
S 20	M 27 x 2	PN 400	32.5	15	16	55	37	26.5	39	27	32	16	170	28.7	0147802081	24-SDAE-S20-M27F	•	
S 25	M 33 x 2	PN 315	41.5	20	20	60	42	30	44	36	41	16	310	48.0	0147852081	24-SDAE-S25-M33F	•	
S 30	M 42 x 2	PN 250	50.5	26	25	68	49	35.5	51	41	50	17	330	76.5	0147902081	24-SDAE-S30-M42F	•	
S 38	M 48 x 2	PN 200	55.5	32	32	73	57	41	54	50	55	19	420	114.5	0147952081	24-SDAE-S38-M48F	•	

• Standard size

Example for comp. :
WEEO6LMOROMD



Adjustable 45° elbow couplings with lock nut

Male thread: metric fine thread,
ISO 6149, parallel

Sealing with O-ring

Standard O-ring material is NBR

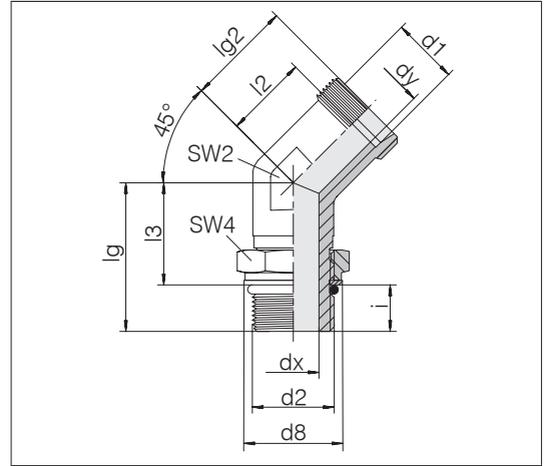

Series	d2	Pressure	d8	dx	dy	lg	lg2	l2	l3	SW2	SW4	i	Nm -10 %	kg/100 ca.	Order-No.	Designation
Tube OD d1																
L 6	M 10 x 1	PN 315	14.5	4.5	4	27	21	14	20	19	14	7	15	6.1	1145002081	24-SDAE45-L6-M10F
L 8	M 12 x 1.5	PN 315	17.5	6	6	32	23	16	22	19	17	10	25	7.1	1145052081	24-SDAE45-L8-M12F
L 10	M 14 x 1.5	PN 315	19.5	7.5	8	35	24	17	25	19	19	10	35	8.1	1145102081	24-SDAE45-L10-M14F
L 12	M 16 x 1.5	PN 315	22.5	9	10	36	26	19	26	19	22	10	40	8.7	1145152081	24-SDAE45-L12-M16F
L 15	M 18 x 1.5	PN 315	24.5	11	12	41	24	17	30	19	24	11	45	9.7	1145202081	24-SDAE45-L15-M18F
L 18	M 22 x 1.5	PN 315	27.5	14	15	45	26.5	19	33	24	27	12	60	17.7	1145252081	24-SDAE45-L18-M22F
L 22	M 27 x 2	PN 160	32.5	18	19	49	30	22.5	35	27	32	14	100	19.8	1145302081	24-SDAE45-L22-M27F
L 28	M 33 x 2	PN 160	41.5	23	24	52	32	24.5	38	36	41	14	160	32.3	1145352081	24-SDAE45-L28-M33F
L 35	M 42 x 2	PN 160	50.5	30	30	62	37.5	27	48	41	50	14	210	53.7	1145402081	24-SDAE45-L35-M42F
L 42	M 48 x 2	PN 160	55.5	36	36	65	51	40	49	50	55	16	260	69.5	1145452081	24-SDAE45-L42-M48F
S 6	M 12 x 1.5	PN 400	17.5	4	4	32	23.8	16	22	19	17	10	35	7.6	1145502081	24-SDAE45-S6-M12F
S 8	M 14 x 1.5	PN 400	19.5	6	5	36	24	17	26	19	19	10	45	9.1	1145552081	24-SDAE45-S8-M14F
S 10	M 16 x 1.5	PN 400	22.5	7	7	38	25.5	18	27	19	22	11	55	10.4	1145602081	24-SDAE45-S10-M16F
S 12	M 18 x 1.5	PN 400	24.5	9	8	43	24.5	17	31	19	24	12	70	12.4	1145652081	24-SDAE45-S12-M18F
S 16	M 22 x 1.5	PN 400	27.5	12	12	49	27.5	19	35	24	27	14	100	18.3	1145752081	24-SDAE45-S16-M22F
S 20	M 27 x 2	PN 400	32.5	15	16	55	32	21.5	39	27	32	16	170	27.7	1145802081	24-SDAE45-S20-M27F
S 25	M 33 x 2	PN 315	44.5	20	20	60	35	23	44	36	41	16	310	45.2	1145852081	24-SDAE45-S25-M33F
S 30	M 42 x 2	PN 250	50.5	26	25	68	37.5	24	51	41	50	17	330	72.0	1145902081	24-SDAE45-S30-M42F
S 38	M 48 x 2	PN 200	55.5	32	32	73	44	28	54	50	55	19	420	104.2	1145952081	24-SDAE45-S38-M48F

Example for comp. :
VEE06LMOROMD

Adjustable L couplings with lock nut

Male thread: metric fine thread,
ISO 6149, parallel

Sealing with O-ring

Standard O-ring material is NBR

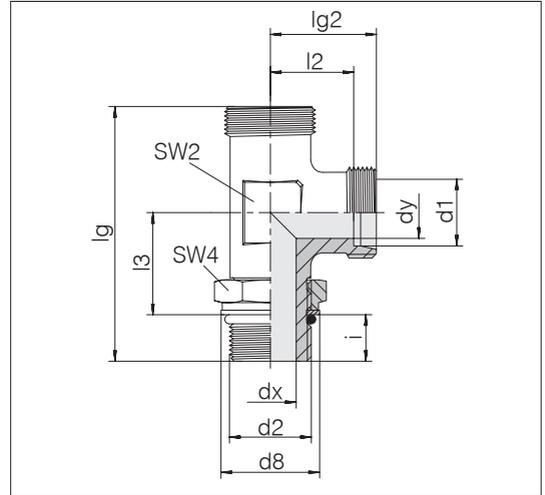

Series	d2	Pressure	d8	dx	dy	lg	lg2	l2	l3	SW2	SW4	i	Nm -10 %	kg/100 ca.	Order-No.	Designation	
L	6	M 10 x 1	PN 315	14.5	4.5	4	48	21	14	20	14	14	7	15	4.8	1146002081	24-SDAL-L6-M10F
L	8	M 12 x 1.5	PN 315	17.5	6	6	55	23	16	22	17	17	10	25	6.9	1146052081	24-SDAL-L8-M12F
L	10	M 14 x 1.5	PN 315	19.5	7.5	8	59	24	17	25	17	19	10	35	7.0	1146102081	24-SDAL-L10-M14F
L	12	M 16 x 1.5	PN 315	22.5	9	10	62	26	19	26	19	22	10	40	10.6	1146152081	24-SDAL-L12-M16F
L	15	M 18 x 1.5	PN 315	24.5	11	12	69	28	21	30	19	24	11	45	12.2	1146202081	24-SDAL-L15-M18F
L	18	M 22 x 1.5	PN 315	27.5	14	15	79	34	26.5	33	27	27	12	60	25.4	1146252081	24-SDAL-L18-M22F
L	22	M 27 x 2	PN 160	32.5	18	19	84	35	27.5	35	27	32	14	100	28.2	1146302081	24-SDAL-L22-M27F
L	28	M 33 x 2	PN 160	41.5	23	24	90	38	30.5	38	36	41	14	160	46.8	1146352081	24-SDAL-L28-M33F
L	35	M 42 x 2	PN 160	50.5	30	30	107	45	34.5	48	41	50	14	210	90.1	1146402081	24-SDAL-L35-M42F
L	42	M 48 x 2	PN 160	55.5	36	36	116	51	40	49	50	55	16	260	102.8	1146452081	24-SDAL-L42-M48F
S	6	M 12 x 1.5	PN 400	17.5	4	4	55	23	16	22	17	17	10	35	7.5	1146502081	24-SDAL-S6-M12F
S	8	M 14 x 1.5	PN 400	19.5	6	5	60	24	17	26	17	19	10	45	8.9	1146552081	24-SDAL-S8-M14F
S	10	M 16 x 1.5	PN 400	22.5	7	7	65	27	19.5	27	19	22	11	55	13.4	1146602081	24-SDAL-S10-M16F
S	12	M 18 x 1.5	PN 400	24.5	9	8	75	32	24.5	31	27	24	12	70	26.7	1146652081	24-SDAL-S12-M18F
S	16	M 22 x 1.5	PN 400	27.5	12	12	82	33	24.5	35	22	27	14	100	30.2	1146752081	24-SDAL-S16-M22F
S	20	M 27 x 2	PN 400	32.5	15	16	92	37	26.5	39	27	32	16	170	37.7	1146802081	24-SDAL-S20-M27F
S	25	M 33 x 2	PN 315	41.5	20	20	102	42	30	44	36	41	16	310	66.7	1146852081	24-SDAL-S25-M33F
S	30	M 42 x 2	PN 250	50.5	26	25	117	49	35.5	51	41	50	17	330	116.4	1146902081	24-SDAL-S30-M42F
S	38	M 48 x 2	PN 200	55.5	32	32	130	57	41	54	50	55	19	420	151.4	1146952081	24-SDAL-S38-M48F

Example for comp. :
LEE06LMOROMD

Adjustable T couplings with lock nut

Male thread: metric fine thread,
ISO 6149, parallel

Sealing with O-ring

Standard O-ring material is NBR

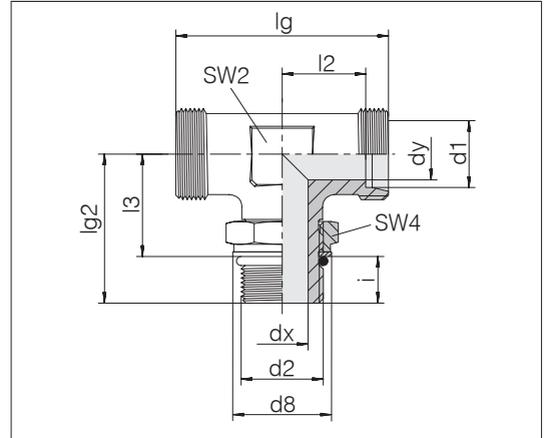

Series	d2	Pressure	d8	dx	dy	lg	lg2	l2	l3	SW2	SW4	i	Nm -10 %	kg/100 ca.	Order-No.	Designation	
Tube OD d1																	
L	6	M 10 x 1	PN 315	14.5	4.5	4	44	27	15	20	14	14	7	15	4.7	1147002081	24-SDAT-L6-M10F
L	8	M 12 x 1.5	PN 315	17.5	6	6	44	32	15	22	14	17	10	25	5.5	1147052081	24-SDAT-L8-M12F
L	10	M 14 x 1.5	PN 315	19.5	7.5	8	49	35	17.5	25	17	19	10	35	7.3	1147102081	24-SDAT-L10-M14F
L	12	M 16 x 1.5	PN 315	22.5	9	10	54	36	20	26	19	22	10	40	10.8	1147152081	24-SDAT-L12-M16F
L	15	M 18 x 1.5	PN 315	24.5	11	12	56	41	21	30	22	24	11	45	15.4	1147202081	24-SDAT-L15-M18F
L	18	M 22 x 1.5	PN 315	27.5	14	15	66	45	25.5	33	27	27	12	60	81.3	1147252081	24-SDAT-L18-M22F
L	22	M 27 x 2	PN 160	32.5	18	19	70	49	27.5	35	27	32	14	100	28.2	1147302081	24-SDAT-L22-M27F
L	28	M 33 x 2	PN 160	41.5	23	24	76	52	30.5	38	36	41	14	160	47.3	1147352081	24-SDAT-L28-M33F
L	35	M 42 x 2	PN 160	50.5	30	30	90	62	34.5	48	41	50	14	210	90.1	1147402081	24-SDAT-L35-M42F
L	42	M 48 x 2	PN 160	55.5	36	36	102	65	40	49	50	55	16	260	102.8	1147452081	24-SDAT-L42-M48F
S	6	M 12 x 1.5	PN 400	17.5	4	4	44	32	15	22	17	17	10	35	7.3	1147502081	24-SDAT-S6-M12F
S	8	M 14 x 1.5	PN 400	19.5	6	5	54	36	20	26	19	19	10	45	12.4	1147552081	24-SDAT-S8-M14F
S	10	M 16 x 1.5	PN 400	22.5	7	7	55	38	20	27	19	22	11	55	13.5	1147602081	24-SDAT-S10-M16F
S	12	M 18 x 1.5	PN 400	24.5	9	8	58	43	21.5	31	22	24	12	70	18.7	1147652081	24-SDAT-S12-M18F
S	16	M 22 x 1.5	PN 400	27.5	12	12	66	49	24.5	35	22	27	14	100	21.8	1147752081	24-SDAT-S16-M22F
S	20	M 27 x 2	PN 400	32.5	15	16	74	55	26.5	39	27	32	16	170	37.7	1147802081	24-SDAT-S20-M27F
S	25	M 33 x 2	PN 315	41.5	20	20	84	60	30	44	36	41	16	310	66.8	1147852081	24-SDAT-S25-M33F
S	30	M 42 x 2	PN 250	50.5	26	25	98	68	35.5	51	41	50	17	330	116.8	1147902081	24-SDAT-S30-M42F
S	38	M 48 x 2	PN 200	55.5	32	32	114	73	41	54	50	55	19	420	151.5	1147952081	24-SDAT-S38-M48F

Example for comp. :
TEE06LMOROMD

Welding couplings

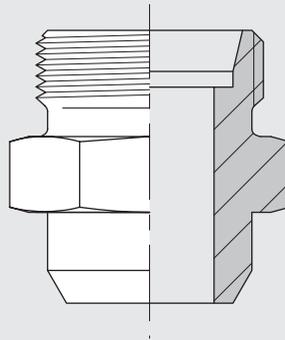

Straight welding couplings

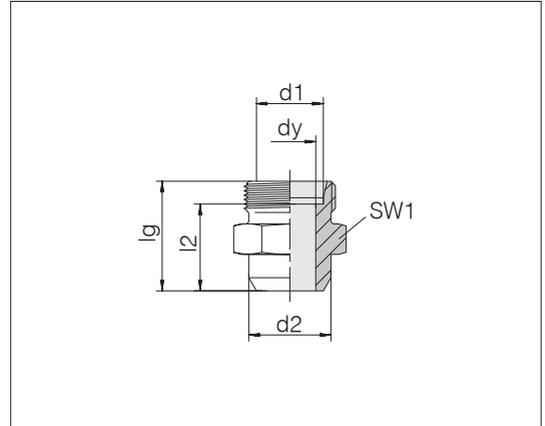

Series	Pressure	d2	dy	lg	l2	SW1	kg/100 ca.	Order-No.	Designation
Tube OD d1									
L 6	PN 315	10	4	21	14	12	1.0	0739000000	24-WDS-L6-C00
L 8	PN 315	12	6	23	16	14	1.5	0739050000	24-WDS-L8-C00
L 10	PN 315	14	8	25	18	17	2.1	0739100000	24-WDS-L10-C00
L 12	PN 315	16	10	25	18	19	2.6	0739150000	24-WDS-L12-C00
L 15	PN 315	19	12	29	22	22	4.3	0739200000	24-WDS-L15-C00
L 18	PN 315	22	15	31	23.5	27	6.6	0739250000	24-WDS-L18-C00
L 22	PN 160	27	19	36	28.5	32	9.7	0739300000	24-WDS-L22-C00
L 28	PN 160	32	24	38	30.5	41	15.9	0739350000	24-WDS-L28-C00
L 35	PN 160	40	30	43	32.5	46	22.8	0739400000	24-WDS-L35-C00
L 42	PN 160	46	36	46	35	55	32.8	0739450000	24-WDS-L42-C00
S 6	PN 630	11	4	26	19	14	2.1	0739500000	24-WDS-S6-C00
S 8	PN 630	13	5	28	21	17	3.0	0739550000	24-WDS-S8-C00
S 10	PN 630	15	7	30	22.5	19	4.0	0739600000	24-WDS-S10-C00
S 12	PN 630	17	8	32	24.5	22	5.5	0739650000	24-WDS-S12-C00
S 14	PN 630	19	10	35	27	24	7.0	0739700000	24-WDS-S14-C00
S 16	PN 400	21	12	35	26.5	27	8.3	0739750000	24-WDS-S16-C00
S 20	PN 400	26	16	40	29.5	32	12.9	0739800000	24-WDS-S20-C00
S 25	PN 400	31	20	44	32	41	22.2	0739850000	24-WDS-S25-C00
S 30	PN 400	36	25	49	35.5	46	29.5	0739900000	24-WDS-S30-C00
S 38	PN 315	44	32	54	38	55	45.5	0739950000	24-WDS-S38-C00

Example for comp. :
AS06LX
ISO 8434-1-WDS-L6-St

Welding bulkhead couplings

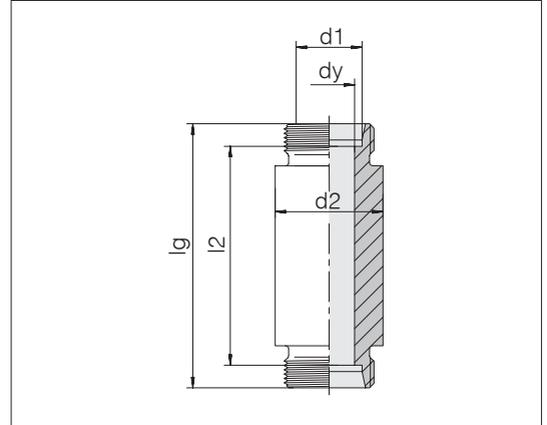

Series	Tube OD	Pressure	d2	dy	lg	l2	kg/100 ca.	Order-No.	Designation
L	6	PN 315	18	4	70	56	10.3	0741000000	24-WDBHS-L6-C00
L	8	PN 315	20	6	70	56	12.1	0741050000	24-WDBHS-L8-C00
L	10	PN 315	22	8	72	58	14.3	0741100000	24-WDBHS-L10-C00
L	12	PN 315	25	10	72	58	17.7	0741150000	24-WDBHS-L12-C00
L	15	PN 315	28	12	84	70	25.9	0741200000	24-WDBHS-L15-C00
L	18	PN 315	32	15	84	69	33.4	0741250000	24-WDBHS-L18-C00
L	22	PN 160	36	19	88	73	40.0	0741300000	24-WDBHS-L22-C00
L	28	PN 160	40	24	88	73	44.5	0741350000	24-WDBHS-L28-C00
L	35	PN 160	50	30	92	71	72.3	0741400000	24-WDBHS-L35-C00
L	42	PN 160	60	36	92	70	100.5	0741450000	24-WDBHS-L42-C00
S	6	PN 630	20	4	74	60	13.5	0741500000	24-WDBHS-S6-C00
S	8	PN 630	22	5	74	60	16.2	0741550000	24-WDBHS-S8-C00
S	10	PN 630	25	7	74	59	20.0	0741600000	24-WDBHS-S10-C00
S	12	PN 630	28	8	74	59	25.0	0741650000	24-WDBHS-S12-C00
S	14	PN 630	30	10	88	72	33.7	0741700000	24-WDBHS-S14-C00
S	16	PN 400	35	12	88	71	44.4	0741750000	24-WDBHS-S16-C00
S	20	PN 400	38	16	92	71	51.5	0741800000	24-WDBHS-S20-C00
S	25	PN 400	45	20	96	72	72.3	0741850000	24-WDBHS-S25-C00
S	30	PN 400	50	25	100	73	87.3	0741900000	24-WDBHS-S30-C00
S	38	PN 315	60	32	104	72	125.1	0741950000	24-WDBHS-S38-C00

Example for comp. :
 ESV06LX
 ISO 8434-1-WDBHS-L6-St

Welding nipples with O-ring seal

Standard O-ring material is NBR

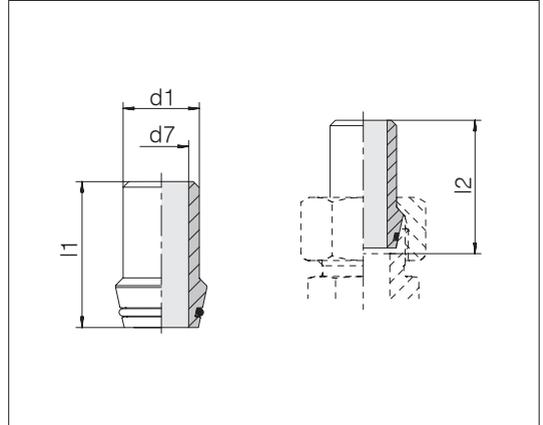

Series	for tube	Pressure	d7	l1	l2	kg/100 ca.	O-ring dimensions	Order-No.	Designation
L/S 6	6 x 1.5	PN 500	3	31	31.5	0.7	4 x 1.5	0070519967	24-WDNPSO-6x1,5-C10
L/S 8	8 x 1.5	PN 400	5	31	31.5	1.1	6 x 1.5	0070569967	24-WDNPSO-8x1,5-C10
L/S 8	8 x 2	PN 500	4	31	31.5	1.1	6 x 1.5	0070579967	24-WDNPSO-8x2-C10
L/S 10	10 x 1	PN 250	8	32.5	33.5	1.3	7.5 x 1.5	0070609967	24-WDNPSO-10x1-C10
L/S 10	10 x 1.5	PN 315	7	32.5	33.5	1.5	7.5 x 1.5	0070619967	24-WDNPSO-10x1,5-C10
L/S 10	10 x 2	PN 400	6	32.5	33.5	1.6	7.5 x 1.5	0070629967	24-WDNPSO-10x2-C10
L/S 10	10 x 2.5	PN 500	5	32.5	33.5	1.8	7.5 x 1.5	0070639967	24-WDNPSO-10x2,5-C10
L/S 12	12 x 1.5	PN 315	9	32.5	33.5	1.9	9 x 1.5	0070669967	24-WDNPSO-12x1,5-C10
L/S 12	12 x 2	PN 400	8	32.5	33.5	1.9	9 x 1.5	0070679967	24-WDNPSO-12x2-C10
L/S 12	12 x 2.5	PN 400	7	32.5	33.5	2.2	9 x 1.5	0070689967	24-WDNPSO-12x2,5-C10
L 15	15 x 2	PN 315	11	34.5	34.5	2.4	12 x 2	0069009967	24-WDNPSO-15x2-C10
L 15	15 x 2.5	PN 315	10	34.5	34.5	2.9	12 x 2	0069019967	24-WDNPSO-15x2,5-C10
L 18	18 x 2.5	PN 315	13	36	37	3.9	15 x 2	0069029967	24-WDNPSO-18x2,5-C10
L 22	22 x 2.5	PN 160	17	38.5	39.5	5.2	20 x 2	0069079967	24-WDNPSO-22x2,5-C10
L 28	28 x 2.5	PN 160	23	41.5	42.5	7.3	26 x 2	0069039967	24-WDNPSO-28x2,5-C10
L 28	28 x 3	PN 160	22	41.5	42.5	8.4	26 x 2	0070039967	24-WDNPSO-28x3-C10
L 35	35 x 3.5	PN 160	28	47.5	49.5	14.4	32 x 2.5	0069049967	24-WDNPSO-35x3,5-C10
L 35	35 x 4	PN 160	27	47.5	49.5	16.0	32 x 2.5	0069059967	24-WDNPSO-35x4-C10
L 42	42 x 3	PN 160	36	47.5	50	15.4	38 x 2.5	0070009967	24-WDNPSO-42x3-C10
L 42	42 x 4	PN 160	34	47.5	50	19.5	38 x 2.5	0070049967	24-WDNPSO-42x4-C10



Welding nipples with O-ring seal

Standard O-ring material is NBR

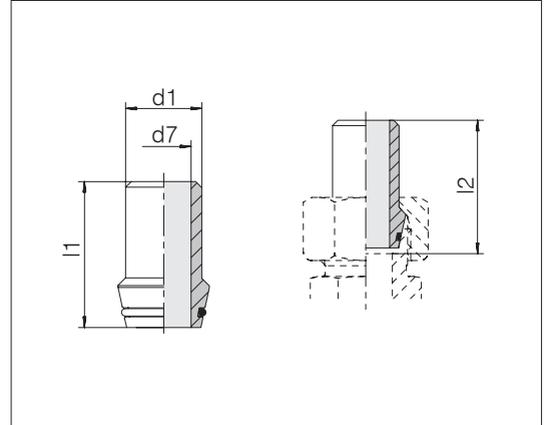

Series	Tube OD	d1	for tube	Pressure	d7	l1	l2	kg/100 ca.	O-ring dimensions	Order-No.	Designation
S	14	14 x 2	PN 315	10	38.5	39.5	3.0	10 x 2	0070729967	24-WDNPSO-14x2-C10	
S	14	14 x 2.5	PN 400	9	38.5	39.5	3.1	10 x 2	0070739967	24-WDNPSO-14x2,5-C10	
S	14	14 x 3	PN 400	8	38.5	39.5	3.5	10 x 2	0070749967	24-WDNPSO-14x3-C10	
S	16	16 x 1.5	PN 250	13	39	41	3.1	12 x 2	0070769967	24-WDNPSO-16x1,5-C10	
S	16	16 x 2	PN 315	12	39	41	3.6	12 x 2	0070779967	24-WDNPSO-16x2-C10	
S	16	16 x 2.5	PN 400	11	39	41	3.6	12 x 2	0070789967	24-WDNPSO-16x2,5-C10	
S	16	16 x 3	PN 400	10	39	41	4.4	12 x 2	0070799967	24-WDNPSO-16x3-C10	
S	20	20 x 2	PN 250	16	45	47	6.0	16.3 x 2.4	0070819967	24-WDNPSO-20x2-C10	
S	20	20 x 2.5	PN 315	15	45	47	6.4	16.3 x 2.4	0070829967	24-WDNPSO-20x2,5-C10	
S	20	20 x 3	PN 400	14	45	47	6.4	16.3 x 2.4	0070839967	24-WDNPSO-20x3-C10	
S	20	20 x 4	PN 400	12	45	47	7.8	16.3 x 2.4	0070849967	24-WDNPSO-20x4-C10	
S	25	25 x 2.5	PN 250	20	50	53.5	10.1	20.3 x 2.4	0070869967	24-WDNPSO-25x2,5-C10	
S	25	25 x 3	PN 315	19	50	53.5	10.2	20.3 x 2.4	0070879967	24-WDNPSO-25x3-C10	
S	25	25 x 3.5	PN 315	18	50	53.5	10.0	20.3 x 2.4	0070909967	24-WDNPSO-25x3,5-C10	
S	25	25 x 4	PN 400	17	50	53.5	11.2	20.3 x 2.4	0070889967	24-WDNPSO-25x4-C10	
S	25	25 x 5	PN 400	15	50	53.5	13.1	20.3 x 2.4	0070899967	24-WDNPSO-25x5-C10	
S	30	30 x 3	PN 250	24	52	57	10.8	25.3 x 2.4	0070929967	24-WDNPSO-30x3-C10	
S	30	30 x 4	PN 315	22	52	57	14.5	25.3 x 2.4	0070939967	24-WDNPSO-30x4-C10	
S	30	30 x 5	PN 400	20	52	57	17.1	25.3 x 2.4	0070949967	24-WDNPSO-30x5-C10	
S	30	30 x 6	PN 400	18	52	57	19.5	25.3 x 2.4	0070959967	24-WDNPSO-30x6-C10	
S	38	38 x 3	PN 160	32	56.5	64	16.4	33.3 x 2.4	0070509967	24-WDNPSO-38x3-C10	
S	38	38 x 4	PN 315	30	56.5	64	20.6	33.3 x 2.4	0070979967	24-WDNPSO-38x4-C10	
S	38	38 x 5	PN 315	28	56.5	64	24.5	33.3 x 2.4	0070989967	24-WDNPSO-38x5-C10	
S	38	38 x 6	PN 315	26	56.5	64	28.1	33.3 x 2.4	0070999967	24-WDNPSO-38x6-C10	
S	38	38 x 7	PN 315	24	56.5	64	31.6	33.3 x 2.4	0070969967	24-WDNPSO-38x7-C10	

Female stud and gauge couplings

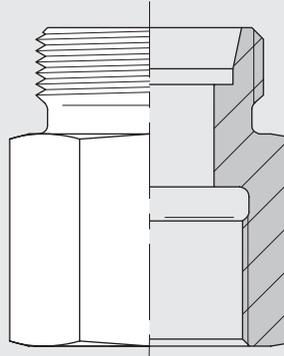

Straight female stud couplings

Internal thread: metric fine thread

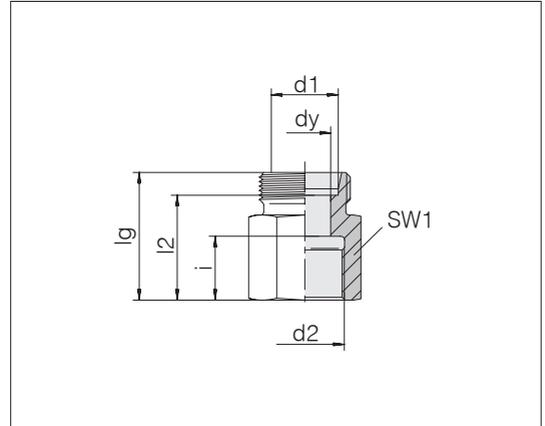

Series	d2	Pressure	dy	lg	l2	SW1	i	kg/100 ca.	Order-No.	Designation
Tube OD d1										
L 6	M 10 x 1	PN 315	4	26.5	19.5	14	12.5	1.8	0743002000	24-S-L6-IM10
L 8	M 10 x 1	PN 315	6	26.5	19.5	14	12.5	1.8	0743062000	24-S-L8-IM10
L 8	M 12 x 1.5	PN 315	6	31	24	17	17	3.1	0743052000	24-S-L8-IM12
L 10	M 14 x 1.5	PN 315	8	32	25	19	17	3.7	0743102000	24-S-L10-IM14
L 12	M 16 x 1.5	PN 315	10	33	26	22	17	5.1	0743152000	24-S-L12-IM16
L 15	M 18 x 1.5	PN 315	12	35	28	24	17	6.5	0743202000	24-S-L15-IM18
L 18	M 22 x 1.5	PN 315	15	37	29.5	30	19	10.9	0743252000	24-S-L18-IM22
L 22	M 26 x 1.5	PN 160	19	42	34.5	32	21	12.1	0743302000	24-S-L22-IM26
L 28	M 33 x 2	PN 160	24	45	37.5	41	24	20.8	0743352000	24-S-L28-IM33
L 35	M 42 x 2	PN 160	30	51	40.5	55	26	45.2	0743402000	24-S-L35-IM42
L 42	M 48 x 2	PN 160	36	53	42	60	28	51.5	0743452000	24-S-L42-IM48
S 6	M 10 x 1	PB 630	4	32.5	25.5	19	16.5	4.8	0743512000	24-S-S6-IM10
S 6	M 12 x 1.5	PB 630	4	33	26	17	17	3.0	0743502000	24-S-S6-IM12
S 8	M 14 x 1.5	PB 630	5	33	26	19	17	4.2	0743552000	24-S-S8-IM14
S 10	M 16 x 1.5	PB 630	7	34	26.5	22	17	5.8	0743602000	24-S-S10-IM16
S 12	M 18 x 1.5	PB 630	8	35	27.5	24	17	6.9	0743652000	24-S-S12-IM18
S 14	M 20 x 1.5	PB 630	10	39	31	27	19	9.6	0743702000	24-S-S14-IM20
S 16	M 22 x 1.5	PB 400	12	39	30.5	30	19	11.5	0743752000	24-S-S16-IM22
S 20	M 27 x 2	PB 400	16	45	34.5	36	22	18.6	0743802000	24-S-S20-IM27
S 25	M 33 x 2	PB 400	20	49	37	41	24	24.1	0743852000	24-S-S25-IM33
S 30	M 42 x 2	PB 400	25	55	41.5	55	26	49.3	0743902000	24-S-S30-IM42
S 38	M 48 x 2	PB 315	32	59	43	60	28	60.5	0743952000	24-S-S38-IM48

Example for comp. :
GAI06LMX



Straight female stud couplings

Internal thread: Whitworth pipe thread

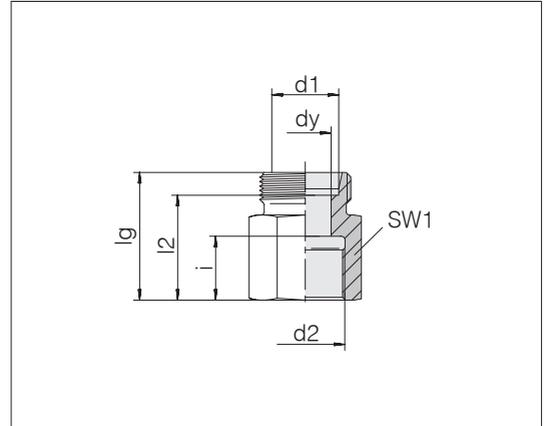

Series	Tube OD	d2	Pressure	dy	lg	l2	SW1	i	kg/100 ca.	Order-No.	Designation
L	6	G 1/8	PN 315	4	26	19	14	12	1.8	0744002000	24-S-L6-IG1/8
L	6	G 1/4	PN 315	4	31	24	19	7	3.7	0744022000	24-S-L6-IG1/4
L	6	G 3/8	PN 315	4	33	26	24	7	6.4	0744032000	24-S-L6-IG3/8
L	8	G 1/4	PN 315	6	31	24	19	17	3.8	0744052000	24-S-L8-IG1/4
L	8	G 3/8	PN 315	6	32	25	24	17	6.2	0744072000	24-S-L8-IG3/8
L	8	G 1/2	PN 315	6	36	29	27	7	7.9	0744082000	24-S-L8-IG1/2
L	10	G 1/4	PN 315	8	32	25	19	17	3.9	0744102000	24-S-L10-IG1/4
L	10	G 3/8	PN 315	8	33	26	24	17	6.2	0744122000	24-S-L10-IG3/8
L	10	G 1/2	PN 315	8	37	30	27	20	8.1	0744132000	24-S-L10-IG1/2
L	12	G 1/4	PN 315	9	32	25	19	17	4.0	0744162000	24-S-L12-IG1/4
L	12	G 3/8	PN 315	10	33	26	24	17	6.2	0744152000	24-S-L12-IG3/8
L	12	G 1/2	PN 315	10	38	31	27	20	8.4	0744172000	24-S-L12-IG1/2
L	15	G 3/8	PN 315	12	34	27	24	7	6.8	0744212000	24-S-L15-IG3/8
L	15	G 1/2	PN 315	12	38	31	27	20	8.6	0744202000	24-S-L15-IG1/2
L	18	G 1/2	PN 315	15	38	30.5	27	20	8.9	0744252000	24-S-L18-IG1/2
L	22	G 3/4	PN 160	19	43	35.5	36	22	17.3	0744302000	24-S-L22-IG3/4
L	28	G 1	PN 160	24	45.5	38	41	24.5	20.9	0744352000	24-S-L28-IG1
L	35	G 1	PN 160	30.5	47.5	37	46	10.5	32.4	0744412000	24-S-L35-IG1
L	35	G 1 1/4	PN 160	30	51.5	41	55	26.5	45.7	0744402000	24-S-L35-IG11/4
L	42	G 1 1/2	PN 160	36	53.5	42.5	60	28.5	52.8	0744452000	24-S-L42-IG11/2

Straight female stud couplings

Internal thread: Whitworth pipe thread

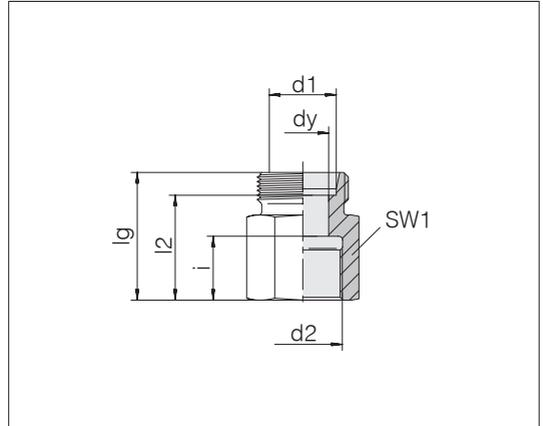

Series	d2	Pressure	dy	lg	l2	SW1	i	kg/100 ca.	Order-No.	Designation
Tube OD d1										
S 6	G 1/4	PB 630	4	33	26	19	17	4.2	0744502000	24-S-S6-IG1/4
S 8	G 1/4	PB 630	5	33	26	19	17	4.4	0744552000	24-S-S8-IG1/4
S 10	G 3/8	PB 630	7	34	26.5	24	17	6.9	0744602000	24-S-S10-IG3/8
S 12	G 1/4	PB 630	8	34	26.5	22	17	6.8	0744662000	24-S-S12-IG1/4
S 12	G 3/8	PB 630	8	34	26.5	24	17	7.1	0744652000	24-S-S12-IG3/8
S 12	G 1/2	PB 630	8	38	30.5	27	20	8.8	0744672000	24-S-S12-IG1/2
S 14	G 1/2	PB 630	10	40	32	27	20	9.4	0744702000	24-S-S14-IG1/2
S 16	G 1/2	PB 400	12	40	31.5	27	20	9.3	0744752000	24-S-S16-IG1/2
S 20	G 3/4	PB 400	16	45	34.5	36	22	18.9	0744802000	24-S-S20-IG3/4
S 25	G 1	PB 400	20	49.5	37.5	41	24.5	24.0	0744852000	24-S-S25-IG1
S 30	G 1 1/4	PB 400	25	55.5	42	55	26.5	50.3	0744902000	24-S-S30-IG1 1/4
S 38	G 1 1/2	PB 315	32	59.5	43.5	60	28.5	61.5	0744952000	24-S-S38-IG1 1/2

Gauge couplings

Internal thread: Whitworth pipe thread

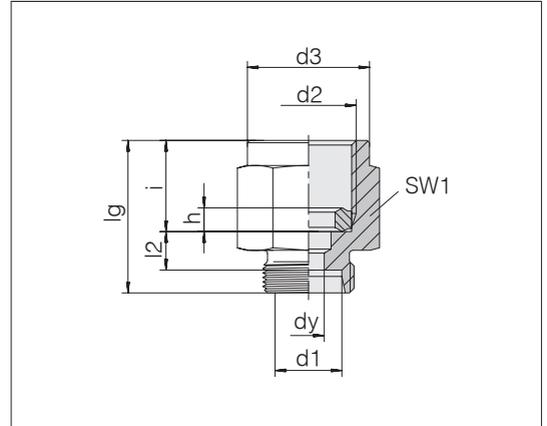

Series	Tube OD	d2	Pressure	d3	dy	lg	l2	SW1	h	i	kg/100 ca.	Order-No.	Designation
L	6	G 1/4	PN 315	18.8	4	29	7.5	19	4.6	14.5	3.4	0142002081	24-PGS-L6-IG1/4B
L	8	G 1/4	PN 315	18.8	4	29	7.5	19	4.6	14.5	3.6	0142052081	24-PGS-L8-IG1/4B
L	10	G 1/4	PN 315	18.8	4	30	8.5	19	4.6	14.5	3.9	0142102081	24-PGS-L10-IG1/4B
L	12	G 1/4	PN 315	18.8	4	30	8.5	19	4.6	14.5	4.0	0142152081	24-PGS-L12-IG1/4B
S	6	G 1/2	PN 630	26.8	4	38	11	27	5.2	20	8.2	0142502081	24-PGS-S6-IG1/2B
S	8	G 1/4	PN 630	18.8	4	31	9.5	19	4.6	14.5	4.2	0142562081	24-PGS-S8-IG1/4B
S	8	G 1/2	PN 630	26.8	5	38	11	27	5.2	20	8.5	0142552081	24-PGS-S8-IG1/2B
S	10	G 1/2	PN 630	26.8	5	38	10.5	27	5.2	20	8.8	0142602081	24-PGS-S10-IG1/2B
S	12	G 1/4	PN 630	21.8	4	31	9	22	4.6	14.5	6.2	0142662081	24-PGS-S12-IG1/4B
S	12	G 1/2	PN 630	26.8	5	38	10.5	27	5.2	20	9.0	0142652081	24-PGS-S12-IG1/2B

Example for comp. :
MAV06LROMD

Gauge couplings

Internal thread: Whitworth pipe thread

Tube socket pre-assembled

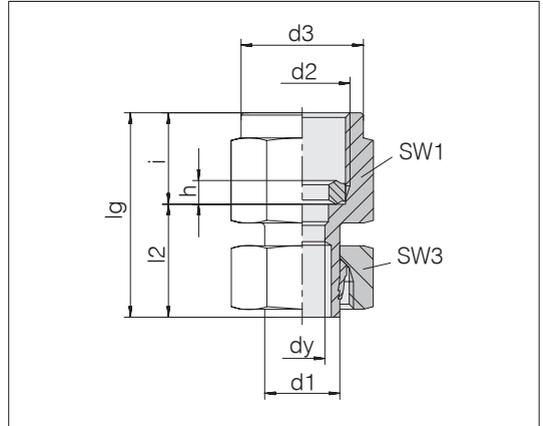

Series	d2	Pressure	d3	dy	lg	l2	SW1	h	SW3	i	kg/100 ca.	Order-No.	Designation
Tube OD													
d1													
L 6	G 1/8	PN 315	18.8	2.5	39	23.5	19		14	14.5	5.2	0142032007	24-SWPGS-L6-IG1/8B
L 6	G 1/4	PN 315	18.8	2.5	38	23.5	19	4.6	14	14.5	4.8	0142042007	24-SWPGS-L6-IG1/4B
L 8	G 1/4	PN 315	18.8	2.5	38	23.5	19	4.6	17	14.5	5.5	0142092007	24-SWPGS-L8-IG1/4B
L 10	G 1/4	PN 315	18.8	2.5	39.5	25	19	4.6	19	14.5	6.2	0142132007	24-SWPGS-L10-IG1/4B
L 12	G 1/4	PN 315	18.8	2.5	40.5	26	19	4.6	22	14.5	7.4	0142182007	24-SWPGS-L12-IG1/4B
S 6	G 1/2	PN 630	26.8	2.5	45	25	27	5.2	17	20	9.9	0142542007	24-SWPGS-S6-IG1/2B
S 8	G 1/2	PN 630	26.8	3.5	45	25	27	5.2	19	20	10.4	0142592007	24-SWPGS-S8-IG1/2B
S 10	G 1/2	PN 630	26.8	3.5	47	27	27	5.2	22	20	12.0	0142612007	24-SWPGS-S10-IG1/2B
S 12	G 1/2	PN 630	26.8	3.5	47.5	27.5	27	5.2	24	20	12.9	0142692007	24-SWPGS-S12-IG1/2B

Example for comp. :
MAVEV06LR

L 6 (G 1/8) without sealing-edge ring.

Gauge couplings

Internal thread: Whitworth pipe thread

Plug-in version with taper and O-ring
fit in bore type W DIN 3861 / ISO 8434-1

Standard O-ring material is FPM/FKM

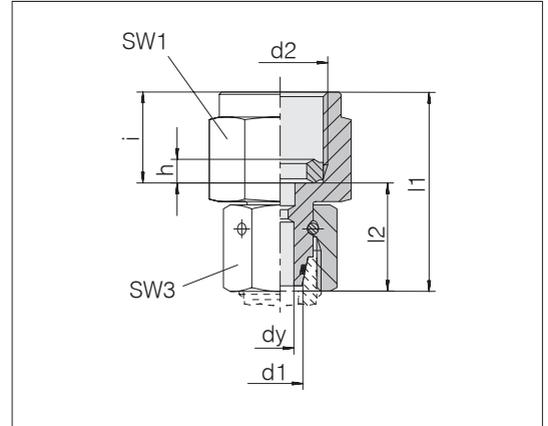

Series	d2	Pressure	dy	l1	l2	SW1	SW3	h	i	kg/100 ca.	Order-No.	Designation	
L Tube OD d1													
L	6	G 1/4	PN 315	2.5	37.5	23	19	14	4.6	14.5	4.8	1142002058	24-SWOPGS-L6-IG1/4B
L	8	G 1/4	PN 315	4.5	37.5	23	19	17	4.6	14.5	5.5	1142052058	24-SWOPGS-L8-IG1/4B
L	10	G 1/4	PN 315	6	36	21.5	19	19	4.6	14.5	5.8	1142102058	24-SWOPGS-L10-IG1/4B
L	12	G 1/4	PN 315	8	36	21.5	19	22	4.6	14.5	6.9	1142152058	24-SWOPGS-L12-IG1/4B
L	12	G 1/2	PN 630	3.5	42	22	27	22	5.2	20	11.4	1142672058	24-SWOPGS-L12-IG1/2B
L	15	G 1/2	PN 315	3.5	44.5	24.5	27	27	5.2	20	14.2	1142202058	24-SWOPGS-L15-IG1/2B
S	6	G 1/4	PN 630	2.5	35.5	21	19	17	4.6	14.5	5.4	1142522058	24-SWOPGS-S6-IG1/4B
S	6	G 1/2	PN 630	2.5	44.5	24.5	27	17	5.2	20	10.3	1142502058	24-SWOPGS-S6-IG1/2B
S	8	G 1/4	PN 630	4	35.5	21	19	19	4.6	14.5	5.7	1142572058	24-SWOPGS-S8-IG1/4B
S	8	G 1/2	PN 630	4	44.5	24.5	27	19	5.2	20	11.7	1142552058	24-SWOPGS-S8-IG1/2B
S	10	G 1/4	PN 630	2.5	39	24.5	19	22	4.6	14.5	7.8	1142622058	24-SWOPGS-S10-IG1/4B
S	10	G 1/2	PN 630	6	43.5	23.5	27	22	5.2	20	11.3	1142602058	24-SWOPGS-S10-IG1/2B
S	12	G 1/4	PN 630	8	39	24.5	19	24	4.6	14.5	8.2	1142662058	24-SWOPGS-S12-IG1/4B
S	12	G 1/2	PN 630	8	45	25	27	24	5.2	20	12.2	1142652058	24-SWOPGS-S12-IG1/2B

Example for comp. :
MAVE06LRVIT

Thread reducing couplings

Both threads: Whitworth pipe thread, parallel

Sealing with seal edge

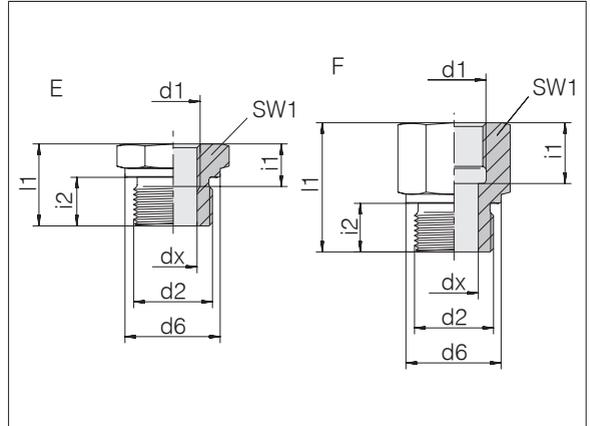

Male thread d2	Female thread d1	Pressure	d6	dx	l1	SW1	i1	i2	Form	Nm -10 %	kg/100 ca.	Order-No.	Designation
G 1/8 A	G 1/4	PB 630	14	4	31	19	17	8	F	25	3.7	0149012000	GP-SDS-G1/8B-IG1/4
G 1/8 A	G 3/8	PB 630	14	4	32	24	17	8	F	25	6.3	0149002000	GP-SDS-G1/8B-IG3/8
G 1/4 A	G 1/8	PB 630	18	7	30	19	13	12	F	60	4.0	0149052000	GP-SDS-G1/4B-IG1/8
G 1/4 A	G 3/8	PB 630	18	6	36	24	17	12	F	60	6.6	0149042000	GP-SDS-G1/4B-IG3/8
G 1/4 A	G 1/2	PB 630	18	5	40	27	20	12	F	60	8.6	0149032000	GP-SDS-G1/4B-IG1/2
G 1/4 A	G 3/4	PB 630	18	5	43	36	22	12	F	60	17.0	0149022000	GP-SDS-G1/4B-IG3/4
G 3/8 A	G 1/8	PB 400	22	8.5	22.5	22	8	12	E	110	3.9	0149092000	GP-SDS-G3/8B-IG1/8
G 3/8 A	G 1/4	PB 400	22	8	36	22	17	12	F	110	7.0	0149082000	GP-SDS-G3/8B-IG1/4
G 3/8 A	G 1/2	PB 400	22	8	41	27	20	12	F	110	9.6	0149072000	GP-SDS-G3/8B-IG1/2
G 3/8 A	G 3/4	PB 400	22	8	44	36	22	12	F	110	17.7	0149062000	GP-SDS-G3/8B-IG3/4
G 1/2 A	G 1/8	PB 400	26	8.5	24	27	8	14	E	200	6.6	0149152000	GP-SDS-G1/2B-IG1/8
G 1/2 A	G 1/4	PB 400	26	11.5	24	27	12	14	E	200	5.5	0149142000	GP-SDS-G1/2B-IG1/4
G 1/2 A	G 3/8	PB 400	26	12	36	27	17	14	F	200	9.1	0149132000	GP-SDS-G1/2B-IG3/8
G 1/2 A	G 3/4	PB 400	26	12	46	36	22	14	F	200	18.2	0149122000	GP-SDS-G1/2B-IG3/4
G 1/2 A	G 1	PB 400	26	12	49	41	24.5	14	F	200	22.1	0149112000	GP-SDS-G1/2B-IG1
G 1/2 A	G 1 1/4	PB 250	26	10	53	55	26.5	14	F	200	48.0	0149102000	GP-SDS-G1/2B-IG11/4
G 3/4 A	G 1/4	PB 400	32	11.5	26	32	12	16	E	320	10.2	0149212000	GP-SDS-G3/4B-IG1/4
G 3/4 A	G 3/8	PB 400	32	15	26	32	12	16	E	320	8.7	0149202000	GP-SDS-G3/4B-IG3/8
G 3/4 A	G 1/2	PB 400	32	16	41	32	20	16	F	320	14.4	0149192000	GP-SDS-G3/4B-IG1/2
G 3/4 A	G 1	PB 400	32	16	51	41	24.5	16	F	320	23.7	0149182000	GP-SDS-G3/4B-IG1
G 3/4 A	G 1 1/4	PB 250	32	16	55	55	26.5	16	F	320	48.7	0149172000	GP-SDS-G3/4B-IG11/4
G 3/4 A	G 1 1/2	PB 250	32	16	57	60	28.5	16	F	320	56.5	0149162000	GP-SDS-G3/4B-IG11/2
G 1 A	G 1/4	PB 400	39	11.5	29	41	12	18	E	500	19.5	0149272000	GP-SDS-G1B-IG1/4
G 1 A	G 3/8	PB 400	39	15	29	41	12	18	E	500	17.9	0149262000	GP-SDS-G1B-IG3/8
G 1 A	G 1/2	PB 400	39	19	29	41	14	18	E	500	15.4	0149252000	GP-SDS-G1B-IG1/2
G 1 A	G 3/4	PB 400	39	20	47	41	22	18	F	500	27.3	0149242000	GP-SDS-G1B-IG3/4
G 1 A	G 1 1/4	PB 250	39	20	57	55	26.5	18	F	500	50.9	0149232000	GP-SDS-G1B-IG11/4
G 1 A	G 1 1/2	PB 250	39	20	59	60	28.5	18	F	500	58.6	0149222000	GP-SDS-G1B-IG11/2

Thread reducing adapters with metric threads available upon request.

Example for comp. :
R11/8X1/4X

Continued on following page



Thread reducing couplings

Both threads: Whitworth pipe thread, parallel

Sealing with seal edge

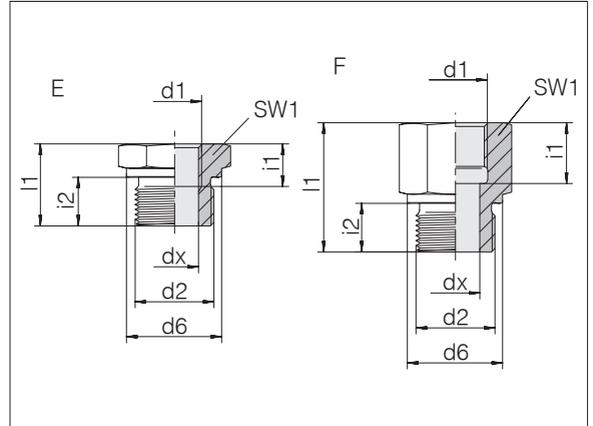

Male thread d2	Female thread d1	Pressure	d6	dx	l1	SW1	i1	i2	Form	Nm -10 %	kg/100 ca.	Order-No.	Designation
G 1 1/4 A	G 1/2	PB 250	49	19	32	50	14	20	E	600	31.0	0149312000	GP-SDS-G11/4B-IG1/2
G 1 1/4 A	G 3/4	PB 250	49	24	32	50	16	20	E	600	26.4	0149302000	GP-SDS-G11/4B-IG3/4
G 1 1/4 A	G 1	PB 250	49	25	52	50	24.5	20	F	600	45.8	0149292000	GP-SDS-G11/4B-IG1
G 1 1/4 A	G 1 1/2	PB 250	49	25	60	60	28.5	20	F	600	62.1	0149282000	GP-SDS-G11/4B-IG11/2
G 1 1/2 A	G 1/2	PB 250	55	19	36	55	14	22	E	800	47.8	0149352000	GP-SDS-G11/2B-IG1/2
G 1 1/2 A	G 3/4	PB 250	55	24	36	55	16	22	E	800	42.2	0149342000	GP-SDS-G11/2B-IG3/4
G 1 1/2 A	G 1	PB 250	55	30.5	36	55	18	22	E	800	34.0	0149332000	GP-SDS-G11/2B-IG1
G 1 1/2 A	G 1 1/4	PB 250	55	32	58	55	26.5	22	F	800	52.7	0149322000	GP-SDS-G11/2B-IG11/4

Thread reducing couplings

Both threads: Whitworth pipe thread, parallel

Sealing with PEFLEX profile seal ring

Standard profile seal ring material is NBR

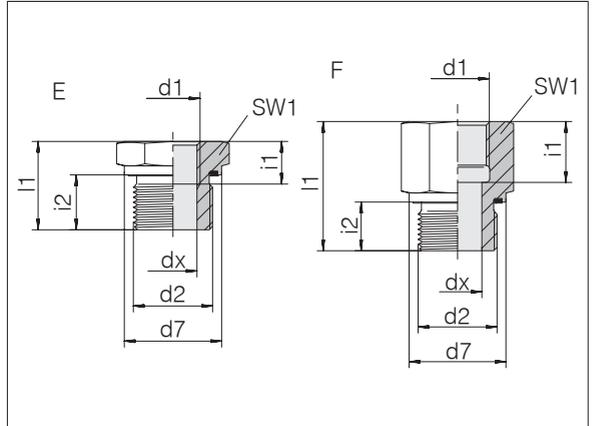

Male thread d2	Female thread d1	Pressure	d7	dx	l1	SW1	i1	i2	Form	Nm -10 %	kg/100 ca.	Order-No.	Designation
G 1/8 A	G 1/4	PN 630	13.9	4	32.5	19	17	8	F	20	4.2	1149012000	GP-SDS-G1/8E-IG1/4
G 1/8 A	G 3/8	PN 630	13.9	4	33.5	24	17	8	F	20	6.8	1149002000	GP-SDS-G1/8E-IG3/8
G 1/4 A	G 1/8	PN 630	18.9	5	31.5	19	12	12	F	60	4.6	1149052000	GP-SDS-G1/4E-IG1/8
G 1/4 A	G 3/8	PN 630	18.9	5	37.5	24	17	12	F	60	7.3	1149042000	GP-SDS-G1/4E-IG3/8
G 1/4 A	G 1/2	PN 630	18.9	5	41.5	30	20	12	F	60	12.4	1149032000	GP-SDS-G1/4E-IG1/2
G 1/4 A	G 3/4	PN 630	18.9	5	44.5	36	22	12	F	60	18.5	1149022000	GP-SDS-G1/4E-IG3/4
G 3/8 A	G 1/8	PN 630	21.9	8.5	22.5	22	8	12	E	90	3.8	1149092000	GP-SDS-G3/8E-IG1/8
G 3/8 A	G 1/4	PN 630	21.9	8	37.5	22	17	12	F	90	7.2	1149082000	GP-SDS-G3/8E-IG1/4
G 3/8 A	G 1/2	PN 630	21.9	8	42.5	30	20	12	F	90	13.2	1149072000	GP-SDS-G3/8E-IG1/2
G 3/8 A	G 3/4	PN 400	21.9	8	45.5	36	22	12	F	90	19.1	1149062000	GP-SDS-G3/8E-IG3/4
G 1/2 A	G 1/8	PN 630	26.9	8.5	24	27	8	14	E	150	6.5	1149152000	GP-SDS-G1/2E-IG1/8
G 1/2 A	G 1/4	PN 630	26.9	11.5	24	27	12	14	E	150	5.6	1149142000	GP-SDS-G1/2E-IG1/4
G 1/2 A	G 3/8	PN 630	26.9	12	37.5	27	17	14	F	150	9.7	1149132000	GP-SDS-G1/2E-IG3/8
G 1/2 A	G 1/2	PN 630	26.9	12	42	30	20	14	F	150	12.3	1149402000	GP-SDS-G1/2E-IG1/2
G 1/2 A	G 3/4	PN 400	26.9	12	47.5	36	22	14	F	150	19.4	1149122000	GP-SDS-G1/2E-IG3/4
G 1/2 A	G 1	PN 400	26.9	12	50.5	41	24.5	14	F	150	23.7	1149112000	GP-SDS-G1/2E-IG1
G 1/2 A	G 1 1/4	PN 400	26.9	12	54.5	55	26.5	14	F	150	50.3	1149102000	GP-SDS-G1/2E-IG11/4
G 3/4 A	G 1/4	PN 400	31.9	11.5	26	32	12	16	E	200	10.1	1149212000	GP-SDS-G3/4E-IG1/4
G 3/4 A	G 3/8	PN 400	31.9	15	26	32	12	16	E	200	8.5	1149202000	GP-SDS-G3/4E-IG3/8
G 3/4 A	G 1/2	PN 400	31.9	16	42.5	32	20	16	F	200	15.0	1149192000	GP-SDS-G3/4E-IG1/2
G 3/4 A	G 1	PN 400	31.9	16	52.5	41	24.5	16	F	200	24.7	1149182000	GP-SDS-G3/4E-IG1
G 3/4 A	G 1 1/4	PN 400	31.9	16	56.5	55	26.5	16	F	200	51.4	1149172000	GP-SDS-G3/4E-IG11/4
G 3/4 A	G 1 1/2	PN 315	31.9	16	58.5	60	28.5	16	F	200	59.6	1149162000	GP-SDS-G3/4E-IG11/2



Thread reducing couplings

Both threads: Whitworth pipe thread, parallel

Sealing with PEFLEX profile seal ring

Standard profile seal ring material is NBR

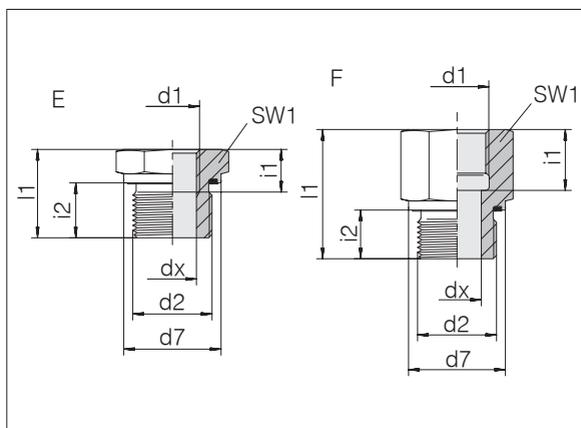

Male thread d2	Female thread d1	Pressure	d7	dx	l1	SW1	i1	i2	Form	Nm -10 %	kg/100 ca.	Order-No.	Designation
G 1 A	G 1/4	PN 400	39.9	11.5	29	41	12	18	E	250	19.3	1149272000	GP-SDS-G1E-IG1/4
G 1 A	G 3/8	PN 400	39.9	15	29	41	12	18	E	250	17.8	1149262000	GP-SDS-G1E-IG3/8
G 1 A	G 1/2	PN 400	39.9	19	29	41	14	18	E	250	15.2	1149252000	GP-SDS-G1E-IG1/2
G 1 A	G 3/4	PN 400	39.9	20	49	41	22	18	F	250	28.6	1149242000	GP-SDS-G1E-IG3/4
G 1 A	G 1 1/4	PN 400	39.9	20	59	55	26.5	18	F	250	54.9	1149232000	GP-SDS-G1E-IG11/4
G 1 A	G 1 1/2	PN 315	39.9	20	61	60	28.5	18	F	250	62.6	1149222000	GP-SDS-G1E-IG11/2
G 1 1/4 A	G 1/2	PN 400	49.9	19	32	50	14	20	E	500	30.9	1149312000	GP-SDS-G11/4E-IG1/2
G 1 1/4 A	G 3/4	PN 400	49.9	24	32	50	16	20	E	500	26.0	1149302000	GP-SDS-G11/4E-IG3/4
G 1 1/4 A	G 1	PN 400	49.9	25	54	50	24.5	20	F	500	48.2	1149292000	GP-SDS-G11/4E-IG1
G 1 1/4 A	G 1 1/2	PN 315	49.9	25	62	60	28.5	20	F	500	65.9	1149282000	GP-SDS-G11/4E-IG11/2
G 1 1/2 A	G 1/2	PN 315	54.9	19	36	55	14	22	E	600	46.7	1149352000	GP-SDS-G11/2E-IG1/2
G 1 1/2 A	G 3/4	PN 315	54.9	24	36	55	16	22	E	600	41.6	1149342000	GP-SDS-G11/2E-IG3/4
G 1 1/2 A	G 1	PN 315	54.9	30.5	36	55	18	22	E	600	33.6	1149332000	GP-SDS-G11/2E-IG1
G 1 1/2 A	G 1 1/4	PN 315	54.9	32	60	55	26.5	22	F	600	55.3	1149322000	GP-SDS-G11/2E-IG11/4
G 2 A	G 1/2	PN 160	74.9	19	45	75	14	24	E	700	117.1	1149682000	GP-SDS-G2E-IG1/2
G 2 A	G 1	PN 160	74.9	30.5	45	75	18	24	E	700	101.9	1149692000	GP-SDS-G2E-IG1
G 2 A	G 1 1/4	PN 160	74.9	39	45	75	26.5	24	E	700	85.2	1149702000	GP-SDS-G2E-IG11/4
G 2 A	G 1 1/2	PN 160	74.9	40	65	75	28.5	24	F	700	131.0	1149672000	GP-SDS-G2E-IG11/2

Straight adapter ISO 6149 / DIN 3852

Both threads: metric fine thread, parallel

Standard O-ring material is NBR

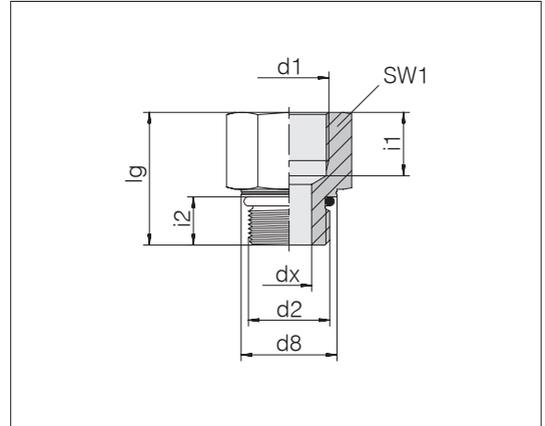

Male thread d2	Female thread d1	Pressure	d8	dx	lg	SW1	i1	i2	Nm -10 %	kg/100 ca.	Order-No.	Designation
M 10 x 1	M 10 x 1	PB 630	13.8	3	24	17	11	8.5	15	2.6	1149542000	GP-SDS-M10F-IM10
M 12 x 1.5	M 12 x 1.5	PB 630	16.8	4	31.5	19	16	11	25	4.4	1149552000	GP-SDS-M12F-IM12
M 14 x 1.5	M 14 x 1.5	PB 630	18.8	6	31.5	22	16	11	35	5.6	1149562000	GP-SDS-M14F-IM14
M 16 x 1.5	M 16 x 1.5	PB 630	21.8	7	33	24	16	11.5	40	7.1	1149572000	GP-SDS-M16F-IM16
M 18 x 1.5	M 18 x 1.5	PB 630	23.8	9	34	27	16	12.5	45	8.8	1149582000	GP-SDS-M18F-IM18
M 22 x 1.5	M 22 x 1.5	PB 630	26.8	12	37	32	18	13	60	13.0	1149592000	GP-SDS-M22F-IM22
M 27 x 2	M 26 x 1.5	PB 400	31.8	15	44	36	21	16	100	19.4	1149602000	GP-SDS-M27F-IM26
M 27 x 2	M 27 x 2	PB 400	31.8	15	44	36	21	16	100	19.0	1149612000	GP-SDS-M27F-IM27
M 33 x 2	M 33 x 2	PB 400	40.8	20	46	46	23	16	160	32.0	1149622000	GP-SDS-M33F-IM33
M 42 x 2	M 42 x 2	PB 250	49.8	26	49	55	25	16	210	46.7	1149632000	GP-SDS-M42F-IM42
M 48 x 2	M 48 x 2	PB 250	54.8	32	53.5	60	27	17.5	260	56.5	1149642000	GP-SDS-M48F-IM48

Blanking screws

For threaded holes according to DIN 3852 / ISO 9974

Thread: metric fine thread, parallel

Sealing with PEFLEX profile seal ring

Standard profile seal ring material is NBR

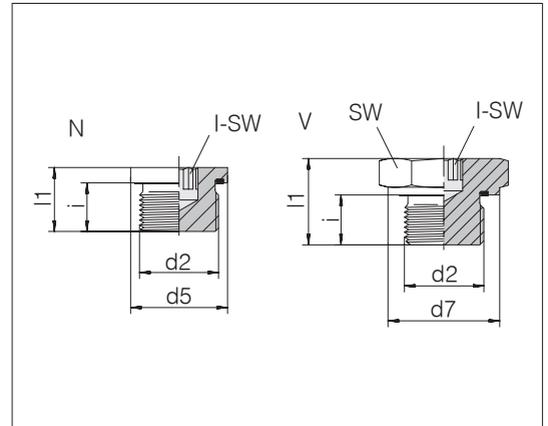

d2	Pressure	d5	d7	l1	SW	I-SW	i	Form	Nm -10 %	kg/100 ca.	Order-No.	Designation
M 8 x 1	PN 400	12		12.3		4	8	N	10	0.5	0189142100	GP-PLIH-M8E-C21
M 10 x 1	PN 400	14		12.3		5	8	N	12	0.7	0189202100	GP-PLIH-M10E-C21
M 10 x 1	PN 400		13.9	18	14		8	V	12	1.6	1189202100	GP-PLIH-M10E-C21
M 12 x 1.5	PN 400	17		17.3		6	12	N	23	1.4	0189212100	GP-PLIH-M12E-C21
M 14 x 1.5	PN 400	19		17.3		6	12	N	30	1.9	0189222100	GP-PLIH-M14E-C21
M 14 x 1.5	PN 400		18.9	22	19		12	V	30	3.4	1189222100	GP-PLIH-M14E-C21
M 16 x 1.5	PN 400	21.9		17.3		8	12	N	50	2.4	0189232100	GP-PLIH-M16E-C21
M 18 x 1.5	PN 400	23.9		17.3		8	12	N	65	3.2	0189242100	GP-PLIH-M18E-C21
M 18 x 1.5	PN 400		23.9	22	24		12	V	65	5.6	1189242100	GP-PLIH-M18E-C21
M 20 x 1.5	PN 400	25.9		19.3		10	14	N	75	4.0	0189252100	GP-PLIH-M20E-C21
M 22 x 1.5	PN 400	27		19.3		10	14	N	90	5.0	0189262100	GP-PLIH-M22E-C21
M 24 x 1.5	PN 400	29.9		19.3		12	14	N	90	5.8	0189272100	GP-PLIH-M24E-C21
M 26 x 1.5	PN 400	31.9		21.3		12	16	N	110	7.4	0189282100	GP-PLIH-M26E-C21
M 27 x 2	PN 400	32		21.3		12	16	N	130	7.7	0189292100	GP-PLIH-M27E-C21
M 33 x 2	PN 400	39.9		22.8		17	16	N	225	12.4	0189302100	GP-PLIH-M33E-C21
M 33 x 2	PN 400		46	33	46	17	18	V	250	27.4	1189302100	GP-PLIH-M33E-C21
M 42 x 2	PN 400		57	38	60	22	20	V	400	53.4	1189312100	GP-PLIH-M42E-C21
M 42 x 2	PN 315	49.9		22.8		22	16	N	310	18.6	0189312100	GP-PLIH-M42E-C21
M 48 x 2	PN 400		64	40	65	24	22	V	500	69.2	1189322100	GP-PLIH-M48E-C21
M 48 x 2	PN 315	55		22.8		24	16	N	380	24.4	0189322100	GP-PLIH-M48E-C21

Example for comp. :
VST18X1ED

Threaded holes as spec. in
DIN 3852, form X.
d5 = d4 narrow

Blanking screws

For threaded holes according to DIN 3852 / ISO 1179

Thread: Whitworth pipe thread, parallel

Sealing with PEFLEX profile seal ring

Standard profile seal ring material is NBR

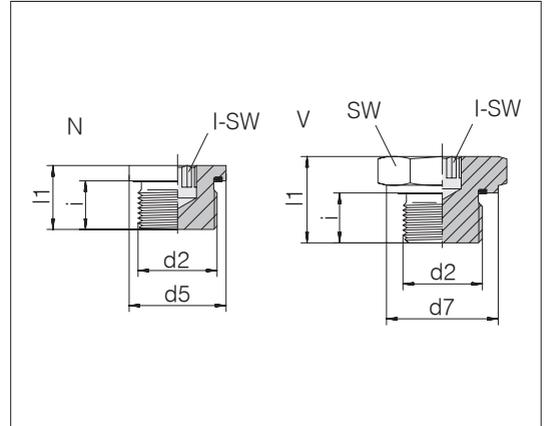

d2	Pressure	d5	d7	l1	SW	I-SW	i	Form	Nm -10 %	kg/100 ca.	Order-No.	Designation
G 1/8 A	PN 400	14		12.3		5	8	N	12	0.7	0189332100	GP-PLIH-G1/8E-C21
G 1/4 A	PN 400	18.9		17.3		6	12	N	25	1.8	0189342100	GP-PLIH-G1/4E-C21
G 3/8 A	PN 400	22		17.3		8	12	N	50	2.7	0189352100	GP-PLIH-G3/8E-C21
G 1/2 A	PN 400	26.9		19.3		10	14	N	70	4.4	0189362100	GP-PLIH-G1/2E-C21
G 3/4 A	PN 400	32		21.3		12	16	N	120	7.5	0189372100	GP-PLIH-G3/4E-C21
G 1 A	PN 400		46	33	46	17	18	V	250	27.2	0189382100	GP-PLIH-G1E-C21
G 1 A	PN 400	39.9		22.8		17	16	N	200	12.3	0189382100	GP-PLIH-G1E-C21
G 1 1/4 A	PN 400	49.9		28		22	20	N	450	27.2	1189412100	GP-PLIH-G11/4E-PN400-C21
G 1 1/4 A	PN 400		57	38	60	22	20	V	400	54.3	1189392100	GP-PLIH-G11/4E-C21
G 1 1/4 A	PN 315	49.9		22.8		22	16	N	320	19.4	0189392100	GP-PLIH-G11/4E-C21
G 1 1/2 A	PN 400	55		30		24	22	N	600	37.5	1189422100	GP-PLIH-G11/2E-PN400-C21
G 1 1/2 A	PN 400		64	40	65	24	22	V	500	69.3	1189402100	GP-PLIH-G11/2E-C21
G 1 1/2 A	PN 315	55		22.8		24	16	N	400	25.2	0189402100	GP-PLIH-G11/2E-C21

Example for comp. :
VST11/8ED

Threaded holes as spec. in
DIN 3852, form X.
d5 = d4 narrow



Blanking screws

Male thread: metric fine thread, parallel
ISO 6149

Sealing with O-ring

Standard O-ring material is NBR

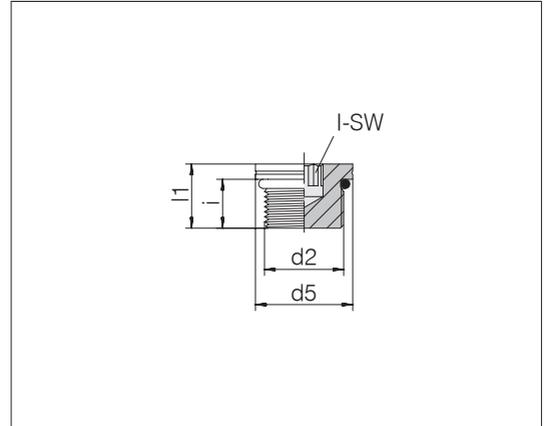

d2	Pressure	d5	l1	I-SW	i	Nm -10 %	kg/100 ca.	Order-No.	Designation
M 10 x 1	PN 630	14	13	5	9.5	18	0.8	0190012100	GP-PLIH-M10F-C21
M 12 x 1.5	PN 630	17	15.5	6	11	40	1.4	0190022100	GP-PLIH-M12F-C21
M 14 x 1.5	PN 630	19	16	6	11	55	2.0	0190032100	GP-PLIH-M14F-C21
M 16 x 1.5	PN 630	22	17.5	8	12.5	70	2.8	0190042100	GP-PLIH-M16F-C21
M 18 x 1.5	PN 630	24	19	8	14	90	3.9	0190052100	GP-PLIH-M18F-C21
M 22 x 1.5	PN 630	27	20	10	15	130	5.7	0190072100	GP-PLIH-M22F-C21
M 26 x 1.5	PN 400	31	21	12	16	150	8.0	0190102100	GP-PLIH-M26F-C21
M 27 x 2	PN 400	32	23.5	12	18.5	180	9.6	0190202100	GP-PLIH-M27F-C21
M 33 x 2	PN 400	41	24.5	17	18.5	310	15.1	0190182100	GP-PLIH-M33F-C21
M 42 x 2	PN 400	50	25	17	19	400	26.2	0190132100	GP-PLIH-M42F-C21
M 48 x 2	PN 400	55	27.5	17	21.5	500	37.9	0190142100	GP-PLIH-M48F-C21

Example for comp. :
VST110X10R

Blanking plugs

With sealing edge
fit in bore type W DIN 3861 / ISO 8434-1

For blind connections of tube couplings

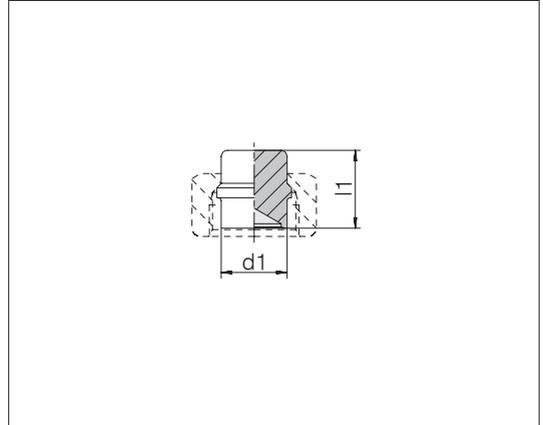

Series	Tube OD	Pressure	l1	kg/100 ca.	Order-No.	Designation
L/S	6	PN 315/630	19.5	0.5	0793652000	24-PLB-L/S6
L/S	8	PN 315/630	19.5	0.8	0793662000	24-PLB-L/S8
L/S	10	PN 315/630	21	1.3	0793672000	24-PLB-L/S10
L/S	12	PN 315/630	21.8	2.0	0793682000	24-PLB-L/S12
L	15	PN 315	22	3.0	0793692000	24-PLB-L15
L	18	PN 315	24	4.6	0793702000	24-PLB-L18
L	22	PN 160	26	7.4	0793712000	24-PLB-L22
L	28	PN 160	26.5	11.5	0793722000	24-PLB-L28
L	35	PN 160	32	22.1	0793732000	24-PLB-L35
L	42	PN 160	32.5	31.5	0793742000	24-PLB-L42
S	14	PN 630	23.5	2.9	0793792000	24-PLB-S14
S	16	PN 400	25.5	4.0	0793802000	24-PLB-S16
S	20	PN 400	30.5	7.4	0793812000	24-PLB-S20
S	25	PN 400	32.5	11.8	0793822000	24-PLB-S25
S	30	PN 400	35.5	18.3	0793832000	24-PLB-S30
S	38	PN 315	40	33.1	0793842000	24-PLB-S38

Example for comp. :
BUZ06LX



Blanking plugs

With taper and O-ring
fit in bore type W DIN 3861 / ISO 8434-1

For blind connections of tube couplings

Standard O-ring material is FPM/FKM

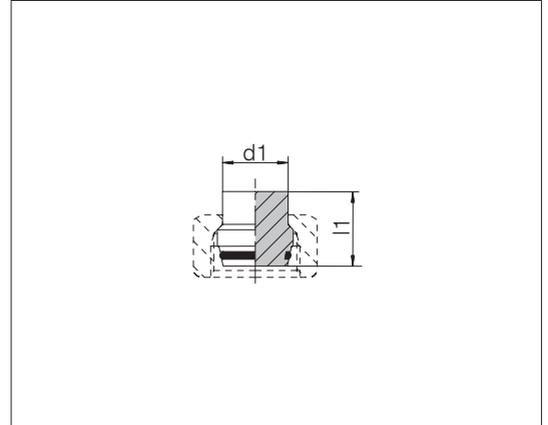

Series	Tube OD	Pressure	l1	kg/100 ca.	Order-No.	Designation
L/S	6	PN 500/800	18.5	0.6	1793142058	24-PLO-L/S6
L/S	8	PN 500/800	19	1.0	1793152058	24-PLO-L/S8
L/S	10	PN 500/800	21	1.6	1793162058	24-PLO-L/S10
L/S	12	PN 400/630	21.5	2.2	1793172058	24-PLO-L/S12
L	15	PN 400	20.5	3.2	1793082058	24-PLO-L15
L	18	PN 400	23.5	5.1	1793092058	24-PLO-L18
L	22	PN 250	26	8.1	1793102058	24-PLO-L22
L	28	PN 250	26.5	13.0	1793112058	24-PLO-L28
L	35	PN 250	32	24.0	1793122058	24-PLO-L35
L	42	PN 250	32.5	34.6	1793132058	24-PLO-L42
S	14	PN 630	24	3.2	1793182058	24-PLO-S14
S	16	PN 630	25	4.1	1793192058	24-PLO-S16
S	20	PN 420	30.5	8.0	1793202058	24-PLO-S20
S	25	PN 420	32.5	12.4	1793212058	24-PLO-S25
S	30	PN 420	35.5	18.2	1793222058	24-PLO-S30
S	38	PN 420	40.5	31.5	1793232058	24-PLO-S38

Example for comp. :
VKA06VIT

Blanking plugs

With taper and O-ring
fit in bore type W DIN 3861 / ISO 8434-1

For blind connections of tube couplings

Standard O-ring material is FPM/FKM

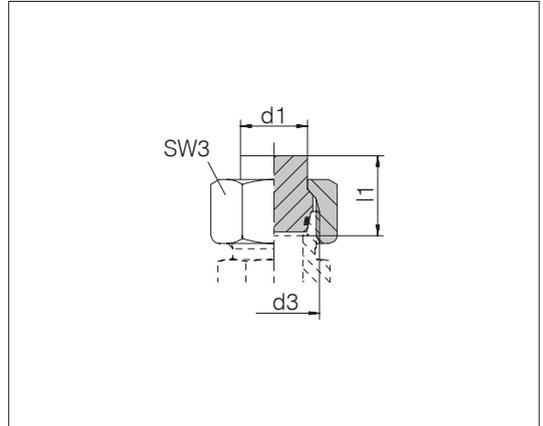

Series	d3	Pressure	l1	SW3	kg/100 ca.	Order-No.	Designation
Tube OD							
d1							
L 6	M 12 x 1.5	PN 500	18.5	14	1.6	1193042058	24-PLOC-L6
L 8	M 14 x 1.5	PN 500	19	17	2.5	1193052058	24-PLOC-L8
L 10	M 16 x 1.5	PN 500	21	19	3.4	1193062058	24-PLOC-L10
L 12	M 18 x 1.5	PN 400	21.5	22	4.8	1193072058	24-PLOC-L12
L 15	M 22 x 1.5	PN 400	20.5	27	7.5	1193082058	24-PLOC-L15
L 18	M 26 x 1.5	PN 400	23.5	32	11.4	1193092058	24-PLOC-L18
L 22	M 30 x 2	PN 250	26	36	16.3	1193102058	24-PLOC-L22
L 28	M 36 x 2	PN 250	26.5	41	21.7	1193112058	24-PLOC-L28
L 35	M 45 x 2	PN 250	32	50	37.4	1193122058	24-PLOC-L35
L 42	M 52 x 2	PN 250	32.5	60	55.9	1193132058	24-PLOC-L42
S 6	M 14 x 1.5	PN 800	18.5	17	2.4	1193142058	24-PLOC-S6
S 8	M 16 x 1.5	PN 800	19	19	3.1	1193152058	24-PLOC-S8
S 10	M 18 x 1.5	PN 800	21	22	4.7	1193162058	24-PLOC-S10
S 12	M 20 x 1.5	PN 630	21.5	24	5.7	1193172058	24-PLOC-S12
S 14	M 22 x 1.5	PN 630	24	27	8.5	1193182058	24-PLOC-S14
S 16	M 24 x 1.5	PN 630	25	30	10.7	1193192058	24-PLOC-S16
S 20	M 30 x 2	PN 420	30.5	36	18.3	1193202058	24-PLOC-S20
S 25	M 36 x 2	PN 420	32.5	46	33.0	1193212058	24-PLOC-S25
S 30	M 42 x 2	PN 420	35.5	50	39.8	1193222058	24-PLOC-S30
S 38	M 52 x 2	PN 420	40.5	60	62.8	1193232058	24-PLOC-S38

Example for comp. :
VKAM06LVIT



Tube blanking screws

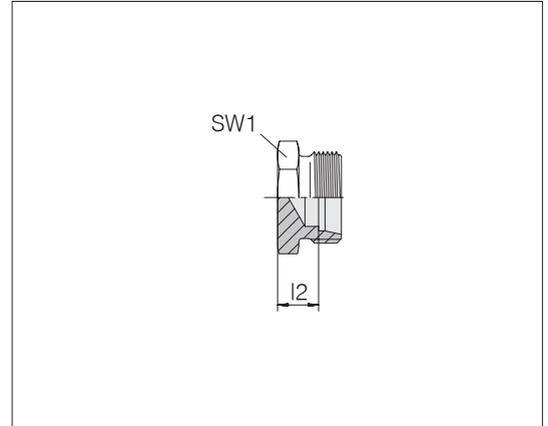

Series	Tube OD	Pressure	l2	SW1	kg/100 ca.	Order-No.	Designation
L	6	PN 315	7	12	0.8	0793342000	24-TBS-L6
L	8	PN 315	8	14	1.2	0793352000	24-TBS-L8
L	10	PN 315	9	17	1.6	0793362000	24-TBS-L10
L	12	PN 315	10	19	2.2	0793372000	24-TBS-L12
L	15	PN 315	11	24	3.8	0793382000	24-TBS-L15
L	18	PN 315	11.5	27	5.4	0793392000	24-TBS-L18
L	22	PN 160	13.5	32	7.7	0793402000	24-TBS-L22
L	28	PN 160	14.5	41	13.3	0793412000	24-TBS-L28
L	35	PN 160	14.5	46	20.1	0793422000	24-TBS-L35
L	42	PN 160	18.5	55	34.0	0793432000	24-TBS-L42
S	6	PN 630	11	14	1.6	0793442000	24-TBS-S6
S	8	PN 630	13	17	2.6	0793452000	24-TBS-S8
S	10	PN 630	12.5	19	3.1	0793462000	24-TBS-S10
S	12	PN 630	14.5	22	4.5	0793472000	24-TBS-S12
S	14	PN 630	16	24	5.9	0793482000	24-TBS-S14
S	16	PN 400	15.5	27	6.8	0793492000	24-TBS-S16
S	20	PN 400	17.5	32	12.0	0793502000	24-TBS-S20
S	25	PN 400	20	41	21.3	0793512000	24-TBS-S25
S	30	PN 400	20.5	46	28.1	0793522000	24-TBS-S30
S	38	PN 315	23	55	49.8	0793532000	24-TBS-S38

Example for comp. :
ROV06LX

Hexagonal nuts

For bulkhead couplings

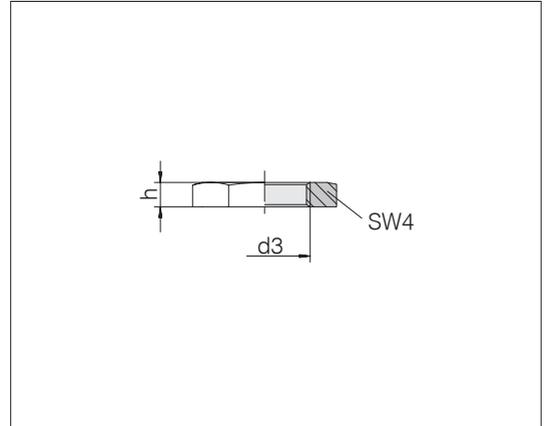

d3	SW4	h	kg/100 ca.	Order-No.	Designation
M 12 x 1.5	17	6	0.7	0081002100	24-LN-L6-IM12
M 14 x 1.5	19	6	0.8	0081022100	24-LN-L8-S6-IM14
M 16 x 1.5	22	6	1.0	0081042100	24-LN-L10-S8-IM16
M 18 x 1.5	24	6	1.2	0081062100	24-LN-L12-S10-IM18
M 20 x 1.5	27	6	1.5	0081082100	24-LN-S12-IM20
M 22 x 1.5	30	7	2.2	0081102100	24-LN-L15-S14-IM22
M 24 x 1.5	32	7	2.4	0081122100	24-LN-S16-IM24
M 26 x 1.5	36	8	3.8	0081142100	24-LN-L18-IM26
M 30 x 2	41	8	4.9	0081162100	24-LN-L22-S20-IM30
M 36 x 2	46	9	5.9	0081182100	24-LN-L28-S25-IM36
M 42 x 2	50	9	5.8	0081202100	24-LN-S30-IM42
M 45 x 2	55	9	7.5	0081222100	24-LN-L35-IM45
M 52 x 2	65	10	12.1	0081262100	24-LN-L42-S38-IM52

Example for comp. :
GM06LX
ISO 8434-1-LN-L6-St

Reinforcing sleeves

For thin-walled steel tubes

Material: brass

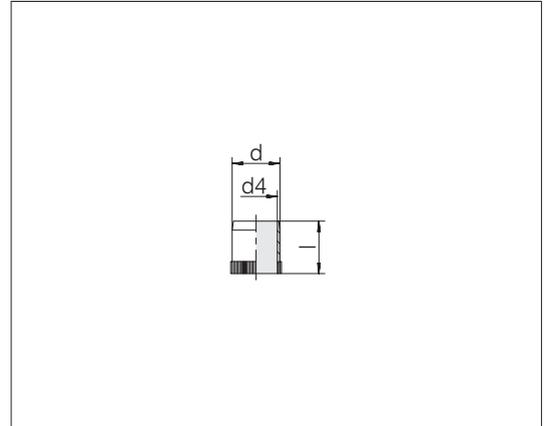

for tube OD x wall thickness	d	d4	l	kg/100 ca.	Order-No.	Designation
6 x 1	4	2.6	15.5	0.1	0020005000	24-RS-4-BS
6 x 0.75	4.5	3.1	12.5	0.1	0020025000	24-RS-4,5-BS
6 x 0.5	5	3.6	12.5	0.1	0020045000	24-RS-5-BS
8 x 1	6	4.6	15.5	0.2	0020085000	24-RS-6-BS
8 x 0.75	6.5	5.1	12.5	0.1	0020125000	24-RS-6,5-BS
10 x 1.5	7	5.6	17	0.2	0020145000	24-RS-7-BS
10 x 1	8	6.6	16.5	0.2	0020165000	24-RS-8-BS
10 x 0.75	8.5	7.1	16.5	0.2	0020185000	24-RS-8,5-BS
12 x 1.5	9	7.6	16.5	0.3	0020245000	24-RS-9-BS
12 x 1	10	8.6	16.5	0.3	0020285000	24-RS-10-BS
12 x 0.75	10.5	9.3	16.5	0.3	0020305000	24-RS-10,5-BS
14 x 1 / 15 x 1.5	12	10.2	17	0.5	0020345000	24-RS-12-BS
15 x 1 / 16 x 1.5	13	11.2	17	0.5	0020365000	24-RS-13-BS
18 x 1.5	15	13.2	17.5	0.6	0020385000	24-RS-15-BS
18 x 1 / 20 x 2	16	14.2	17.5	0.6	0020405000	24-RS-16-BS
20 x 1 / 22 x 2	18	16.2	22	0.9	0020425000	24-RS-18-BS
22 x 1.5	19	17.2	18	0.8	0020445000	24-RS-19-BS
22 x 1	20	18.2	18	0.8	0020465000	24-RS-20-BS
25 x 1.5	22	20.2	23.5	1.1	0020485000	24-RS-22-BS
25 x 1	23	21.2	23.5	1.2	0020505000	24-RS-23-BS
28 x 2	24	22.2	18	1.4	0020525000	24-RS-24-BS
28 x 1.5 / 30 x 2.5	25	23.2	18	0.9	0020545000	24-RS-25-BS
28 x 1 / 30 x 2	26	24.2	18	1.0	0020565000	24-RS-26-BS
35 x 2	31	28.8	22.5	1.9	0020585000	24-RS-31-BS
35 x 1.5 / 38 x 3	32	29.8	22.5	1.9	0020605000	24-RS-32-BS
42 x 2	38	35.8	23.5	2.4	0020645000	24-RS-38-BS
42 x 1.5	39	36.8	23.5	2.5	0020665000	24-RS-39-BS

Example for comp. :
VH04MSX

Reinforcing sleeves

For thin-walled steel tubes

Material: Steel

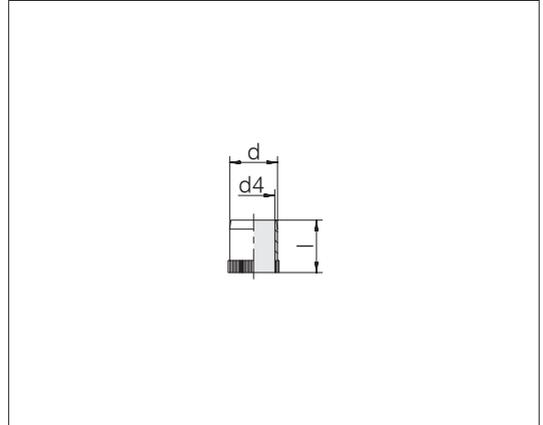

for tube OD x wall thickness	d	d4	l	kg/100 ca.	Order-No.	Designation
6 x 1	4	2.6	14	0.1	0020732000	24-RS-4-ST
6 x 0.75	4.5	3.1	14	0.1	0020742000	24-RS-4,5-ST
8 x 1	6	4.6	14	0.1	0020752000	24-RS-6-ST
10 x 1	8	6.6	16.5	0.2	0020772000	24-RS-8-ST
12 x 1	10	8.6	16.5	0.2	0020792000	24-RS-10-ST
14 x 1	12	10.1	17	0.4	0020812000	24-RS-12-ST
15 x 1 / 16 x 1.5	13	11.1	17	0.4	0020822000	24-RS-13-ST
16 x 1	14	12.1	17	0.4	0020832000	24-RS-14-ST
18 x 1.5	15	13.1	19	0.6	0020842000	24-RS-15-ST
18 x 1 / 20 x 2	16	14.1	19	0.6	0020852000	24-RS-16-ST
20 x 1.5	17	15.1	20	0.6	0020862000	24-RS-17-ST
22 x 2	18	16.1	20	0.6	0020872000	24-RS-18-ST
22 x 1.5	19	17.1	16	0.6	0020452000	24-RS-19-ST
22 x 1	20	18.1	20	0.8	0020882000	24-RS-20-ST
25 x 2	21	19.1	21.5	0.8	0020892000	24-RS-21-ST
25 x 1.5	22	20.1	23.5	1.0	0020902000	24-RS-22-ST
28 x 2	24	22.3	23.5	1.1	0020912000	24-RS-24-ST
28 x 1.5 / 30 x 2.5	25	23.3	23.5	0.9	0020532000	24-RS-25-ST
28 x 1 / 30 x 2	26	24.3	23.5	1.3	0020922000	24-RS-26-ST
35 x 2.5	30	27.6	26.5	1.9	0020932000	24-RS-30-ST
35 x 2	31	28.6	26.5	2.0	0020592000	24-RS-31-ST
35 x 1.5 / 38 x 3	32	29.6	26.5	1.9	0020942000	24-RS-32-ST
38 x 2.5	33	30.6	26.5	2.0	0020952000	24-RS-33-ST
38 x 2	34	31.6	26.5	2.6	0020962000	24-RS-34-ST
42 x 2.5	37	34.6	21	2.0	0020972000	24-RS-37-ST
42 x 2	38	35.6	21	2.0	0020982000	24-RS-38-ST
42 x 1.5	39	36.6	21	2.0	0020992000	24-RS-39-ST

Example for comp. :
VH04CFX



Reinforcing sleeves

For thin-walled stainless steel tubes

Material: Stainless steel

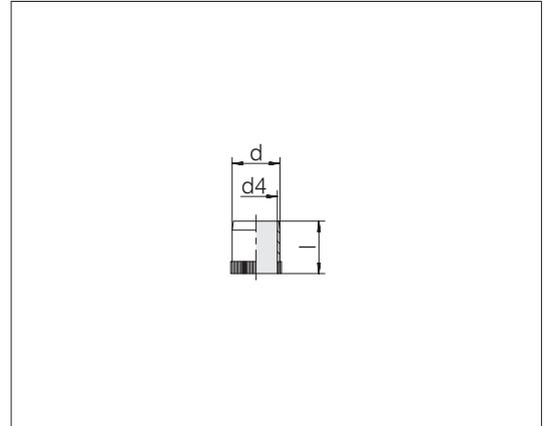

for tube OD x wall thickness	d	d4	l	kg/100 ca.	Order-No.	Designation
6 x 1	4	2.5	17	0.1	1020006000	24-RS-4-SST
8 x 1	6	4.5	14	0.1	1020016000	24-RS-6-SST
10 x 1	8	6.5	15.5	0.2	1020026000	24-RS-8-SST
12 x 1	10	8.5	15.5	0.2	1020036000	24-RS-10-SST
14 x 1	12	10.5	17	0.4	1020046000	24-RS-12-SST
15 x 1 / 16 x 1.5	13	11.5	17	0.4	1020056000	24-RS-13-SST
16 x 1	14	12	17	0.4	1020066000	24-RS-14-SST
18 x 1.5	15	13	18	0.6	1020076000	24-RS-15-SST
18 x 1 / 20 x 2	16	14	18	0.6	1020086000	24-RS-16-SST
20 x 1.5	17	15	20	0.6	1020096000	24-RS-17-SST
22 x 2	18	16	20	0.6	1020106000	24-RS-18-SST
22 x 1.5	19	17	20	0.6	1020116000	24-RS-19-SST
22 x 1	20	18	20	0.8	1020126000	24-RS-20-SST
25 x 2	21	19	21.5	0.8	1020136000	24-RS-21-SST
25 x 1.5	22	20	24	1.0	1020146000	24-RS-22-SST
28 x 2	24	22	23.5	1.1	1020156000	24-RS-24-SST
28 x 1.5 / 30 x 2.5	25	23	23.5	1.0	1020166000	24-RS-25-SST
28 x 1 / 30 x 2	26	24	23.5	1.3	1020176000	24-RS-26-SST
35 x 2.5	30	27.8	26.5	1.9	1020186000	24-RS-30-SST
35 x 2	31	28	26.5	2.0	1020196000	24-RS-31-SST
35 x 1.5 / 38 x 3	32	29.5	26.5	1.9	1020206000	24-RS-32-SST
38 x 2.5	33	30	26.5	2.0	1020216000	24-RS-33-SST
42 x 2	38	35	26.5	2.0	1020226000	24-RS-38-SST

Example for comp. :
VH0471X

Sealing rings

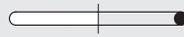
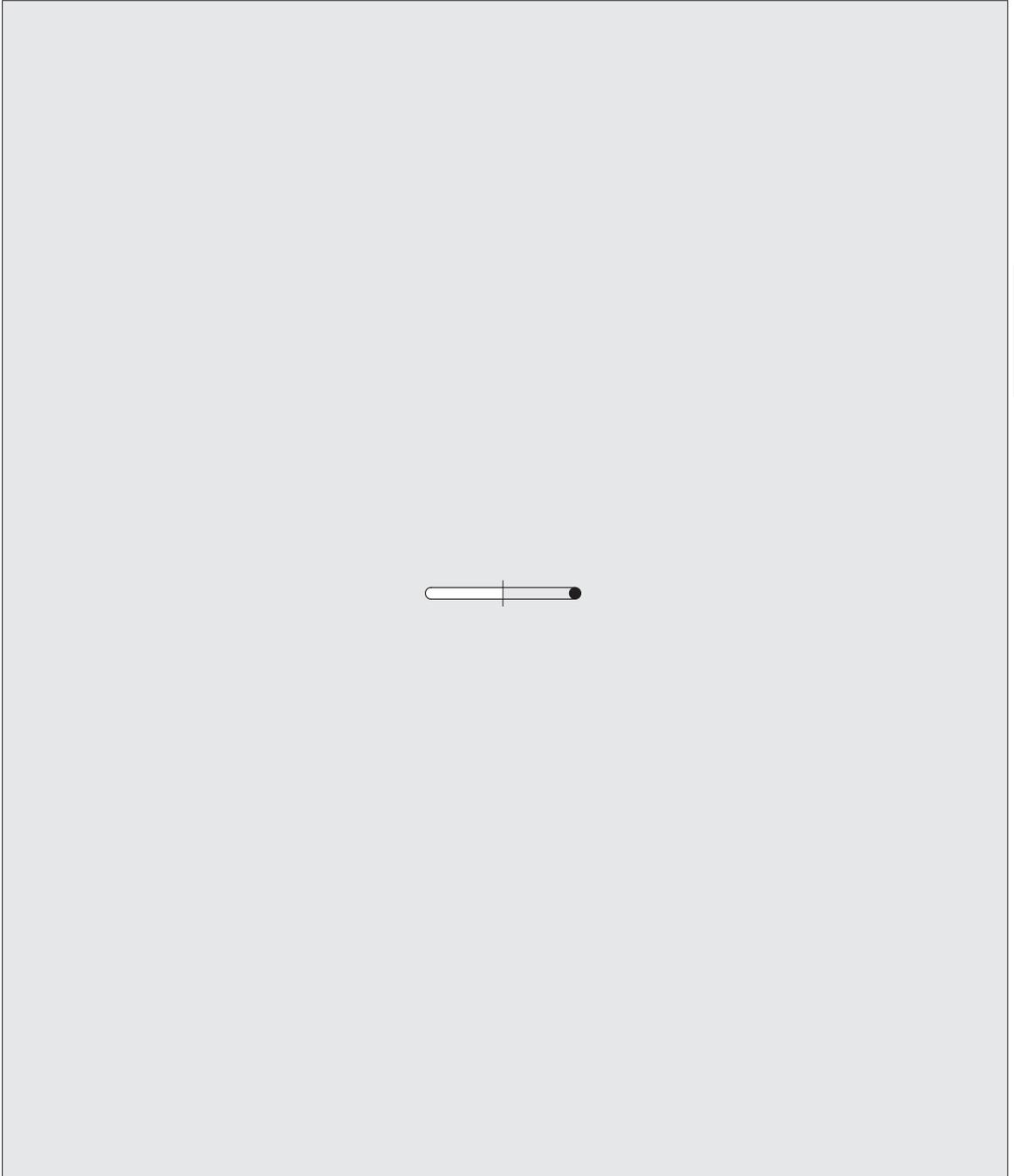

Sealing rings for ES-4 cutting rings

- O-Ring for inner sector
- Moulded seal for the outer cone

Standard material for moulded seals and O-rings is FPM/FKM

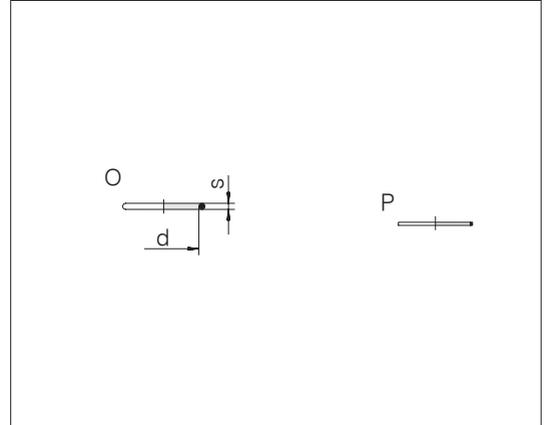

Series	d	s	Order-No.	Designation	Order-No.	Designation
Tube OD				O		P
L 6	6	1	0907329783	GP-ES4OR-6x1-FKM80	0912009783	GP-ES4MS-6-FKM80
L 8	8	1	0907609783	GP-ES4OR-8x1-FKM80	0912019783	GP-ES4MS-8-FKM80
L 10	10	1	0908909783	GP-ES4OR-10x1-FKM80	0912029783	GP-ES4MS-10-FKM80
L 12	12	1	0908919783	GP-ES4OR-12x1-FKM80	0912039783	GP-ES4MS-12-FKM80
L 15	15	1	0908889783	GP-ES4OR-15x1-FKM80	0912059783	GP-ES4MS-15-FKM80
L 18	18	1	0908989783	GP-ES4OR-18x1-FKM80	0912079783	GP-ES4MS-18-FKM80
L 22	22	1	0908999783	GP-ES4OR-22x1-FKM80	0912099783	GP-ES4MS-22-FKM80
L 28	28	1	0908879783	GP-ES4OR-28x1-FKM80	0912119783	GP-ES4MS-28-FKM80
L 35	35	1	0908869783	GP-ES4OR-35x1-FKM80	0912139783	GP-ES4MS-35-FKM80
L 42	42	1	0908859783	GP-ES4OR-42x1-FKM80	0912159783	GP-ES4MS-42-FKM80
S 6	6	1	0907329783	GP-ES4OR-6x1-FKM80	0912009783	GP-ES4MS-6-FKM80
S 8	8	1	0907609783	GP-ES4OR-8x1-FKM80	0912019783	GP-ES4MS-8-FKM80
S 10	10	1	0908909783	GP-ES4OR-10x1-FKM80	0912029783	GP-ES4MS-10-FKM80
S 12	12	1	0908919783	GP-ES4OR-12x1-FKM80	0912039783	GP-ES4MS-12-FKM80
S 14	14	1	0908929783	GP-ES4OR-14x1-FKM80	0912049783	GP-ES4MS-14-FKM80
S 16	16	1	0908939783	GP-ES4OR-16x1-FKM80	0912069783	GP-ES4MS-16-FKM80
S 20	20	1	0908949783	GP-ES4OR-20x1-FKM80	0912089783	GP-ES4MS-20-FKM80
S 25	25	1	0908959783	GP-ES4OR-25x1-FKM80	0912109783	GP-ES4MS-25-FKM80
S 30	30	1	0908969783	GP-ES4OR-30x1-FKM80	0912129783	GP-ES4MS-30-FKM80
S 38	38	1	0908979783	GP-ES4OR-38x1-FKM80	0912149783	GP-ES4MS-38-FKM80

Sealing rings (seal-edge rings for banjo and gauge couplings)

- Sealing-edge ring for banjo couplings for external thread (DS)
- Sealing-edge ring for gauge couplings for internal thread (DM)

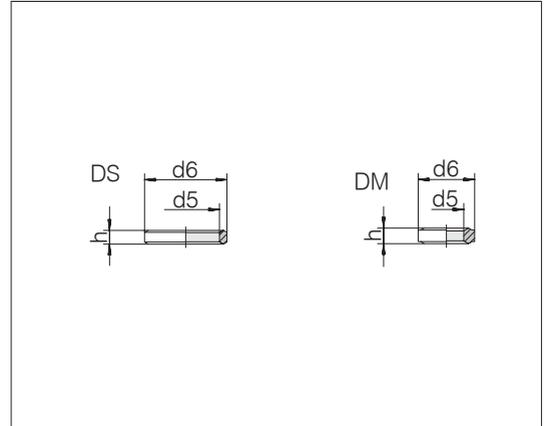

d2	d5	d6	h	Form	kg/100 ca.	Order-No.	Designation
M 8 x 1	8.1	12	2.5	DS	0.1	0080692100	GP-SR-M8B-H2,5-C21
M 10 x 1	10.1	14	2.5	DS	0.1	0080702100	GP-SR-M10B-H2,5-C21
M 12 x 1.5	12.1	17	3	DS	0.2	0080712100	GP-SR-M12B-H3-C21
M 14 x 1.5	14.1	19	3	DS	0.2	0080722100	GP-SR-M14B-H3-C21
M 16 x 1.5	16.1	21	3	DS	0.3	0080732100	GP-SR-M16B-H3-C21
M 18 x 1.5	18.1	23	3	DS	0.3	0080742100	GP-SR-M18B-H3-C21
M 20 x 1.5	20.1	25	3	DS	0.3	0080752100	GP-SR-M20B-H3-C21
M 22 x 1.5	22.1	27	4.5	DS	0.6	0080142100	GP-SR-M22B-H4,5-C21
M 26 x 1.5	26.15	31	3.5	DS	0.5	0080772100	GP-SR-M26B-H3,5-C21
M 27 x 2	27.15	32	3.5	DS	0.5	0080782100	GP-SR-M27B-H3,5-C21
M 33 x 2	33.15	39	3.5	DS	0.7	0080792100	GP-SR-M33B-H3,5-C21
M 42 x 2	42.15	49	3.5	DS	1.0	0080802100	GP-SR-M42B-H3,5-C21
M 48 x 2	48.15	55	3.5	DS	1.2	0080812100	GP-SR-M48B-H3,5-C21
G 1/8 A	9.8	14	2.5	DS	0.1	0080822100	GP-SR-G1/8B-H2,5-C21
G 1/4 A	5.8	11.2	4.6	DM	0.2	0080562100	GP-SR-IG1/4B-H4,6-C21
G 1/4 A	13.25	18	3	DS	0.2	0080832100	GP-SR-G1/4B-H3-C21
G 3/8 A	16.75	22	3	DS	0.3	0080842100	GP-SR-G3/8B-H3-C21
G 1/2 A	11	18.3	5.2	DM	0.6	0080582100	GP-SR-IG1/2B-H5,2-C21
G 1/2 A	21.1	26	4.5	DS	0.5	0080852100	GP-SR-G1/2B-H4,5-C21
G 3/4 A	26.6	32	3.5	DS	0.6	0080862100	GP-SR-G3/4B-H3,5-C21
G 1 A	33.4	39	3.5	DS	0.7	0080872100	GP-SR-G1B-H3,5-C21
G 1 1/4 A	42.05	49	3.5	DS	1.0	0080882100	GP-SR-G1 1/4B-H3,5-C21
G 1 1/2 A	48	55	3.5	DS	1.2	0080892100	GP-SR-G1 1/2B-H3,5-C21

Example for comp. :
DKA10X

Sealing rings for banjo couplings

Soft seal ring for eccentric banjo couplings for external thread

Standard soft seal ring material is NBR

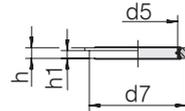

d2	d5	d7	h	h1	kg/100 ca.	Order-No.	Designation
M 10 x 1	10.2	14.9	2.5	1.1	0.2	0090509900	GP-SR-M10-G1/8E
M 12 x 1.5	12.2	17	3	1.6	0.2	0090519900	GP-SR-M12E
M 14 x 1.5	14.2	18.9	3	1.6	0.2	0090529900	GP-SR-M14-G1/4E
M 16 x 1.5	16.9	21.9	3	2.1	0.3	0090539900	GP-SR-M16-G3/8E
M 18 x 1.5	18.2	23.9	3		0.4	0090549900	GP-SR-M18E
M 22 x 1.5	22.2	26.9	4.5	2.6	0.7	0090569900	GP-SR-M22-G1/2E
M 26 x 1.5	26.2	31.9	3.5	2.6	0.6	0090579900	GP-SR-M26E
M 27 x 2	27.2	32.9	3.5	2.6	0.7	0090589900	GP-SR-M27-G3/4E
M 33 x 2	33.5	39.9	3.5	2.6	0.9	0090599900	GP-SR-M33-G1E
M 42 x 2	42.3	49.9	3.5		1.2	0090609900	GP-SR-M42-G11/4E
M 48 x 2	48.3	55.9	3.5	2.6	1.6	0090619900	GP-SR-M48-G11/2E
G 1/8 A	10.2	14.9	2.5	1.1	0.2	0090509900	GP-SR-M10-G1/8E
G 1/4 A	14.2	18.9	3	1.6	0.2	0090529900	GP-SR-M14-G1/4E
G 3/8 A	16.9	21.9	3	2.1	0.3	0090539900	GP-SR-M16-G3/8E
G 1/2 A	22.2	26.9	4.5	2.6	0.7	0090569900	GP-SR-M22-G1/2E
G 3/4 A	27.2	32.9	3.5	2.6	0.7	0090589900	GP-SR-M27-G3/4E
G 1 A	33.5	39.9	3.5	2.6	0.9	0090599900	GP-SR-M33-G1E
G 1 1/4 A	42.3	49.9	3.5		1.2	0090609900	GP-SR-M42-G11/4E
G 1 1/2 A	48.3	55.9	3.5	2.6	1.6	0090619900	GP-SR-M48-G11/2E

Example for comp. :
KDS10X

Sealing rings for banjo couplings

O-ring for hollow screws on eccentric banjo couplings

standard O-ring material is NBR

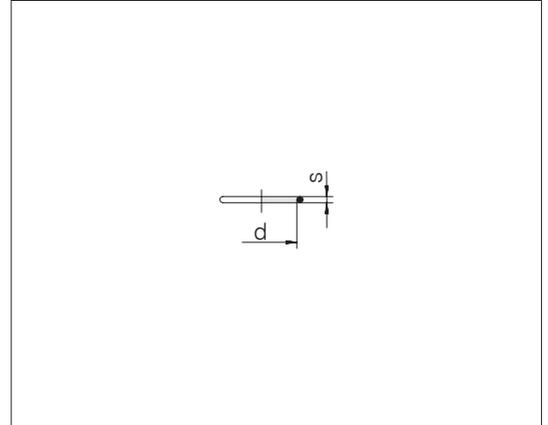

d2	O-ring d x s	Order-No.	Designation
M 10 x 1	8 x 1.5	0900049990	GP-OR-8x1,5-NBR90
M 12 x 1.5	10.5 x 1.5	0907529990	GP-OR-10,5x1,5-NBR90
M 14 x 1.5	12.5 x 1.5	0907649990	GP-OR-12,5x1,5-NBR90
M 16 x 1.5	14 x 1.5	0906029990	GP-OR-14x1,5-NBR90
M 18 x 1.5	16 x 1.5	0906629990	GP-OR-16x1,5-NBR90
M 22 x 1.5	20 x 1.5	0907659990	GP-OR-20x1,5-NBR90
M 26 x 1.5	23 x 2	0900909990	GP-OR-23x2-NBR90
M 27 x 2	24 x 2	0907539990	GP-OR-24x2-NBR90
M 33 x 2	29 x 2.5	0906639990	GP-OR-29x2,5-NBR90
M 42 x 2	38 x 2.5	0900949990	GP-OR-38x2,5-NBR90
M 48 x 2	43 x 3	0900789990	GP-OR-43x3-NBR90
G 1/8 A	8 x 1.5	0900049990	GP-OR-8x1,5-NBR90
G 1/4 A	12.5 x 1.5	0907649990	GP-OR-12,5x1,5-NBR90
G 3/8 A	15 x 1.5	0900889990	GP-OR-15x1,5-NBR90
G 1/2 A	19 x 1.5	0900899990	GP-OR-19x1,5-NBR90
G 3/4 A	24 x 2	0907539990	GP-OR-24x2-NBR90
G 1 A	29 x 2.5	0906639990	GP-OR-29x2,5-NBR90
G 1 1/4 A	38 x 2.5	0900949990	GP-OR-38x2,5-NBR90
G 1 1/2 A	43 x 3	0900789990	GP-OR-43x3-NBR90

Sealing rings for threaded studs

ISO 1179-2
ISO 9974-2

Standard profile seal ring material is NBR

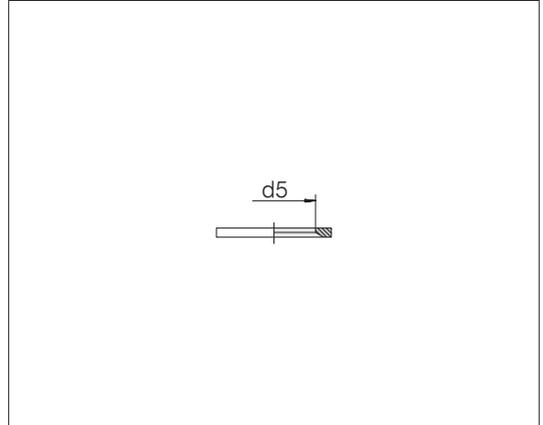

Thread d2	PEFLEX d5	Order-No.	Designation
M 10 x 1	8.4	0905229900	GP-PEFLEX-M10-G1/8-NBR85
M 12 x 1.5	9.8	0905019900	GP-PEFLEX-M12-NBR85
M 14 x 1.5	11.6	0905029900	GP-PEFLEX-M14-G1/4-NBR85
M 16 x 1.5	13.8	0905039900	GP-PEFLEX-M16-NBR85
M 18 x 1.5	15.7	0905059900	GP-PEFLEX-M18-NBR85
M 20 x 1.5	17.8	0905069900	GP-PEFLEX-M20-NBR85
M 22 x 1.5	19.6	0905089900	GP-PEFLEX-M22-NBR85
M 26 x 1.5	23.9	0905109900	GP-PEFLEX-M26-M27-G3/4-NBR85
M 27 x 2	23.9	0905109900	GP-PEFLEX-M26-M27-G3/4-NBR85
M 33 x 2	29.7	0905119900	GP-PEFLEX-M33-G1-NBR85
M 42 x 2	38.8	0905129900	GP-PEFLEX-M42-G1 1/4-NBR85
M 48 x 2	44.7	0905139900	GP-PEFLEX-M48-G1 1/2-NBR85
G 1/8 A	8.4	0905229900	GP-PEFLEX-M10-G1/8-NBR85
G 1/4 A	11.6	0905029900	GP-PEFLEX-M14-G1/4-NBR85
G 3/8 A	14.7	0905049900	GP-PEFLEX-G3/8-NBR85
G 1/2 A	18.5	0905079900	GP-PEFLEX-G1/2-NBR85
G 3/4 A	23.9	0905109900	GP-PEFLEX-M26-M27-G3/4-NBR85
G 1 A	29.7	0905119900	GP-PEFLEX-M33-G1-NBR85
G 1 1/4 A	38.8	0905129900	GP-PEFLEX-M42-G1 1/4-NBR85
G 1 1/2 A	44.7	0905139900	GP-PEFLEX-M48-G1 1/2-NBR85
G 2 A	56.7	0905149900	GP-PEFLEX-M60-G2-NBR80

Example for comp. :
ED10X1X

Sealing rings for threaded studs

ISO 1179-2
ISO 9974-2

Alternative profile seal ring material is FPM/FKM

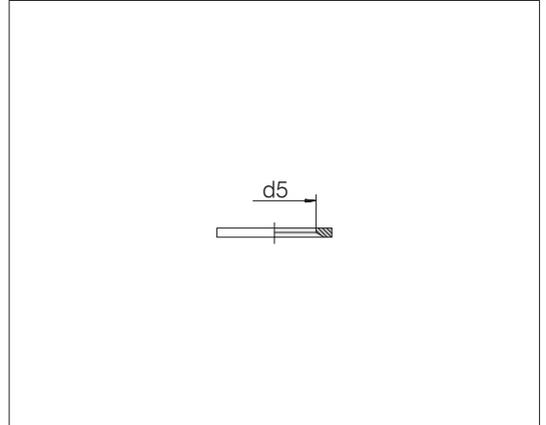

Thread d2	PEFLEX d5	Order-No.	Designation
M 10 x 1	8.4	0905229700	GP-PEFLEX-M10-G1/8-FKM80
M 12 x 1.5	9.8	0905019700	GP-PEFLEX-M12-FKM80
M 14 x 1.5	11.6	0905029700	GP-PEFLEX-M14-G1/4-FKM80
M 16 x 1.5	13.8	0905039700	GP-PEFLEX-M16-FKM80
M 18 x 1.5	15.7	0905059700	GP-PEFLEX-M18-FKM80
M 20 x 1.5	17.8	0905069700	GP-PEFLEX-M20-FKM80
M 22 x 1.5	19.6	0905089700	GP-PEFLEX-M22-FKM80
M 26 x 1.5	23.9	0905109700	GP-PEFLEX-M26-M27-G3/4-FKM80
M 27 x 2	23.9	0905109700	GP-PEFLEX-M26-M27-G3/4-FKM80
M 33 x 2	29.7	0905119700	GP-PEFLEX-M33-G1-FKM80
M 42 x 2	38.8	0905129700	GP-PEFLEX-M42-G11/4-FKM80
M 48 x 2	44.7	0905139700	GP-PEFLEX-M48-G11/2-FKM80
G 1/8 A	8.4	0905229700	GP-PEFLEX-M10-G1/8-FKM80
G 1/4 A	11.6	0905029700	GP-PEFLEX-M14-G1/4-FKM80
G 3/8 A	14.7	0905049700	GP-PEFLEX-G3/8-FKM80
G 1/2 A	18.5	0905079700	GP-PEFLEX-G1/2-FKM80
G 3/4 A	23.9	0905109700	GP-PEFLEX-M26-M27-G3/4-FKM80
G 1 A	29.7	0905119700	GP-PEFLEX-M33-G1-FKM80
G 1 1/4 A	38.8	0905129700	GP-PEFLEX-M42-G11/4-FKM80
G 1 1/2 A	44.7	0905139700	GP-PEFLEX-M48-G11/2-FKM80
G 2 A	56.7	0905149700	GP-PEFLEX-M60-G2-FKM80

Example for comp. :
ED10X1X

Sealing rings for threaded studs

ISO 1179-2
ISO 9974-2

Alternative profile seal ring material is EPDM

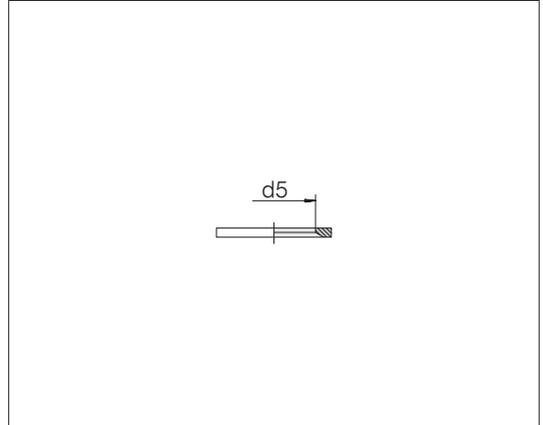

Thread d2	PEFLEX d5	Order-No.	Designation
M 10 x 1	8.4	0905229676	GP-PEFLEX-M10-G1/8-EPDM85
M 12 x 1.5	9.8	0905019676	GP-PEFLEX-M12-EPDM85
M 14 x 1.5	11.6	0905029676	GP-PEFLEX-M14-G1/4-EPDM85
M 16 x 1.5	13.8	0905039676	GP-PEFLEX-M16-EPDM85
M 18 x 1.5	15.7	0905059676	GP-PEFLEX-M18-EPDM85
M 20 x 1.5	17.8	0905069676	GP-PEFLEX-M20-EPDM85
M 22 x 1.5	19.6	0905089676	GP-PEFLEX-M22-EPDM85
M 26 x 1.5	23.9	0905109676	GP-PEFLEX-M26-M27-G3/4-EPDM85
M 27 x 2	23.9	0905109676	GP-PEFLEX-M26-M27-G3/4-EPDM85
M 33 x 2	29.7	0905119676	GP-PEFLEX-M33-G1-EPDM85
M 42 x 2	38.8	0905129676	GP-PEFLEX-M42-G11/4-EPDM85
M 48 x 2	44.7	0905139676	GP-PEFLEX-M48-G11/2-EPDM85
G 1/8 A	8.4	0905229676	GP-PEFLEX-M10-G1/8-EPDM85
G 1/4 A	11.6	0905029676	GP-PEFLEX-M14-G1/4-EPDM85
G 3/8 A	14.7	0905049676	GP-PEFLEX-G3/8-EPDM85
G 1/2 A	18.5	0905079676	GP-PEFLEX-G1/2-EPDM85
G 3/4 A	23.9	0905109676	GP-PEFLEX-M26-M27-G3/4-EPDM85
G 1 A	29.7	0905119676	GP-PEFLEX-M33-G1-EPDM85
G 1 1/4 A	38.8	0905129676	GP-PEFLEX-M42-G11/4-EPDM85
G 1 1/2 A	44.7	0905139676	GP-PEFLEX-M48-G11/2-EPDM85

Example for comp. :
ED10X1X

Sealing rings for threaded studs

ISO 6149-2 / -3
ISO 11926-2 / -3

Standard O-ring material is NBR

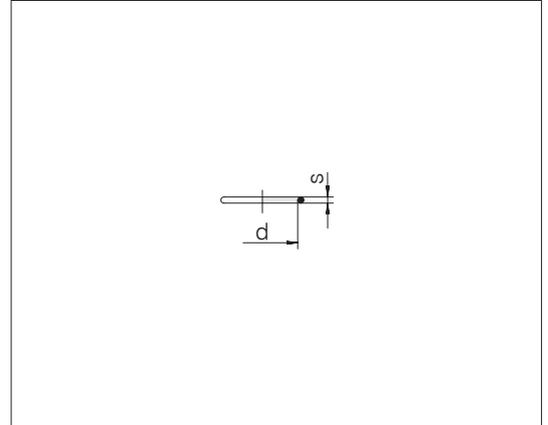

Thread d2	O-ring d x s	Order-No.	Designation
M 10 x 1	8.1 x 1.6	0908289990	GP-OR-8,1x1,6-NBR90
M 12 x 1.5	9.3 x 2.2	0908299990	GP-OR-9,3x2,2-NBR90
M 14 x 1.5	11.3 x 2.2	0908309990	GP-OR-11,3x2,2-NBR90
M 16 x 1.5	13.3 x 2.2	0908319990	GP-OR-13,3x2,2-NBR90
M 18 x 1.5	15.3 x 2.2	0908329990	GP-OR-15,3x2,2-NBR90
M 22 x 1.5	19.3 x 2.2	0908339990	GP-OR-19,3x2,2-NBR90
M 27 x 2	23.6 x 2.9	0908349990	GP-OR-23,6x2,9-NBR90
M 33 x 2	29.6 x 2.9	0908359990	GP-OR-29,6x2,9-NBR90
M 42 x 2	38.6 x 2.9	0908369990	GP-OR-38,6x2,9-NBR90
M 48 x 2	44.6 x 2.9	0908379990	GP-OR-44,6x2,9-NBR90
7/16-20 UNF-2A	8.92 x 1.83	0900249990	GP-OR-8,92x1,83-NBR90
1/2-20 UNF-2A	10.52 x 1.83	0900259990	GP-OR10,52x1,83-NBR90
9/16-18 UNF-2A	11.89 x 1.98	0900269990	GP-OR-11,89x1,98-NBR90
3/4-16 UNF-2A	16.36 x 2.21	0900279990	GP-OR-16,36x2,21-NBR90
7/8-14 UNF-2A	19.18 x 2.46	0900289990	GP-OR-19,18x2,46-NBR90
1 1/16-12 UN-2A	23.47 x 2.95	0900299990	GP-OR-23,47x2,95-NBR90
1 3/16-12 UN-2A	26.62 x 2.95	0900309990	GP-OR26,62x2,95-NBR90
1 5/16-12 UN-2A	29.74 x 2.95	0900319990	GP-OR-29,74x2,95-NBR90
1 5/8-12 UN-2A	37.47 x 3	0900329990	GP-OR-37,47x3-NBR90
1 7/8-12 UN-2A	43.69 x 3	0900339990	GP-OR43,69x3-NBR90

Sealing rings for threaded studs

ISO 6149-2 / -3
ISO 11926-2 / -3

Alternative O-ring material is FPM/FKM

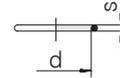

Thread d2	O-ring d x s	Order-No.	Designation
M 10 x 1	8.1 x 1.6	0908289780	GP-OR-8,1x1,6-FKM80
M 12 x 1.5	9.3 x 2.2	0908299780	GP-OR-9,3x2,2-FKM80
M 14 x 1.5	11.3 x 2.2	0908309780	GP-OR-11,3x2,2-FKM80
M 16 x 1.5	13.3 x 2.2	0908319780	GP-OR-13,3x2,2-FKM80
M 18 x 1.5	15.3 x 2.2	0908329780	GP-OR-15,3x2,2-FKM80
M 22 x 1.5	19.3 x 2.2	0908339780	GP-OR-19,3x2,2-FKM80
M 33 x 2	29.6 x 2.9	0908359780	GP-OR-29,6x2,9-FKM80
M 42 x 2	38.6 x 2.9	0908369780	GP-OR-38,6x2,9-FKM80
M 48 x 2	44.6 x 2.9	0908379780	GP-OR-44,6x2,9-FKM80
7/16-20 UNF-2A	8.92 x 1.83	0900249700	GP-OR-8,92x1,83-FKM80
1/2-20 UNF-2A	10.52 x 1.83	0900259700	GP-OR10,52x1,83-FKM80
9/16-18 UNF-2A	11.89 x 1.98	0900269700	GP-OR-11,89x1,98-FKM80
3/4-16 UNF-2A	16.36 x 2.21	0900279700	GP-OR-16,36x2,21-FKM80
7/8-14 UNF-2A	19.18 x 2.46	0900289700	GP-OR-19,18x2,46-FKM80
1 1/16-12 UN-2A	23.47 x 2.95	0900299700	GP-OR-23,47x2,95-FKM80
1 3/16-12 UN-2A	26.62 x 2.95	0900309700	GP-OR26,62x2,95-FKM80
1 5/16-12 UN-2A	29.74 x 2.95	0900319700	GP-OR-29,74x2,95-FKM80
1 5/8-12 UN-2A	37.47 x 3	0900329700	GP-OR-37,47x3-FKM80
1 7/8-12 UN-2A	43.69 x 3	0900339700	GP-OR43,69x3-FKM80

Sealing rings for conical seals (DKO), flared cone and welded cone couplings

Standard material for O-rings for flared cone and welded cone couplings is NBR

Alternative material for O rings for DKO couplings is NBR

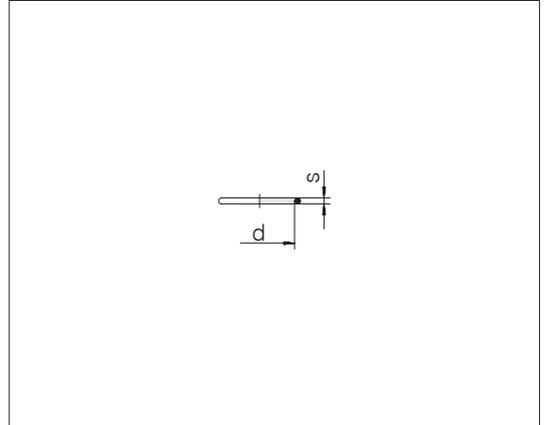

Series	Tube OD	d x s	Order-No.	Designation
L	6	4 x 1.5	0900009900	GP-OR-4x1,5-NBR80
L	8	6 x 1.5	0900029900	GP-OR-6x1,5-NBR80
L	10	7.5 x 1.5	0900419900	GP-OR-7,5x1,5-NBR80
L	12	9 x 1.5	0900429900	GP-OR-9x1,5-NBR80
L	15	12 x 2	0900449900	GP-OR-12x2-NBR80
L	18	15 x 2	0900389900	GP-OR-15x2-NBR80
L	22	20 x 2	0906199900	GP-OR-20x2-NBR80
L	28	26 x 2	0906589900	GP-OR-26x2-NBR80
L	35	32 x 2.5	0900929900	GP-OR-32x2,5-NBR80
L	42	38 x 2.5	0900949900	GP-OR-38x2,5-NBR80
S	6	4 x 1.5	0900009900	GP-OR-4x1,5-NBR80
S	8	6 x 1.5	0900029900	GP-OR-6x1,5-NBR80
S	10	7.5 x 1.5	0900419900	GP-OR-7,5x1,5-NBR80
S	12	9 x 1.5	0900429900	GP-OR-9x1,5-NBR80
S	14	10 x 2	0900439900	GP-OR-10x2-NBR80
S	16	12 x 2	0900449900	GP-OR-12x2-NBR80
S	20	16.3 x 2.4	0900459900	GP-OR-16,3x2,4-NBR80
S	25	20.3 x 2.4	0900469900	GP-OR-20,3x2,4-NBR80
S	30	25.3 x 2.4	0900479900	GP-OR-25,3x2,4-NBR80
S	38	33.3 x 2.4	0900489900	GP-OR-33,3x2,4-NBR80

Sealing rings for conical seals (DKO), flared cone and welded cone couplings

Standard material for O-rings for DKO couplings is FPM/FKM

Alternative material for O-rings for flared cone and welded cone couplings is FPM/FKM

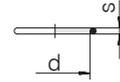

Series	d x s	Order-No.	Designation
Tube OD			
L 6	4 x 1.5	0900009700	GP-OR-4x1,5-FKM80
L 8	6 x 1.5	0900029700	GP-OR-6x1,5-FKM80
L 10	7.5 x 1.5	0900419700	GP-OR-7,5x1,5-FKM80
L 12	9 x 1.5	0900429700	GP-OR-9x1,5-FKM80
L 15	12 x 2	0900449700	GP-OR-12x2-FKM80
L 18	15 x 2	0900389700	GP-OR-15x2-FKM80
L 22	20 x 2	0906199700	GP-OR-20x2-FKM80
L 28	26 x 2	0906589700	GP-OR-26x2-FKM80
L 35	32 x 2.5	0900929700	GP-OR-32x2,5-FKM80
L 42	38 x 2.5	0900949700	GP-OR-38x2,5-FKM80
S 6	4 x 1.5	0900009700	GP-OR-4x1,5-FKM80
S 8	6 x 1.5	0900029700	GP-OR-6x1,5-FKM80
S 10	7.5 x 1.5	0900419700	GP-OR-7,5x1,5-FKM80
S 12	9 x 1.5	0900429700	GP-OR-9x1,5-FKM80
S 14	10 x 2	0900439700	GP-OR-10x2-FKM80
S 16	12 x 2	0900449700	GP-OR-12x2-FKM80
S 20	16.3 x 2.4	0900459700	GP-OR-16,3x2,4-FKM70
S 25	20.3 x 2.4	0900469700	GP-OR-20,3x2,4-FKM80
S 30	25.3 x 2.4	0900479700	GP-OR-25,3x2,4-FKM80
S 38	33.3 x 2.4	0900489700	GP-OR-33,3x2,4-FKM80

Sealing rings for conical seals (DKO), flared cone and welded cone couplings

Alternative O-ring material is EPDM

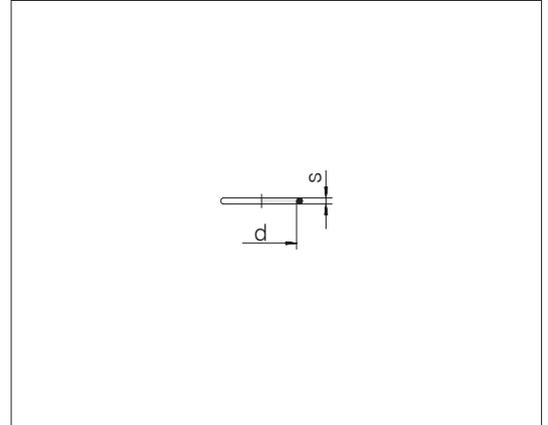

Series	Tube OD	d x s	Order-No.	Designation
L	6	4 x 1.5	0900009676	GP-OR-4x1,5-EPDM80
L	8	6 x 1.5	0900029676	GP-OR-6x1,5-EPDM80
L	10	7.5 x 1.5	0900419676	GP-OR-7,5x1,5-EPDM80
L	12	9 x 1.5	0900429676	GP-OR-9x1,5-EPDM80
L	15	12 x 2	0900449676	GP-OR-12x2-EPDM80
L	18	15 x 2	0900389676	GP-OR-15x2-EPDM80
L	22	20 x 2	0906199676	GP-OR-20x2-EPDM80
L	28	26 x 2	0906589676	GP-OR-26x2-EPDM80
L	35	32 x 2.5	0900929676	GP-OR-32x2,5-EPDM80
L	42	38 x 2.5	0900949676	GP-OR-38x2,5-EPDM80
S	6	4 x 1.5	0900009676	GP-OR-4x1,5-EPDM80
S	8	6 x 1.5	0900029676	GP-OR-6x1,5-EPDM80
S	10	7.5 x 1.5	0900419676	GP-OR-7,5x1,5-EPDM80
S	12	9 x 1.5	0900429676	GP-OR-9x1,5-EPDM80
S	14	10 x 2	0900439676	GP-OR-10x2-EPDM80
S	16	12 x 2	0900449676	GP-OR-12x2-EPDM80
S	20	16.3 x 2.4	0900459676	GP-OR-16,3x2,4-EPDM80
S	25	20.3 x 2.4	0900469676	GP-OR-20,3x2,4-EPDM80
S	30	25.3 x 2.4	0900479676	GP-OR-25,3x2,4-EPDM80
S	38	33.3 x 2.4	0900489676	GP-OR-33,3x2,4-EPDM80

Sealing rings for flange couplings

Standard O-ring material is NBR

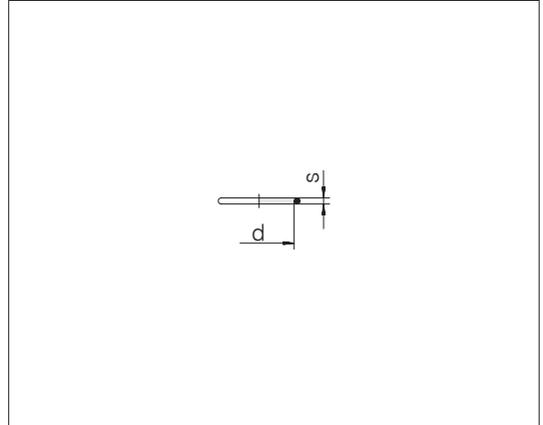

Series Tube OD	Hole circle diameter	Fl. size	d x s	Order-No.	Designation
L 10	35		20 x 2.5	0906599990	GP-OR-20x2,5-NBR90
L 12	35		20 x 2.5	0906599990	GP-OR-20x2,5-NBR90
L 15	35		20 x 2.5	0906599990	GP-OR-20x2,5-NBR90
L 15	40		26 x 2.5	0900189990	GP-OR-26x2,5-NBR90
L 18	40		26 x 2.5	0900189990	GP-OR-26x2,5-NBR90
L 18		3/4	24.99 x 3.53	0906719990	GP-OR-24,99x3,53-NBR90
L 22	40		26 x 2.5	0900189990	GP-OR-26x2,5-NBR90
L 22		3/4	24.99 x 3.53	0906719990	GP-OR-24,99x3,53-NBR90
L 28		1	32.92 x 3.53	0906729990	GP-OR-32,92x3,53-NBR90
L 28	40		26 x 2.5	0900189990	GP-OR-26x2,5-NBR90
L 28	55		32 x 2.5	0900929990	GP-OR-32x2,5-NBR90
L 35		1 1/4	37.69 x 3.53	0906739990	GP-OR-37,69x3,53-NBR90
L 35	55		32 x 2.5	0900929990	GP-OR-32x2,5-NBR90
L 42		1 1/2	47.22 x 3.53	0906549990	GP-OR-47,22x3,53-NBR90
S 12	35		20 x 2.5	0906599990	GP-OR-20x2,5-NBR90
S 16	35		20 x 2.5	0906599990	GP-OR-20x2,5-NBR90
S 16		1/2	18.64 x 3.53	0906749990	GP-OR-18,64x3,53-NBR90
S 16		3/4	24.99 x 3.53	0906719990	GP-OR-24,99x3,53-NBR90
S 20		3/4	24.99 x 3.53	0906719990	GP-OR-24,99x3,53-NBR90
S 20	35		20 x 2.5	0906599990	GP-OR-20x2,5-NBR90
S 20	40		26 x 2.5	0900189990	GP-OR-26x2,5-NBR90
S 20	55		32 x 2.5	0900929990	GP-OR-32x2,5-NBR90
S 25		1 1/4	37.69 x 3.53	0906739990	GP-OR-37,69x3,53-NBR90
S 25	55		32 x 2.5	0900929990	GP-OR-32x2,5-NBR90
S 25		3/4	24.99 x 3.53	0906719990	GP-OR-24,99x3,53-NBR90
S 30	55		32 x 2.5	0900929990	GP-OR-32x2,5-NBR90
S 30		1	32.92 x 3.53	0906729990	GP-OR-32,92x3,53-NBR90
S 30		1 1/4	37.69 x 3.53	0906739990	GP-OR-37,69x3,53-NBR90
S 38		1 1/2	47.22 x 3.53	0906549990	GP-OR-47,22x3,53-NBR90
S 38		1 1/4	37.69 x 3.53	0906739990	GP-OR-37,69x3,53-NBR90



Sealing rings for VOSSForm^{SQR} tube couplings

Standard moulded seal material is FPM/FKM

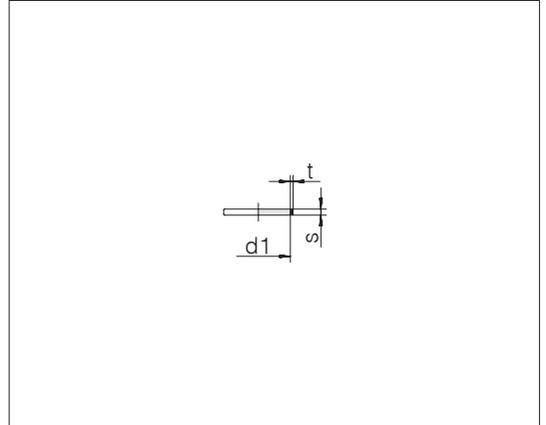

Series Tube OD	d1 x s	t	Order-No.	Designation
L/S 6	6 x 1.8	0.7	0912309790	24-SQRMS-L/S6-FKM90
L/S 8	8 x 1.8	0.7	0912319790	24-SQRMS-L/S8-FKM90
L/S 10	10 x 2	0.7	0912329790	24-SQRMS-L/S10-FKM90
L/S 12	12 x 2	0.7	0912339790	24-SQRMS-L/S12-FKM90
L 15	15 x 2	0.7	0912349790	24-SQRMS-L15-FKM90
L 18	18 x 2	0.7	0912359790	24-SQRMS-L18-FKM90
L 22	22 x 2	0.7	0912369790	24-SQRMS-L22-FKM90
L 28	28 x 2	0.7	0912379790	24-SQRMS-L28-FKM90
L 35	35 x 2.6	0.9	0912389790	24-SQRMS-L35-FKM90
L 42	42 x 2.6	0.9	0912399790	24-SQRMS-L42-FKM90
S 14	14 x 2	0.7	0912409790	24-SQRMS-S14-FKM90
S 16	16 x 2	0.7	0912419790	24-SQRMS-S16-FKM90
S 20	20 x 2.5	0.9	0912429790	24-SQRMS-S20-FKM90
S 25	25 x 2.5	0.9	0912439790	24-SQRMS-S25-FKM90
S 30	30 x 2.6	0.9	0912449790	24-SQRMS-S30-FKM90
S 38	38 x 2.6	0.9	0912459790	24-SQRMS-S38-FKM90

Sealing rings for VOSSForm^{SQR} tube couplings

Alternative moulded seal material is EPDM

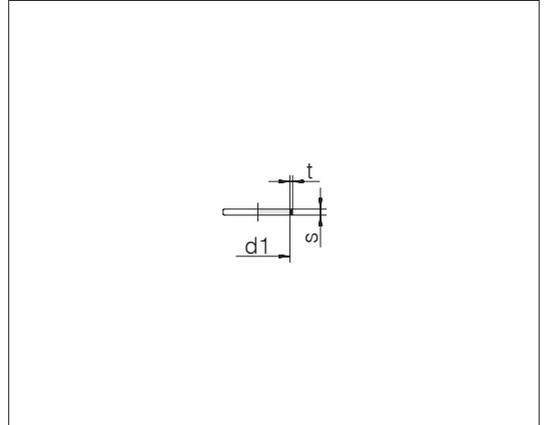

Series Tube OD	d1 x s	t	Order-No.	Designation
L/S 6	6 x 1.8	0.7	0912309676	24-SQRMS-L/S6-EPDM85
L/S 8	8 x 1.8	0.7	0912319676	24-SQRMS-L/S8-EPDM85
L/S 10	10 x 2	0.7	0912329676	24-SQRMS-L/S10-EPDM85
L/S 12	12 x 2	0.7	0912339676	24-SQRMS-L/S12-EPDM85
L 15	15 x 2	0.7	0912349676	24-SQRMS-L15-EPDM85
L 18	18 x 2	0.7	0912359676	24-SQRMS-L18-EPDM85
L 22	22 x 2	0.7	0912369676	24-SQRMS-L22-EPDM85
L 28	28 x 2	0.7	0912379676	24-SQRMS-L28-EPDM85
L 35	35 x 2.6	0.9	0912389676	24-SQRMS-L35-EPDM85
L 42	42 x 2.6	0.9	0912399676	24-SQRMS-L42-EPDM85
S 14	14 x 2	0.7	0912409676	24-SQRMS-S14-EPDM85
S 16	16 x 2	0.7	0912419676	24-SQRMS-S16-EPDM85
S 20	20 x 2.5	0.9	0912429676	24-SQRMS-S20-EPDM85
S 25	25 x 2.5	0.9	0912439676	24-SQRMS-S25-EPDM85
S 30	30 x 2.6	0.9	0912449676	24-SQRMS-S30-EPDM85
S 38	38 x 2.6	0.9	0912459676	24-SQRMS-S38-EPDM85

Sealing rings for 24/37° flare adapters

- O-ring (O) for the 24° taper
- O-ring (P) for the 37° taper

Alternative O-ring material is FPM/FKM

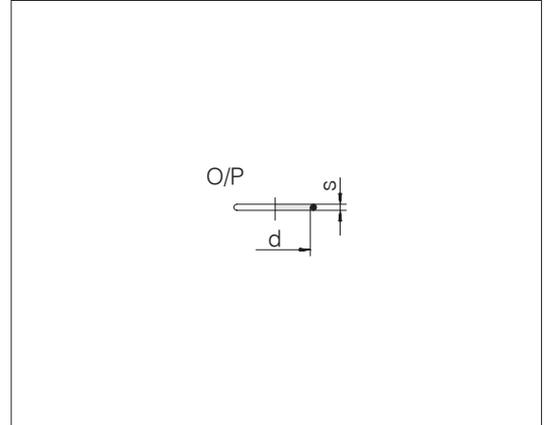

Series	Tube OD	d x s	Order-No.	Designation	O	d x s	Order-No.	Designation	P
L	6	4 x 1.5	0900009700	GP-OR-4x1,5-FKM80		4.4 x 0.8	0901559700	GP-OR-4,4x0,8-FKM80	
L	8	6 x 1.5	0900029700	GP-OR-6x1,5-FKM80		6 x 0.8	0901569700	GP-OR-6x0,8-FKM80	
L	10	7.5 x 1.5	0900419700	GP-OR-7,5x1,5-FKM80		7.5 x 0.8	0901579700	GP-OR-7,5x0,8-FKM80	
L	12	9 x 1.5	0900429700	GP-OR-9x1,5-FKM80		9.5 x 0.8	0901589700	GP-OR-9,5x0,8-FKM80	
L	15	12 x 2	0900449700	GP-OR-12x2-FKM80		12.5 x 0.8	0901599700	GP-OR-12,5x0,8-FKM80	
L	18	15 x 2	0900389700	GP-OR-15x2-FKM80		15 x 1	0908889700	GP-OR-15x1-FKM80	
L	22	20 x 2	0906199700	GP-OR-20x2-FKM80		18 x 1	0908989700	GP-OR-18x1-FKM80	
L	28	26 x 2	0906589700	GP-OR-26x2-FKM80		23 x 1	0901629700	GP-OR-23x1-FKM80	
L	35	32 x 2.5	0900929700	GP-OR-32x2,5-FKM80		30 x 1	0908969700	GP-OR-30x1-FKM80	
L	42	38 x 2.5	0900949700	GP-OR-38x2,5-FKM80		37 x 1	0901639700	GP-OR-37x1-FKM80	
S	6	4 x 1.5	0900009700	GP-OR-4x1,5-FKM80		4.4 x 0.8	0901559700	GP-OR-4,4x0,8-FKM80	
S	8	6 x 1.5	0900029700	GP-OR-6x1,5-FKM80		6 x 0.8	0901569700	GP-OR-6x0,8-FKM80	
S	10	7.5 x 1.5	0900419700	GP-OR-7,5x1,5-FKM80		7.5 x 0.8	0901579700	GP-OR-7,5x0,8-FKM80	
S	12	9 x 1.5	0900429700	GP-OR-9x1,5-FKM80		9.5 x 0.8	0901589700	GP-OR-9,5x0,8-FKM80	
S	14	10 x 2	0900439700	GP-OR-10x2-FKM80		11 x 1	0901609700	GP-OR-11x1-FKM80	
S	16	12 x 2	0900449700	GP-OR-12x2-FKM80		12.5 x 1	0901619700	GP-OR-12,5x1-FKM80	
S	20	16.3 x 2.4	0900459700	GP-OR-16,3x2,4-FKM70		16 x 1	0908939700	GP-OR-16x1-FKM80	
S	25	20.3 x 2.4	0900469700	GP-OR-20,3x2,4-FKM80		20 x 1	0908949700	GP-OR-20x1-FKM80	
S	30	25.3 x 2.4	0900479700	GP-OR-25,3x2,4-FKM80		25 x 1	0908959700	GP-OR-25x1-FKM80	
S	38	33.3 x 2.4	0900489700	GP-OR-33,3x2,4-FKM80		32 x 1.78	0901649700	GP-OR-32x1,78-FKM80	

Flange couplings / ZAKO / ZAKO LP

- Flange couplings with cutting ring connection
- ZAKO flared flanges
- ZAKO LP flared flanges

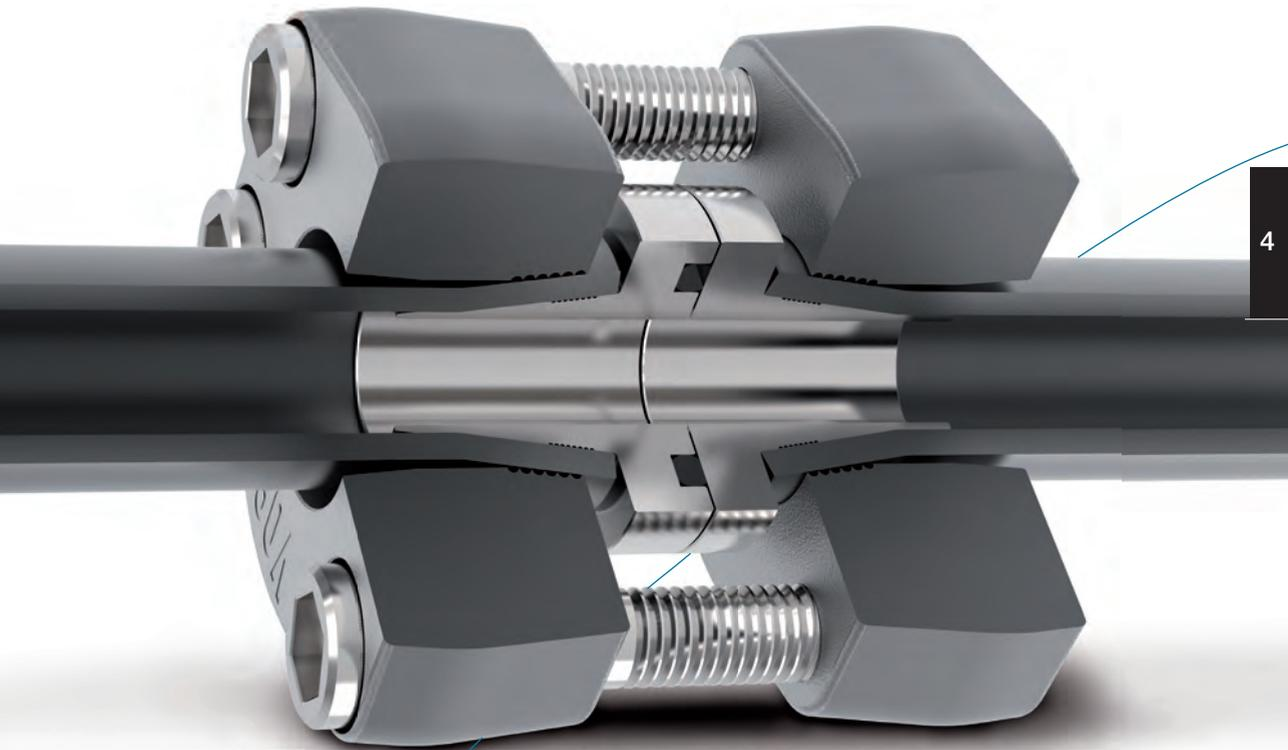

Content	Type/Page	
The new product designations of VOSS products	P.238	
Product information, flange couplings	P.244	
Product information, ZAKO flange couplings	P.245	
Flange couplings with cutting ring and square flange connection	FSO  P.250	FEO  P.251
Flange couplings with cutting ring connection and divided SAE flange	FSO  P.254	FEO  P.256
Flange couplings with cutting ring and square flange connection, Individual parts	FS  P.260	FE  P.261
Flange couplings with cutting ring connection and split SAE flange, individual parts	FCS, FSX, FEX  P.264	

Content	Type/Page				
ZAKO flared flanges with SAE flange connection	TPO (standard)	TPO (high pressure)	TTO (standard)	TTO (high pressure)	
	 P.268	 P.270	 P.272	 P.273	
ZAKO flared flanges with square flange connection	TPO	TTO			
	 P.276	 P.278			
ZAKO, individual parts	RGO	R	FPH	FPT	FPH
	 P.282	 P.284	 P.286	 P.287	 P.288
ZAKO LP flared flange with SAE flange connection	TPO	TTO	TTEO		
	 P.290	 P.291	 P.293		
ZAKO LP flared flange, individual parts	RGO	R	FPH		
	 P.295	 P.296	 P.297		

The new designations of VOSS products



This catalog contains a new, alphanumerical product designation system based to a large extent on ISO 8434-1. This makes the designation self-explanatory and facilitates identification of the products. Since the structure is based on English, the designation is understood internationally.

Furthermore, the new product designations make it possible to generate customized special solutions by combining variations of the existing VOSS product program.

Example: Z-TPO-30x4-HC62-M12-C19

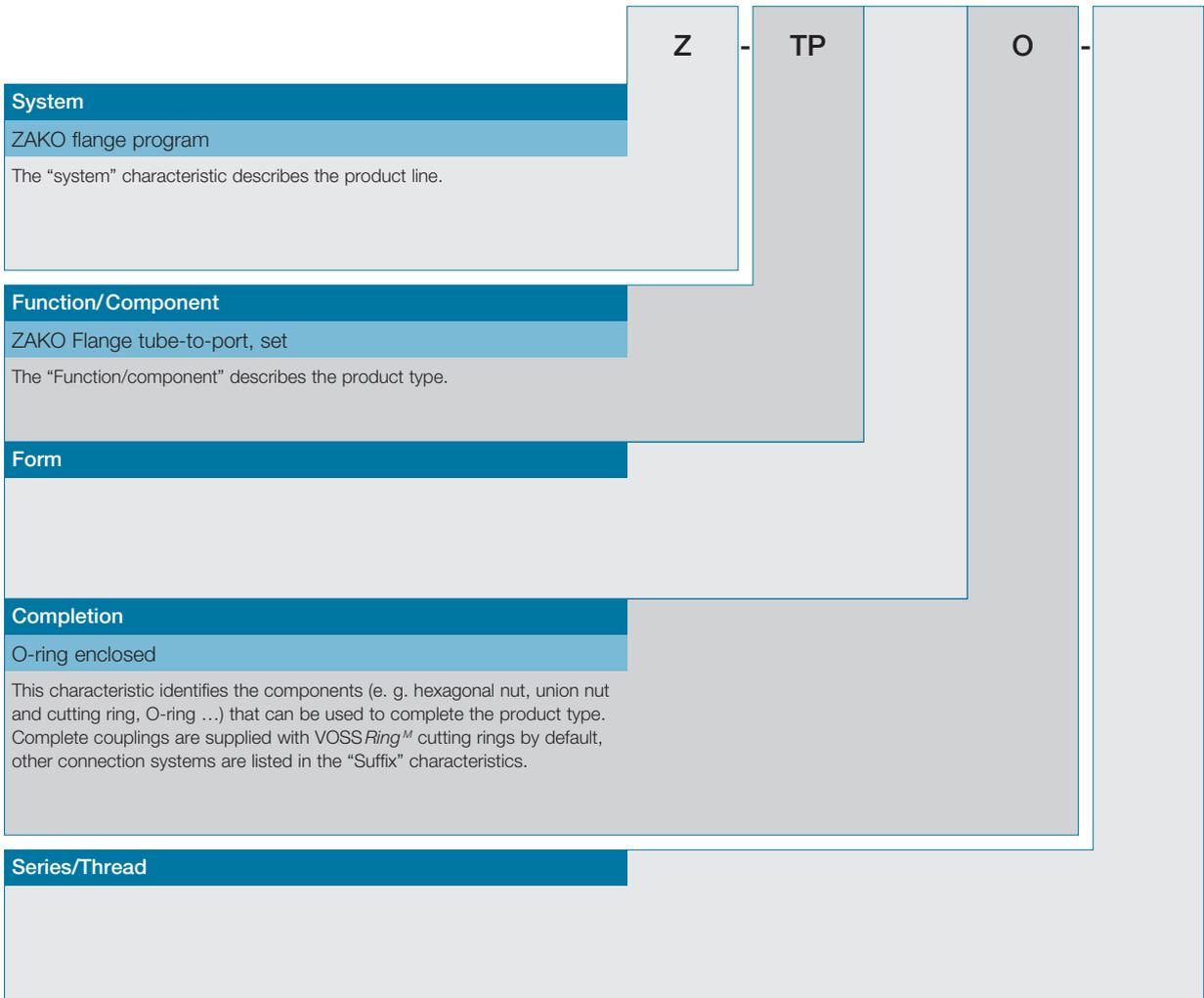

ZAKO connecting flange coupling set, square flange for 30x4 mm tube, hole circle 62 mm, screw size M12, blackened, oiled or burnished steel



Examples of how to order items, as well as additional explanations and variation options are given in the respective chapters and in the following pages for the individual product groups.

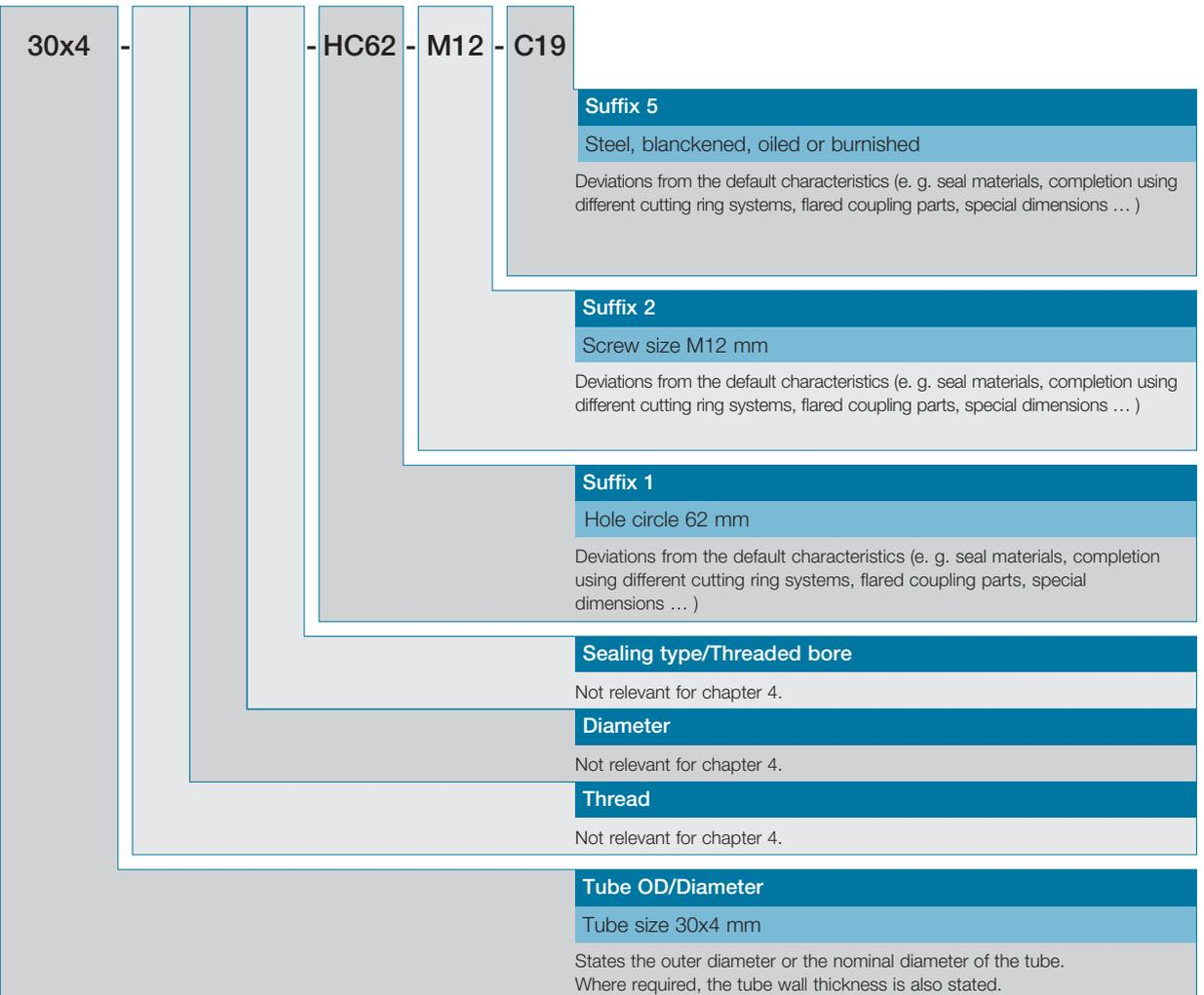



System

24	24° DIN program
GP	General program (components and accessories, applicable in different connecting systems)
Z	ZAKO flange program

Function

Flanges

F	Flanges
FCS	Split flange clamps

ZAKO Flanges

FPH	ZAKO Flange plates with hole
FPT	ZAKO Flange plates with thread
PT	ZAKO Flanges port-to-tube, set
TP	ZAKO Flanges tube-to-port, set
TT	ZAKO Flanges tube-to-tube, set
RG	ZAKO Rings with groove
R	ZAKO Rings without groove

Form

E	Elbow
S	Straight
T	Tee

Completion

C	Complete connection (with tube connecting system)
O	O-ring enclosed
X	Tube socket not pre-assembled / only body

Series/Thread

Series

L	Light series
S	Heavy series

Others

LP	ZAKO low pressure
----	-------------------





	Tube OD/Diameter
10	10 mm
12	12 mm
15	15 mm
16	16 mm
18	18 mm
20	20 mm
22	22 mm
25	25 mm
28	28 mm
30	30 mm
35	35 mm
38	38 mm
42	42 mm
43.3	43.3 mm
48.3	48.3 mm
50	50 mm
60.3	60.3 mm
65	65 mm
76.1	76.1 mm
80	80 mm
88.9	88.9 mm
101.6	101.6 mm
114.3	114.3 mm

	Suffix overview
Suffix 1	Flange hole pattern
Suffix 2	Flange screw diameter
Suffix 5	Completion
Suffix 6	Differing dimension
Suffix 7	Material/Strength
Suffix 8	Coating

Suffixes not referred to here are not relevant to this chapter.

Note: For articles having more than one relevant suffix, these are listed in numerical order in the sales designation.

Suffix 1	Flange hole pattern
	SAE pattern
3S1/2	3000 psi SAE 1/2 "
3S3/4	3000 psi SAE 3/4 "
3S1	3000 psi SAE 1 "
3S11/4	3000 psi SAE 1 1/4 "
3S11/2	3000 psi SAE 1 1/2 "
3S2	3000 psi SAE 2 "
3S21/2	3000 psi SAE 2 1/2 "
3S3	3000 psi SAE 3 "
3S31/2	3000 psi SAE 3 1/2 "



3S4	3000 psi SAE 4 "
6S1/2	6000 psi SAE 1/2 "
6S3/4	6000 psi SAE 3/4 "
6S1	6000 psi SAE 1 "
6S11/4	6000 psi SAE 1 1/4 "
6S11/2	6000 psi SAE 1 1/2 "
6S2	6000 psi SAE 2 "

Hole circle

HC35	Hole circle 35 mm
HC40	Hole circle 40 mm
HC42	Hole circle 42 mm
HC45	Hole circle 45 mm
HC50	Hole circle 50 mm
HC55	Hole circle 55 mm
HC62	Hole circle 62 mm
HC72	Hole circle 72 mm
HC85	Hole circle 85 mm
HC98	Hole circle 98 mm
HC118	Hole circle 118 mm
HC145	Hole circle 145 mm
HC175	Hole circle 175 mm

Suffix 2 Flange screw diameter

Flange screw hole diameter

D10,75	Diameter 10.75 mm
...	...

Flange screw size

M10	Metric 10 mm
IM16	Internal thread, metric 16 mm
...	...

Suffix 5 Completion

1S	1S Cutting ring
ES4	ES-4 Cutting ring
BV10	BV-10 Set
24/37	24/37° Set

Suffix 6 Differing dimension

Dimension

HD75	Hub diameter 75 mm
...	...

Suffix 7 Material/Strength

Screw strength

8.8	8.8
10.9	10.9





Suffix 8	Coating
C19	Steel, blackened, oiled or burnished
C24	Steel zinc plated, blue chromated

Product information, flange couplings

In addition to screwed tube couplings for the various installation criteria, flanges are also frequently used in hydraulic systems, preferably for medium-range and large coupling dimensions. Various flange versions are provided in order to meet different requirements.

Flange couplings with square flanges and cutting ring connection



These flange couplings with a square flange connection are characterized by very compact external dimensions. Both straight and elbow versions are available. The product range covers tube outer diameters ranging from 10 mm to 35 mm. The flange connections are sealed with a circular elastic sealing ring (O-ring), and the physical connection is made using cheese-head screws. The flange connections are designed to match the connection hole patterns of leading pump manufacturers.

SAE flange couplings with cutting ring connection



SAE flange couplings are supplied both as standard and as high-pressure designs with hole patterns in accordance with SAE J 518 or ISO 6162.

The device-side connection is made with 2 flange halves secured with 4 cheese head screws. In contrast to normal threaded studs, the screws can be fastened in the couplings using smaller tools and lower forces. The tube connections can be made using cutting rings or BV-10 flared couplings, for instance.

One special advantage of the SAE flange elbow couplings is that the connection direction is adjustable. Nevertheless, accessibility of the mounting screws must be ensured when installing the tubes.

The VOSS ZAKO system with the 10° flare connection is provided for especially high stresses, such as are caused by vibration and pressure jolts or high pressures in tubes with larger diameters.

General note

In order for the flange couplings listed in this catalogue to fulfil their function, the installation instructions and the note in the technical remarks must be followed exactly.

Product information, ZAKO flange couplings



In hydraulic engineering, the ZAKO range of flanges is a synonym for reliability on a large scale, as this unique design not only stands up to the hardest stresses without any problems, it is also conceived for use with large-diameter tubes. With the 10° flare system and the exclusive VOSS coat finish providing optimum corrosion protection, ZAKO flanges set the absolute standard in all fields of hydraulics, proving their worth e. g. in strip-mining equipment, hydraulic presses and injection-moulding machinery.

ZAKO – creates confidence right from the start

For tubes with outer diameters ranging from 16 mm to 114.3 mm and wall thicknesses up to 17.5 mm.

- Standard series for up to 250 bar and high-pressure series for up to 400 bar, with four-fold safety.
- For standard hole patterns in accordance with SAE (3000 psi/6000 psi) and square flanges.
- Maximum possible corrosion resistance thanks to VOSS coat finish, also available with phosphate surface finish as an option.
- Superior 10° flare system
- Also available: ZAKO LP – the low-pressure version for up to 60 bar and applications in the low-pressure range (e. g. for fluid return lines and lubrication lines)

This removable flange system eliminates complicated welding work

Compared to conventional welded joints, the ZAKO system is also convincing from the economical and technical aspects.

- Removable connections are ideal for servicing and maintenance
- Permissible operating pressures with four-fold safety
- Fast assembly, saving time and money
- Lower component process costs
- Can be installed in high fire hazard environments
- No complex process steps (tack-welds, setting up, seal-welding, cleaning, flame-tempering and straightening)

The perfect design for efficient installation

ZAKO system tube couplings consist of four perfectly matching elements: a ZAKO ring, an O-ring, a flange, and the connecting screws or bolts. The tried and tested 10° flare principle in conjunction with the ZAKO ring ensures a notch-effect-free and incision-free preliminary assembly. To achieve this, the ZAKO ring is pressed accurately into the tube at a very high pressure applied by special pre-assembly equipment. This, in conjunction with an additional labyrinth seal, ensures that the system is strong and leak-tight.

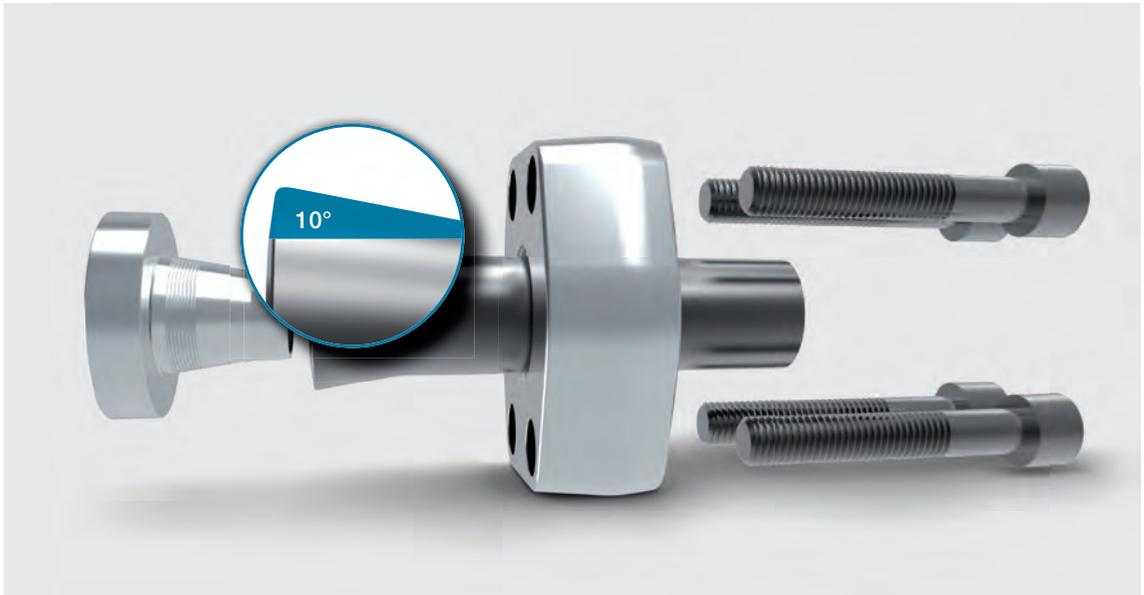
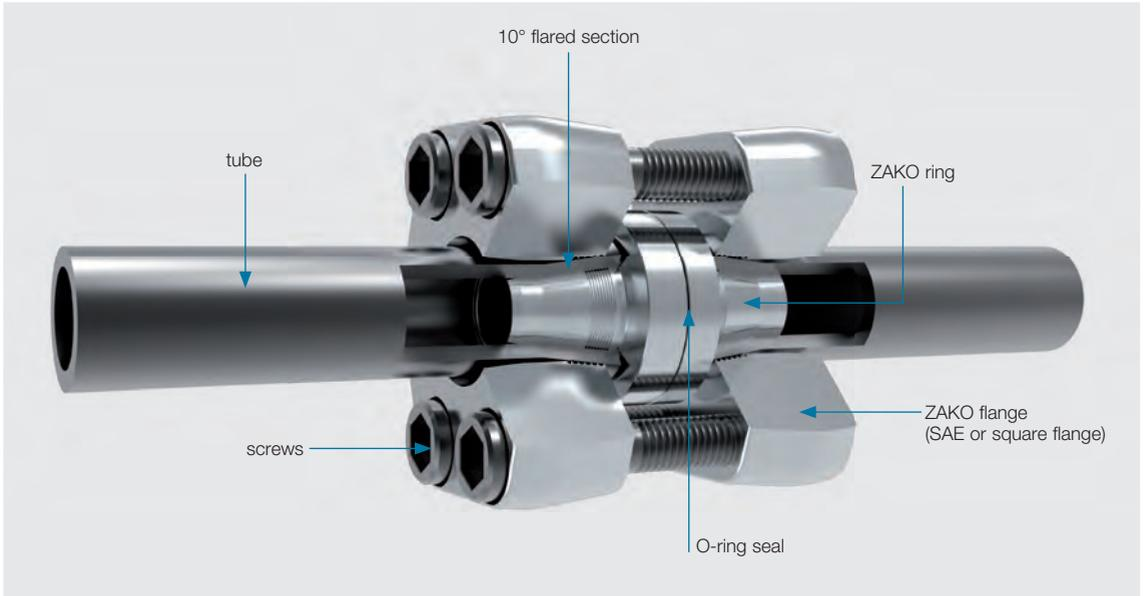

As opposed to systems with conventional flare angles of 37°, ZAKO flange systems have a 10° taper angle and small "saw teeth" on the flared section. Many years of experience using this system combined with extensive force measurement tests have shown the considerable

advantages of the system in terms of stability and safety. As the tube is only flared by 10°, the material is not expanded too far and thus retains sufficient elasticity to withstand strong alternating bending stresses.

10° means ...

■ greater function reserves

The low expansion of the tube end achieves unimpaired material strength.

■ higher compression force

The compression force achieved using the equivalent bolt tension is approximately 3.5 times greater than with comparable 37° systems.

■ optimized assembly without tool wear

The ZAKO ring is a tool and component in one and is press-fitted into the tube during the pre-assembly process.

■ easy utilization

No special assembly limit couplings (stops) required.

■ better support

A long flared section supports the coupling system better and greatly increases its stability under dynamic loads.

■ better sealing

The saw-tooth surface of the flared section achieves an additional labyrinth-seal effect.

ZAKO flange systems are available for tubes with outer diameters of 16 – 114.3 mm and various wall thicknesses. All sizes are available as standard, high-pressure versions (for up to 400 bar) and low-pressure versions (for up to 60 bar).

Overview of the 10° flange system

ZAKO

tube OD* [mm]	wall thickness [mm]
16	2 2.5 3
20	2.5 3 3.5
25	3 4
30	4 5
38	4 5 6
42	2
50	2.5 5 6 8 9
60	3 5 10
65	3 4 5 8
75	12.5
80	3 8 10
88	14
101.6	16
114.3	17.5

* outer diameter

ZAKO LP

tube OD* [mm]	wall thickness [mm]
48.3	3.2 4
60.3	3.6 4.5
76.1	3.6 5
88.9	3.6 5
114.3	3.6 6.3

The ZAKO principle

ZAKO flange couplings are easily and safely assembled. A pre-assembly device is used to press the ZAKO ring into the tube which is to be connected by the system. In this process, the ZAKO collar ring serves both as a flaring tool and a component that remains in the flared tube. This means that possible process faults due to worn tools are eliminated. After this, the two tubes are joined together using the flanges and connecting bolts or screws. An O-ring integrated into the ZAKO collar ring is used to seal the coupling. The 10° flare angle of this system provides a very long contact area that supports the connection, ensuring that the connection's stability is maintained even under high dynamic loads. Flange connections are easily taken apart to permit service and maintenance work.

Pre-assembly devices

Depending on where and how you intend to pre-assemble the ZAKO rings, we offer you a wide range of pre-assembly devices, ranging from manually operated tools for occasional use right up to high-performance equipment for mass production.

Type 80 N3

Tube OD 16 – 38 mm



Type 90 Basic II

Tube OD 16 – 38 mm



Type 90 Comfort

Tube OD 16 – 38 mm



Type 85

Tube OD 38 – 114.3 mm

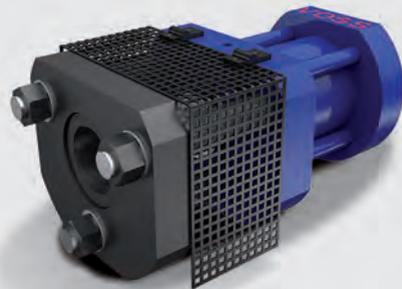

Flange couplings with cutting ring and square flange connection

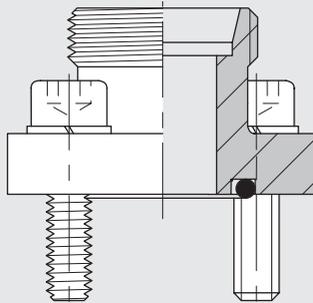

Straight flange couplings

With cutting ring and square flange connection

Standard O-ring material is NBR

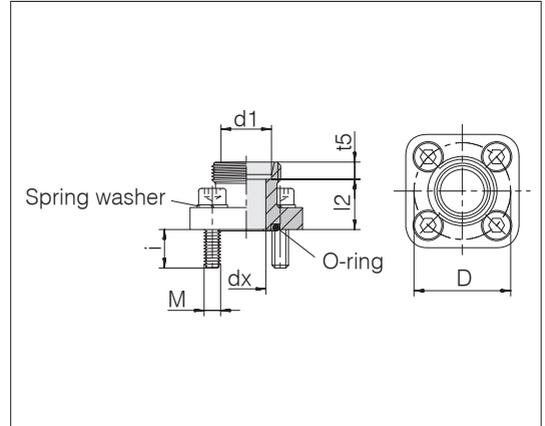

Series	Tube OD	PB	Hole circle Ø D	dx	l2	t5	i ca.	4 x cyl. screws	O-ring	Nm	kg/100 ca.	Order-No.	Designation
L	10	315	35	8	23	7	12.5	M 6 x 22	20 x 2,5	10	13.4	0195362081	24-FSO-L10-HC35-M6
L	12	315	35	10	23	7	12.5	M 6 x 22	20 x 2,5	10	12.7	0195372081	24-FSO-L12-HC35-M6
L	15	100	40	12	27.5	7	12.5	M 6 x 22	26 x 2,5	10	15.8	0195392081	24-FSO-L15-HC40-M6
L	15	250	35	12	23	7	12.5	M 6 x 22	20 x 2,5	10	13.1	0195382081	24-FSO-L15-HC35-M6
L	18	100	35	12	22.5	7.5	12.5	M 6 x 22	26 x 2,5	10	14.8	0196102081	24-FSO-L18-HC35-M6
L	18	100	40	19	27.5	7.5	12.5	M 6 x 22	26 x 2,5	10	16.3	0195402081	24-FSO-L18-HC40-M6
L	22	100	40	19	27.5	7.5	12.5	M 6 x 22	26 x 2,5	10	15.6	0195412081	24-FSO-L22-HC40-M6
L	28	100	40	20	34.5	7.5	12.5	M 6 x 22	26 x 2,5	10	19.4	0195142081	24-FSO-L28-HC40-M6
L	28	100	55	20	32.5	7.5	11.5	M 8 x 25	32 x 2,5	25	38.4	0195902081	24-FSO-L28-HC55-M8
L	35	100	55	28	39.5	10.5	11.5	M 8 x 25	32 x 2,5	25	40.9	0195872081	24-FSO-L35-HC55-M8
S	16	315	35	12	21.5	8.5	12.5	M 6 x 22	20 x 2,5	10	12.8	0195102081	24-FSO-S16-HC35-M6
S	20	315	55	16	29.5	10.5	11.5	M 8 x 25	33 x 2,5	25	37.1	0195232081	24-FSO-S20-HC55-M8

Nm = recommended tightening torques (Nm max.) for cylindrical bolts as spec. in DIN 912 (8.8) for friction coefficient μ tot. 0.14.

Example for comp. :
BFG10L/LK350MDCF



Elbow flange couplings

With cutting ring and square flange connection

Standard O-ring material is NBR

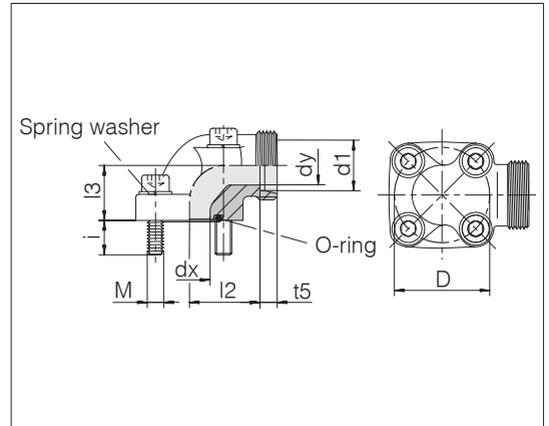

Series	Tube OD	PB	Hole circle Ø D	dx	dy	l2	l3	t5	i ca.	4 x cyl. screws	O-ring	Nm	kg/100 ca.	Order-No.	Designation
L	10	315	35	14	8	31	16.5	7	12.5	2 x M 6 x 22 2 x M 6 x 35	20 x 2,5	10	18.6	0195422081	24-FEO-L10-HC35-M6
L	12	315	35	14	10	31	16.5	7	12.5	2 x M 6 x 22 2 x M 6 x 35	20 x 2,5	10	16.8	0195622081	24-FEO-L12-HC35-M6
L	15	100	40	20	12	31	22.5	7	12.5	4 x M 6 x 22	26 x 2,5	10	20.4	0195642081	24-FEO-L15-HC40-M6
L	15	250	35	14	12	31	16.5	7	12.5	2 x M 6 x 22 2 x M 6 x 35	20 x 2,5	10	17.8	0195632081	24-FEO-L15-HC35-M6
L	18	100	40	20	15	30.5	22.5	7.5	12.5	4 x M 6 x 22	26 x 2,5	10	20.6	0195432081	24-FEO-L18-HC40-M6
L	18	250	35	15	15	30.5	20	7.5	12.5	2 x M 6 x 22 2 x M 6 x 40	20 x 2,5	10	22.8	0195452081	24-FEO-L18-HC35-M6
L	22	100	40	20	19	30.5	22.5	7.5	12.5	4 x M 6 x 22	26 x 2,5	10	20.9	0195442081	24-FEO-L22-HC40-M6
L	28	100	40	20	25	32.5	28	7.5	12.5	2 x M 6 x 22 2 x M 6 x 50	26 x 2,5	10	29.9	0195152081	24-FEO-L28-HC40-M6
L	35	100	40	20	31	30.5	34	10.5	12.5	2 x M 6 x 22 2 x M 6 x 60	26 x 2,5	10	39.5	0195272081	24-FEO-L35-HC40-M6
L	35	100	55	26	31	38.5	32	10.5	11.5	2 x M 8 x 25 2 x M 8 x 60	32 x 2,5	25	57.9	0195172081	24-FEO-L35-HC55-M8
L	42	100	55	26	38	38	40	8.5	11	2 x M 8 x 25 2 x M 8 x 70	32 x 2,5	25	61.0	0195192081	24-FEO-L42-HC55-M8
S	16	315	35	15	12.5	29.5	20	8.5	12.5	2 x M 6 x 22 2 x M 6 x 40	20 x 2,5	10	22.1	0195252081	24-FEO-S16-HC35-M6
S	20	250	40	20	16	29.5	22	10.5	12.5	2 x M 6 x 22 2 x M 6 x 45	26 x 2,5	10	25.5	0195132081	24-FEO-S20-HC40-M6
S	20	250	55	20	16	34.5	24	10.5	11	2 x M 8 x 25 2 x M 8 x 50	32 x 2,5	25	52.9	0195182081	24-FEO-S20-HC55-M8
S	20	315	35	15	16	34.5	25	10.5	11	2 x M 6 x 22 2 x M 6 x 45	20 x 2,5	10	29.1	0195112081	24-FEO-S20-HC35-M6
S	25	250	55	20	20	37	30	12	11.5	2 x M 8 x 25 2 x M 8 x 55	32 x 2,5	25	61.3	0195892081	24-FEO-S25-HC55-M8
S	30	250	55	26	26	35.5	32	13.5	11	2 x M 8 x 25 2 x M 8 x 50	32 x 2,5	25	58.4	0195242081	24-FEO-S30-HC55-M8

Nm = recommended tightening torques (Nm max.) for cylindrical bolts as spec. in DIN 912 (8.8) for friction coefficient μ tot. 0.14.

Example for comp. :
BFW10L/LK350MDCF

Flange couplings with cutting ring connection and divided SAE flange

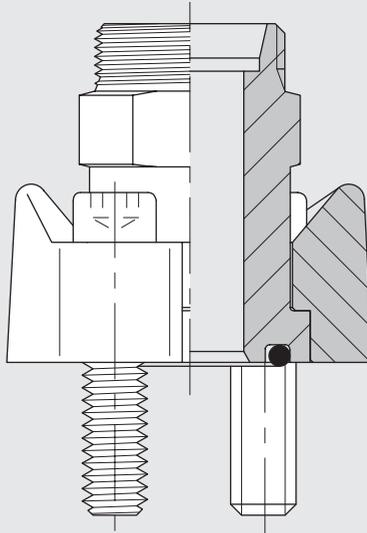

Straight flange couplings

With cutting ring connection and split SAE flange
 Hole pattern according to SAE J 518 C / ISO 6162
 Standard series (3000 psi)

Standard O-ring material is NBR

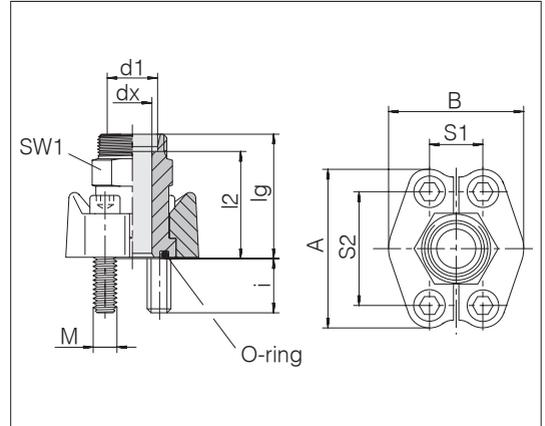

Series	Fl. size	PB	dx	lg	SW1	l2	S1	S2	A	B	i	4 x cyl. screws	O-ring	Nm	Order-No.	Designation	
L	18	3/4"	315	15	53	30	45.5	22.2	47.6	65	52	16	M 10 x 30	25 x 3,53	50	0305002081	24-FSO-L18-3S3/4-M10
L	22	3/4"	160	19	53	30	45.5	22.2	47.6	65	52	16	M 10 x 30	25 x 3,53	50	0305012081	24-FSO-L22-3S3/4-M10
L	28	1"	160	24	54	36	46.5	26.2	52.4	70	59	14	M 10 x 30	32,92 x 3,53	50	0305022081	24-FSO-L28-3S1-M10
L	35	1 1/4"	160	30	58	41	47.5	30.2	58.7	79	73	24	M 12 x 35	37,7 x 3,53	85	0305032081	24-FSO-L35-3S11/4-M12
L	42	1 1/2"	160	36	64	46	53	35.7	69.9	94	83	14	M 12 x 35	47,22 x 3,53	85	0305042081	24-FSO-L42-3S11/2-M12
S	20	3/4"	350	16	57	30	46.5	22.2	47.6	65	52	16	M 10 x 30	25 x 3,53	50	0305052081	24-FSO-S20-3S3/4-M10
S	25	3/4"	350	17	57	30	45	22.2	47.6	65	52	16	M 10 x 30	25 x 3,53	50	0305062081	24-FSO-S25-3S3/4-M10
S	25	1 1/4"	280	20	60	41	48	30.2	58.7	79	73	24	M 12 x 35	37,7 x 3,53	85	0305072081	24-FSO-S25-3S11/4-M12
S	30	1"	350	24	63	36	49.5	26.2	52.4	70	59	14	M 10 x 30	32,92 x 3,53	50	0305082081	24-FSO-S30-3S1-M10
S	30	1 1/4"	280	25	62	41	48.5	30.2	58.7	79	73	24	M 12 x 35	37,7 x 3,53	85	0305092081	24-FSO-S30-3S11/4-M12
S	38	1 1/4"	280	28	66	46	50.5	30.2	58.7	79	73	24	M 12 x 35	37,7 x 3,53	85	0305102081	24-FSO-S38-3S11/4-M12
S	38	1 1/2"	210	32	70	46	54	35.7	69.9	94	83	19	M 12 x 35	47,22 x 3,53	85	0305112081	24-FSO-S38-3S11/2-M12

Nm = recommended tightening torques (Nm max.) for cylindrical bolts as spec. in ISO 4762 (10.9) for friction coefficient μ tot. 0.14.

Example for comp. :
 GFS33/18LOMDCF



Straight flange couplings

With cutting ring connection and devided SAE flange
 Hole pattern according to SAE J 518 C / ISO 6162
 High-pressure series (6000 psi)

Standard O-ring material is NBR

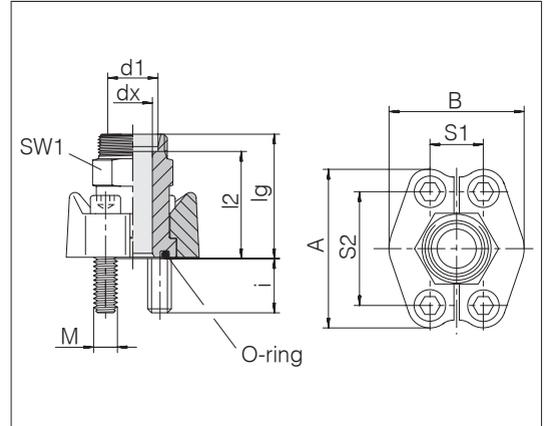

Series	Tube OD	d1	Fl. size	PB	dx	lg	SW1	l2	S1	S2	A	B	i	4 x cyl. screws	O-ring	Nm	Order-No.	Designation
S	16	3/4"	400	12	59	30	50.5	23.8	50.8	71	60	16	16	M 10 x 35	25 x 3,53	50	0305242081	24-FSO-S16-6S3/4-M10
S	20	3/4"	400	16	61	30	50.5	23.8	50.8	71	60	16	16	M 10 x 35	25 x 3,53	50	0305252081	24-FSO-S20-6S3/4-M10
S	25	3/4"	400	17	63	30	51	23.8	50.8	71	60	16	16	M 10 x 35	25 x 3,53	50	0305262081	24-FSO-S25-6S3/4-M10
S	25	1"	400	20	72	36	60	27.8	57.2	81	70	21	21	M 12 x 45	32,92 x 3,53	85	0305272081	24-FSO-S25-6S1-M12
S	30	1"	400	24	74	36	60.5	27.8	57.2	81	70	21	21	M 12 x 45	32,92 x 3,53	85	0305282081	24-FSO-S30-6S1-M12
S	30	1 1/4"	400	25	79	41	65.5	31.8	66.7	95	78	23	23	M 14 x 50	37,7 x 3,53	135	0305302081	24-FSO-S30-6S11/4-M14
S	38	1 1/4"	315	30	83	46	67	31.8	66.7	95	78	23	23	M 14 x 50	37,7 x 3,53	135	0305322081	24-FSO-S38-6S11/4-M14
S	38	1 1/2"	315	30	89	46	73	36.5	79.4	113	95	25	25	M 16 x 55	47,22 x 3,53	210	0305342081	24-FSO-S38-6S11/2-M16

Nm = recommended tightening torques (Nm max.) for cylindrical bolts as spec. in ISO 4762 (10.9) for friction coefficient μ tot. 0.14.

Example for comp. :
 GFS63/16SOMDCF

Elbow flange couplings

With cutting ring connection and devided SAE flange
 Hole pattern according to SAE J 518 C / ISO 6162
 Standard series (3000 psi)

Standard O-ring material is NBR

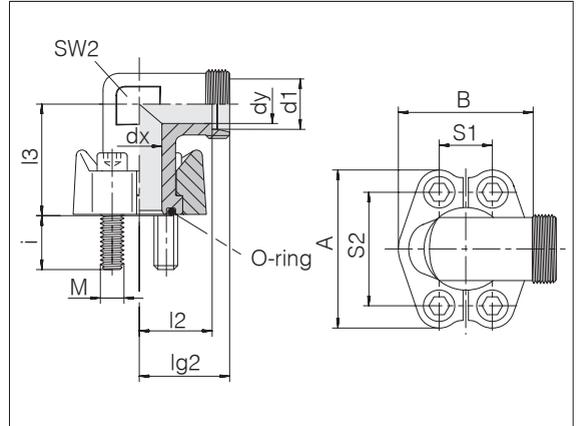

Series	Fl. size	PB	dx	dy	lg2	SW2	l2	l3	S1	S2	A	B	i	4 x cyl. screws	O-ring	Nm	Order-No.	Designation	
L	18	3/4"	315	19	15	39	30	31.5	42	22.2	47.6	65	52	16	M 10 x 30	25 x 3,53	50	0305122081	24-FEO-L18-3S3/4-M10
L	22	3/4"	160	19	19	41	30	33.5	42	22.2	47.6	65	52	16	M 10 x 30	25 x 3,53	50	0305132081	24-FEO-L22-3S3/4-M10
L	28	1"	160	25	24	44	36	36.5	45	26.2	52.4	70	59	14	M 10 x 30	32,92 x 3,53	50	0305142081	24-FEO-L28-3S1-M10
L	35	1 1/4"	160	27	30	57	41	46.5	50	30.2	58.7	79	73	24	M 12 x 35	37,7 x 3,53	85	0305152081	24-FEO-L35-3S11/4-M12
L	42	1 1/2"	160	36	36	58	50	47	55	35.7	69.9	94	83	19	M 12 x 35	47,22 x 3,53	85	0305162081	24-FEO-L42-3S11/2-M12
S	20	3/4"	350	19	16	43	30	32.5	42	22.2	47.6	65	52	16	M 10 x 30	25 x 3,53	50	0305172081	24-FEO-S20-3S3/4-M10
S	25	3/4"	350	19	19	45	30	33	42	22.2	47.6	65	52	16	M 10 x 30	25 x 3,53	50	0305182081	24-FEO-S25-3S3/4-M10
S	25	1 1/4"	280	27	20	55	41	43	50	30.2	58.7	79	73	24	M 12 x 35	37,7 x 3,53	85	0305192081	24-FEO-S25-3S11/4-M12
S	30	1"	350	25	25	47	36	33.5	45	26.2	52.4	70	59	14	M 10 x 30	32,92 x 3,53	50	0305202081	24-FEO-S30-3S1-M10
S	30	1 1/4"	280	27	25	57	41	43.5	50	30.2	58.7	79	73	24	M 12 x 35	37,7 x 3,53	85	0305212081	24-FEO-S30-3S11/4-M12
S	38	1 1/4"	280	27	28	59	41	43	50	30.2	58.7	79	73	24	M 12 x 35	37,7 x 3,53	85	0305222081	24-FEO-S38-3S11/4-M12
S	38	1 1/2"	210	32	32	64	50	48	55	35.7	69.9	94	83	19	M 12 x 35	47,22 x 3,53	85	0305232081	24-FEO-S38-3S11/2-M12

Nm = recommended tightening torques (Nm max.) for cylindrical bolts as spec. in ISO 4762 (10.9) for friction coefficient μ tot. 0.14.

Example for comp. : WFS33/18LOMDCF



Elbow flange couplings

With cutting ring connection and devided SAE flange
Hole pattern according to SAE J 518 C / ISO 6162
High-pressure series (6000 psi)

Standard O-ring material is NBR

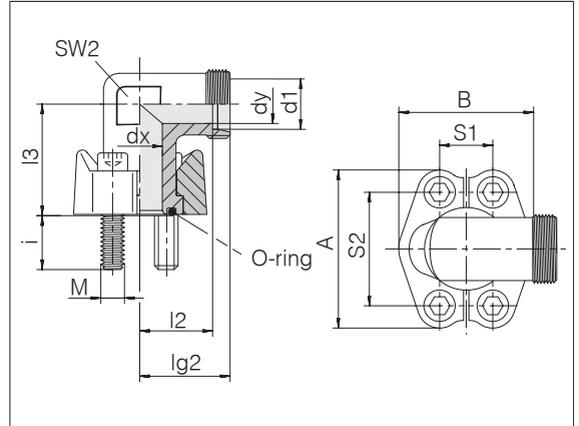

Series	Fl. size	PB	dx	dy	lg2	SW2	l2	l3	S1	S2	A	B	i	4 x cyl. screws	O-ring	Nm	Order-No.	Designation	
S	16	1/2"	400	12	12	38	24	29.5	39	18.3	40.5	56	47	14	M 8 x 30	18,66 x 3,53	25	0305352081	24-FEO-S16-6S1/2-M8
S	16	3/4"	400	17	12	45	32	36.5	48	23.8	50.8	71	60	16	M 10 x 35	25 x 3,53	50	0305362081	24-FEO-S16-6S3/4-M10
S	20	3/4"	400	17	16	46	32	35.5	48	23.8	50.8	71	60	16	M 10 x 35	25 x 3,53	50	0305372081	24-FEO-S20-6S3/4-M10
S	25	3/4"	400	17	18	48	32	36	48	23.8	50.8	71	60	16	M 10 x 35	25 x 3,53	50	0305382081	24-FEO-S25-6S3/4-M10
S	25	1"	400	24	20	53	41	41	60	27.8	57.2	81	70	21	M 12 x 45	32,92 x 3,53	85	0305392081	24-FEO-S25-6S1-M12
S	25	1 1/4"	400	24	24	58	46	46	68	31.8	66.7	95	78	23	M 14 x 50	37,7 x 3,53	135	0305412081	24-FEO-S25-6S11/4-M14
S	30	1"	400	24	24	55	41	41.5	60	27.8	57.2	81	70	21	M 12 x 45	32,92 x 3,53	85	0305402081	24-FEO-S30-6S1-M12
S	30	1 1/4"	400	31	25	58	46	44.5	68	31.8	66.7	95	78	23	M 14 x 50	37,7 x 3,53	135	0305422081	24-FEO-S30-6S11/4-M14
S	38	1 1/4"	315	31	30	61	46	45	68	31.8	66.7	95	78	23	M 14 x 50	37,7 x 3,53	135	0305442081	24-FEO-S38-6S11/4-M14
S	38	1 1/2"	315	36	32	72	50	56	76	36.5	79.4	113	95	25	M 16 x 55	47,22 x 3,53	210	0305462081	24-FEO-S38-6S11/2-M16

Nm = recommended tightening torques (Nm max.) for cylindrical bolts as spec. in ISO 4762 (10.9) for friction coefficient μ tot. 0.14.

Example for comp. :
WFS62/16SOMDCF

Flange couplings with cutting ring and square flange connection, Individual parts

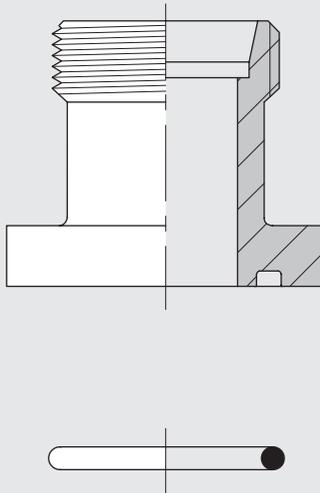

Straight flange couplings individual parts

With cutting ring and square flange connection

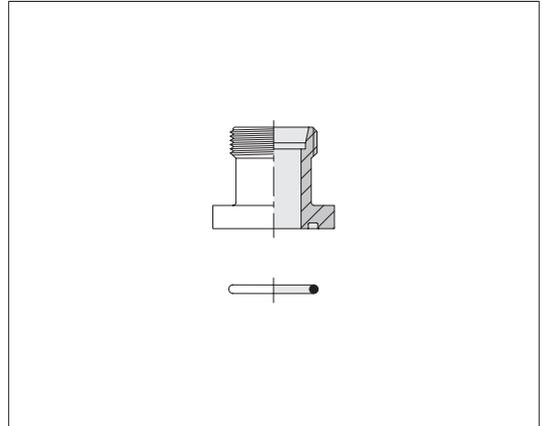

Series	PB	Hole circle Ø	kg/100 ca.	Order-No.	Designation
L 10	315	35	9.5	0795362000	24-FS-L10-HC35
L 12	315	35	9.7	0795372000	24-FS-L12-HC35
L 15	100	40	12.4	0795392000	24-FS-L15-HC40
L 15	250	35	10.2	0795382000	24-FS-L15-HC35
L 18	100	40	12.2	0795402000	24-FS-L18-HC40
L 22	100	40	12.3	0795412000	24-FS-L22-HC40
L 28	100	40	15.9	0795142000	24-FS-L28-HC40
L 28	100	55	30.4	0795902000	24-FS-L28-HC55
L 35	100	55	39.8	0795872000	24-FS-L35-HC55
S 16	315	35	16.4	0795102000	24-FS-S16-HC35

Elbow flange couplings individual parts

With cutting ring and square flange connection

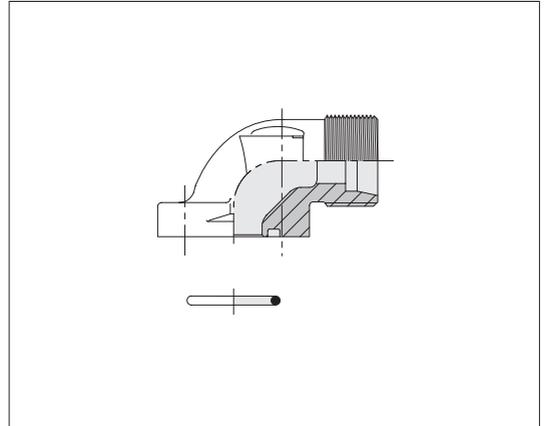

Series	PB	Hole circle Ø	kg/100 ca.	Order-No.	Designation
L 10	315	35	14.2	0795422000	24-FE-L10-HC35
L 12	315	35	15.7	0795622000	24-FE-L12-HC35
L 15	100	40	20.1	0795642000	24-FE-L15-HC40
L 15	250	35	15.0	0795632000	24-FE-L15-HC35
L 18	100	35	17.9	0795452000	24-FE-L18-HC35
L 18	100	40	16.9	0795432000	24-FE-L18-HC40
L 22	100	40	17.7	0795442000	24-FE-L22-HC40
L 28	100	40	26.0	0795152000	24-FE-L28-HC40
L 35	100	40	32.2	0795272000	24-FE-L35-HC40
L 35	100	55	46.6	0795172000	24-FE-L35-HC55
S 12	315	35	27.1	0795882000	24-FE-S12-HC35
S 16	315	35	17.3	0795252000	24-FE-S16-HC35
S 20	250	40	20.2	0795132000	24-FE-S20-HC40
S 20	250	55	44.9	0795182000	24-FE-S20-HC55
S 20	315	35	22.3	0795112000	24-FE-S20-HC35
S 25	250	55	49.1	0795892000	24-FE-S25-HC55
S 30	250	55	49.8	0795242000	24-FE-S30-HC55

Flange couplings with cutting ring connection and split SAE flange, individual parts

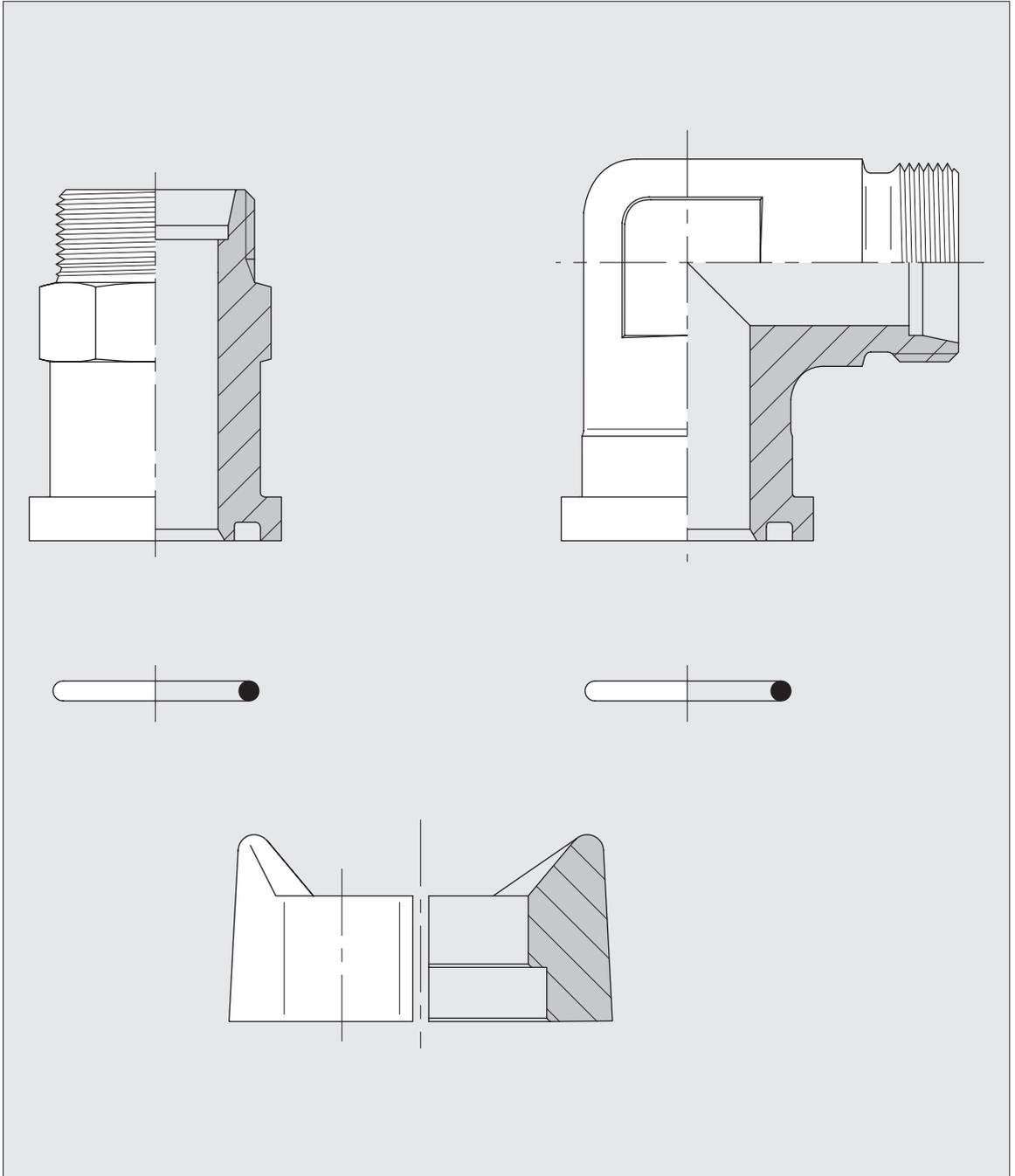

4

Straight / elbow flange couplings individual parts

With cutting ring connection and devided SAE flange
Hole pattern according to SAE J 518 C / ISO 6162
Standard series (3000 psi)

- 1 = One flange half
- 2 = Straight flange stub connector
- 3 = Elbow flange stud connector

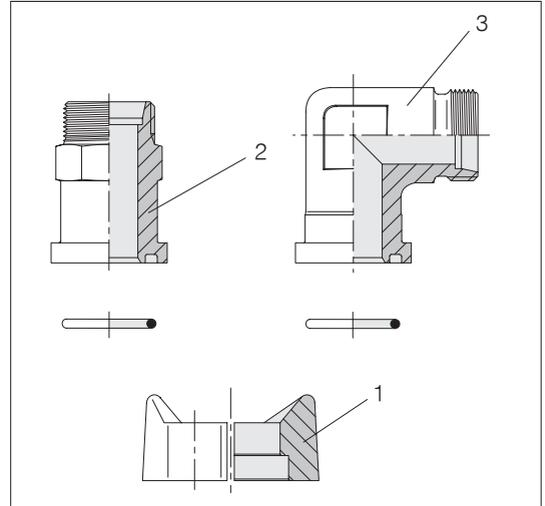

Series	Fl. size	kg/100 ca.	Order-No.	Designation 1	kg/100 ca.	Order-No.	Designation 2	kg/100 ca.	Order-No.	Designation 3
L	18 3/4"	8.9	0397792000	GP-FCS-3S3/4-D10,75	21.3	0396002000	24-FSX-L18-3S3/4	31.4	0396122000	24-FEX-L18-3S3/4
L	22 3/4"	8.9	0397792000	GP-FCS-3S3/4-D10,75	20.2	0396012000	24-FSX-L22-3S3/4	29.6	0396132000	24-FEX-L22-3S3/4
L	28 1"	11.0	0397802000	GP-FCS-3S1-D10,75	28.2	0396022000	24-FSX-L28-3S1	40.4	0396142000	24-FEX-L28-3S1
L	35 1 1/4"	14.6	0397812000	GP-FCS-3S11/4-D12,75	36.3	0396032000	24-FSX-L35-3S11/4	67.0	0396152000	24-FEX-L35-3S11/4
L	42 1 1/2"	22.8	0397822000	GP-FCS-3S11/2-D13,5	48.2	0396042000	24-FSX-L42-3S11/2	110.9	0396162000	24-FEX-L42-3S11/2
S	20 3/4"	8.9	0397792000	GP-FCS-3S3/4-D10,75	23.8	0396052000	24-FSX-S20-3S3/4	31.9	0396172000	24-FEX-S20-3S3/4
S	25 3/4"	8.9	0397792000	GP-FCS-3S3/4-D10,75	24.1	0396062000	24-FSX-S25-3S3/4	33.3	0396182000	24-FEX-S25-3S3/4
S	25 1 1/4"	14.6	0397812000	GP-FCS-3S11/4-D12,75	43.3	0396072000	24-FSX-S25-3S11/4	62.2	0396192000	24-FEX-S25-3S11/4
S	30 1"	11.0	0397802000	GP-FCS-3S1-D10,75	36.4	0396082000	24-FSX-S30-3S1	45.2	0396202000	24-FEX-S30-3S1
S	30 1 1/4"	14.6	0397812000	GP-FCS-3S11/4-D12,75	43.8	0396092000	24-FSX-S30-3S11/4	69.4	0396212000	24-FEX-S30-3S11/4
S	38 1 1/4"	14.6	0397812000	GP-FCS-3S11/4-D12,75	53.2	0396102000	24-FSX-S38-3S11/4	76.5	0396222000	24-FEX-S38-3S11/4
S	38 1 1/2"	22.8	0397822000	GP-FCS-3S11/2-D13,5	63.2	0396112000	24-FSX-S38-3S11/2	98.3	0396232000	24-FEX-S38-3S11/2

Straight / elbow flange couplings individual parts

With cutting ring connection and devided SAE flange
Hole pattern according to SAE J 518 C / ISO 6162
High-pressure series (6000 psi)

- 1 = One flange half
- 2 = Straight flange stub connector
- 3 = Elbow flange stud connector

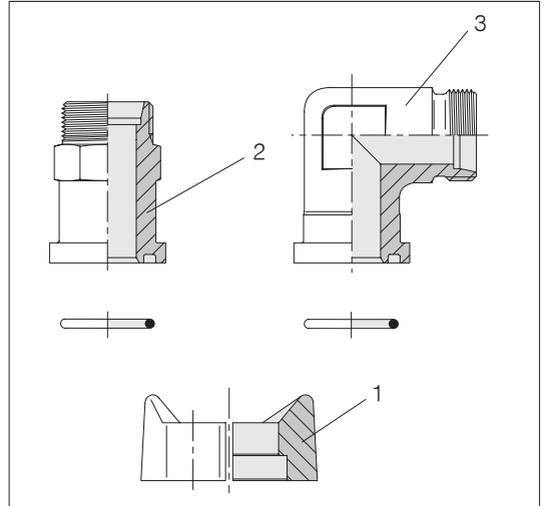

Series	Fl. size	kg/100 ca.	Order-No.	Designation 1	kg/100 ca.	Order-No.	Designation 2	kg/100 ca.	Order-No.	Designation 3
S	16 1/2"	8.2	0397862000	GP-FCS-6S1/2-D8,75				15.7	0396352000	24-FEX-S16-6S1/2
S	16 3/4"	16.2	0397872000	GP-FCS-6S3/4-D10,75	27.2	0396242000	24-FSX-S16-6S3/4	43.0	0396362000	24-FEX-S16-6S3/4
S	20 3/4"	16.2	0397872000	GP-FCS-6S3/4-D10,75	27.9	0396252000	24-FSX-S20-6S3/4	42.5	0396372000	24-FEX-S20-6S3/4
S	25 3/4"	16.2	0397872000	GP-FCS-6S3/4-D10,75	30.0	0396262000	24-FSX-S25-6S3/4	45.8	0396382000	24-FEX-S25-6S3/4
S	25 1"	25.5	0397882000	GP-FCS-6S1-D13	46.1	0396272000	24-FSX-S25-6S1	59.3	0396392000	24-FEX-S25-6S1
S	30 1"	25.5	0397882000	GP-FCS-6S1-D13	43.4	0396282000	24-FSX-S30-6S1	61.2	0396402000	24-FEX-S30-6S1
S	30 1 1/4"	38.8	0397892000	GP-FCS-6S11/4-D14,75	57.4	0396302000	24-FSX-S30-6S11/4	82.9	0396422000	24-FEX-S30-6S11/4
S	38 1 1/4"	38.8	0397892000	GP-FCS-6S11/4-D14,75	64.8	0396322000	24-FSX-S38-6S11/4	96.5	0396442000	24-FEX-S38-6S11/4
S	38 1 1/2"	67.1	0397902000	GP-FCS-6S11/2-D17	82.0	0396342000	24-FSX-S38-6S11/2	131.7	0396462000	24-FEX-S38-6S11/2

For O-rings, see
chapter 3.

Example for comp. :
FHS63CFX
GFS63/16SCFX
WFS63/16SCFX

ZAKO flared flanges with SAE flange connection

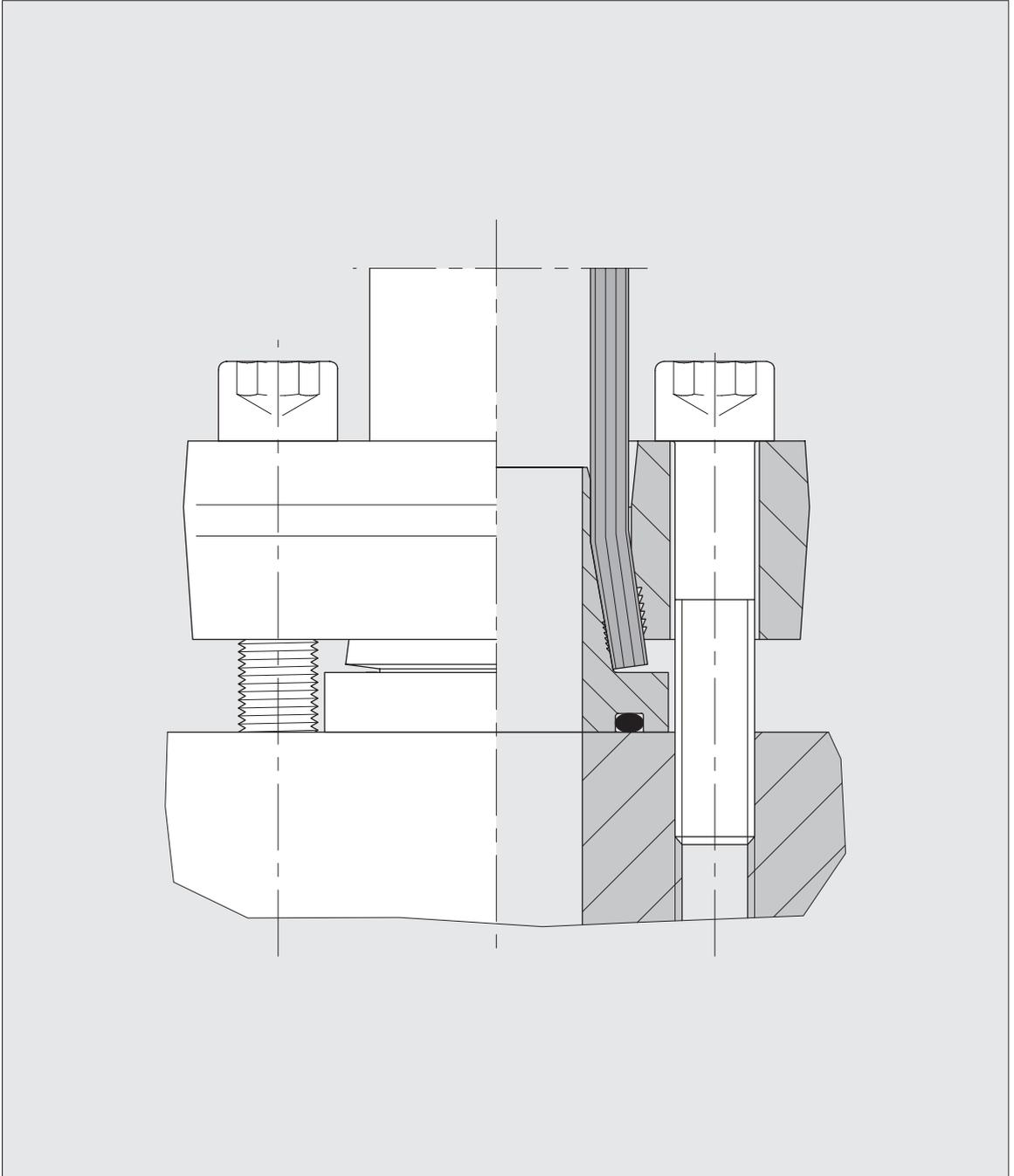

Connecting flange couplings ZAKO system

Hole pattern according to
SAE J 518 C / ISO 6162
Standard series (3000 psi)

Standard O-ring material is NBR

Permitted operating pressure (PB) 250 bar

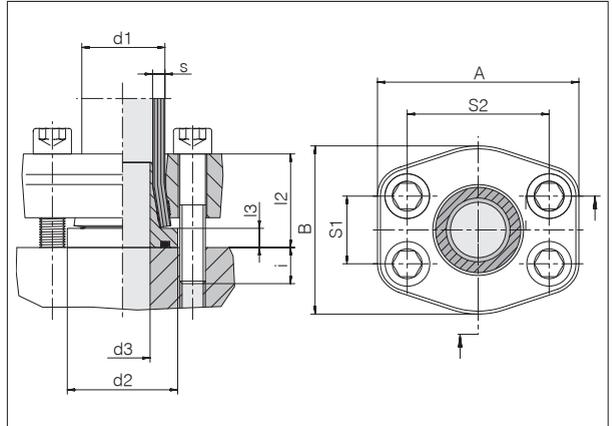

Tube d1 x s	Fl. size	d2	d3	l2 ca.	l3	S1	S2	A	B	i	4 x cyl. screws	Nm	kg/100 ca.	Order-No.	Designation
16 x 2	1/2"	30	10.5	32	8	17.5	38.1	55	45	13	M 8 x 45	35	43.9	0513001900	Z-TPO-16x2-3S1/2-M8-C19
16 x 2,5	1/2"	30	9.5	32	8	17.5	38.1	55	45	13	M 8 x 45	35	43.9	0513011900	Z-TPO-16x2,5-3S1/2-M8-C19
16 x 3	1/2"	30	8.5	32	8	17.5	38.1	55	45	13	M 8 x 45	35	43.9	0513291900	Z-TPO-16x3-3S1/2-M8-C19
20 x 2,5	3/4"	38	13.5	32	8	22.2	47.6	65	50	13	M 10 x 45	69	54.7	0513021900	Z-TPO-20x2,5-3S3/4-M10-C19
20 x 3	3/4"	38	12.5	32	8	22.2	47.6	65	50	13	M 10 x 45	69	54.8	0513031900	Z-TPO-20x3-3S3/4-M10-C19
25 x 3	3/4"	38	17	32.5	8.5	22.2	47.6	65	50	12.5	M 10 x 45	69	66.9	0513041900	Z-TPO-25x3-3S3/4-M10-C19
25 x 4	3/4"	38	15	32.5	8.5	22.2	47.6	65	50	12.5	M 10 x 45	69	67.3	0513221900	Z-TPO-25x4-3S3/4-M10-C19
30 x 4	1"	46	20	42.5	8.5	26.2	52.4	72	60	12.5	M 10 x 50	69	80.1	0513051900	Z-TPO-30x4-3S1-M10-C19
30 x 5	1"	46	17	42.5	8.5	26.2	52.4	72	60	12.5	M 10 x 50	69	81.3	0513251900	Z-TPO-30x5-3S1-M10-C19
38 x 4	1 1/4"	52	28	44	9	30.2	58.7	79	73	16	M 12 x 60	120	106.7	0513061900	Z-TPO-38x4-3S11/4-M12-C19
38 x 5	1 1/4"	52	26	44	9	30.2	58.7	79	73	16	M 12 x 60	120	107.3	0513281900	Z-TPO-38x5-3S11/4-M12-C19
42 x 2	1 1/4"	52	34	44	9	30.2	58.7	79	73	16	M 10 x 60	69	80.1	0513161900	Z-TPO-42x2-3S11/4-M10-C19
50 x 2,5	1 1/2"	63	42	46	10	35.7	69.9	94	83	14	M 12 x 60	120	136.3	0513081900	Z-TPO-50x2,5-3S11/2-M12-C19
50 x 5	1 1/2"	63	37	46	10	35.7	69.9	94	83	14	M 12 x 60	120	136.9	0513091900	Z-TPO-50x5-3S11/2-M12-C19
50 x 6	1 1/2"	63	35	46	10	35.7	69.9	94	83	14	M 12 x 60	120	136.8	0513101900	Z-TPO-50x6-3S11/2-M12-C19
50 x 8	1 1/2"	63	31	46	10	35.7	69.9	94	83	14	M 12 x 60	120	140.0	0513201900	Z-TPO-50x8-3S11/2-M12-C19
65 x 3	2"	75	55	60	11	42.9	77.8	102	97	15	M 12 x 75	120	189.0	0513111900	Z-TPO-65x3-3S2-M12-C19
65 x 4	2"	75	54	60	11	42.9	77.8	102	97	15	M 12 x 75	120	183.0	0513121900	Z-TPO-65x4-3S2-M12-C19
65 x 5	2"	75	52	60	11	42.9	77.8	102	97	15	M 12 x 75	120	186.3	0513131900	Z-TPO-65x5-3S2-M12-C19
80 x 3	3"	100	71	66	16	61.9	106.4	135	131	24	M 16 x 90	295	405.6	0513141900	Z-TPO-80x3-3S3-M16-C19

The pressure ratings stated by the tube manufacturers are the criteria for selecting tube dimensions.

ASME code states that a reduced operating pressure applies to flange sizes 2" and 3".

Nm = recommended tightening torques (Nm max.) for cylindrical bolts as spec. in DIN 912 (10.9) for friction coefficient μ tot. 0.14.

Example for comp. :
FE-1620-8/3



Connecting flange couplings ZAKO system

Hole pattern according to
SAE J 518 C / ISO 6162
Standard series (3000 psi)

Standard O-ring material is NBR

Permitted operating pressure (PB) 250 bar

Reducers

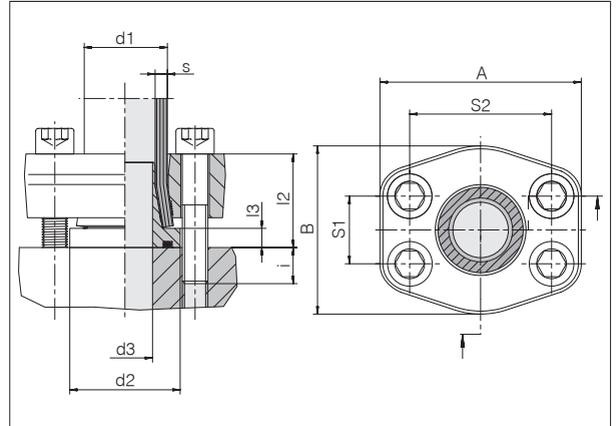

Tube d1 x s	Fl. size	d2	d3	l2 ca.	l3	S1	S2	A	B	i ca.	4 x cyl. screws	Nm	kg/100 ca.	Order-No.	Designation
25 x 3	1"	38	17	38.5	8.5	26.2	52.4	72	60	16.5	M 10 x 55	69	64.0	0513231900	Z-TPO-25x3-3S1-M10-C19
25 x 4	1"	38	15	38.5	8.5	26.2	52.4	72	60	16.5	M 10 x 55	69	64.6	0513241900	Z-TPO-25x4-3S1-M10-C19
30 x 4	1 1/4"	46	20	42	8.5	30.2	58.7	79	73	18	M 12 x 60	120	105.5	0513261900	Z-TPO-30x4-3S11/4-M12-C19
30 x 5	1 1/4"	46	17	43.5	8.5	30.2	58.7	79	73	16.5	M 12 x 60	120	105.7	0513271900	Z-TPO-30x5-3S11/4-M12-C19
50 x 2,5	2"	63	42	52.5	10	42.9	77.8	102	97	22.5	M 12 x 75	120	193.0	0513751900	Z-TPO-50x2,5-3S2-M12-C19
50 x 5	2"	63	37	53	10	42.9	77.8	102	97	22	M 12 x 75	120	193.2	0513761900	Z-TPO-50x5-3S2-M12-C19
50 x 6	2"	63	35	55	10	42.9	77.8	102	97	20	M 12 x 75	120	193.1	0513771900	Z-TPO-50x6-3S2-M12-C19
50 x 8	2"	63	31	56	10	42.9	77.8	102	97	19	M 12 x 75	120	197.4	0513781900	Z-TPO-50x8-3S2-M12-C19

4

The pressure ratings stated by the tube manufacturers are the criteria for selecting tube dimensions.

ASME code states that a reduced operating pressure applies to flange size 2".

Nm = recommended tightening torques (Nm max.) for cylindrical bolts as spec. in DIN 912 (10.9) for friction coefficient μ tot. 0.14.

Example for comp. :
FE-2530-16/3

Connecting flange couplings ZAKO system

Hole pattern according to
SAE J 518 C / ISO 6162
High pressure series (6000 psi)

Standard O-ring material is NBR

Permitted operating pressure (PB) 400 bar

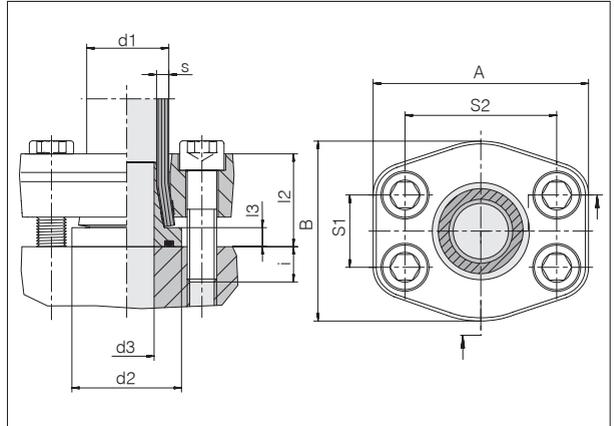

Tube d1 x s	Fl. size	d2	d3	l2 ca.	l3	S1	S2	A	B	i ca.	4 x cyl. screws	Nm	kg/100 ca.	Order-No.	Designation
16 x 2	1/2"	30	10.5	32	8	18.3	40.5	56	48	12	M 8 x 40	35	38.6	0513521900	Z-TPO-16x2-6S1/2-M8-C19
16 x 2,5	1/2"	30	9.5	32	8	18.3	40.5	56	48	12	M 8 x 40	35	38.6	0513301900	Z-TPO-16x2,5-6S1/2-M8-C19
16 x 3	1/2"	30	8.5	32	8	18.3	40.5	56	48	12	M 8 x 40	35	38.6	0513311900	Z-TPO-16x3-6S1/2-M8-C19
20 x 2,5	3/4"	38	13.5	37	8	23.9	50.8	71	60	13	M 10 x 40	69	69.2	0513531900	Z-TPO-20x2,5-6S3/4-M10-C19
20 x 3	3/4"	38	12.5	37	8	23.9	50.8	71	60	13	M 10 x 40	69	69.3	0513321900	Z-TPO-20x3-6S3/4-M10-C19
20 x 3,5	3/4"	38	11	37	8	23.9	50.8	71	60	13	M 10 x 40	69	69.6	0513331900	Z-TPO-20x3,5-6S3/4-M10-C19
25 x 3	3/4"	38	17	37.5	8.5	23.9	50.8	71	60	14.5	M 10 x 40	69	65.6	0513341900	Z-TPO-25x3-6S3/4-M10-C19
25 x 4	3/4"	38	15	37.5	8.5	23.9	50.8	71	60	14.5	M 10 x 40	69	66.0	0513351900	Z-TPO-25x4-6S3/4-M10-C19
30 x 4	1"	46	20	42.5	8.5	27.8	57.2	81	70	14.5	M 12 x 40	120	97.6	0513361900	Z-TPO-30x4-6S1-M12-C19
30 x 5	1"	46	17	42.5	8.5	27.8	57.2	81	70	14.5	M 12 x 40	120	98.7	0513371900	Z-TPO-30x5-6S1-M12-C19
38 x 4	1 1/4"	52	28	44	9	31.7	66.7	95	78	17.1	M 14 x 45	190	127.2	0513551900	Z-TPO-38x4-6S11/4-M14-C19
38 x 5	1 1/4"	52	26	44	9	31.7	66.7	95	78	17.1	M 14 x 45	190	127.0	0513381900	Z-TPO-38x5-6S11/4-M14-C19
38 x 6	1 1/4"	52	23	44	9	31.7	66.7	95	78	17.1	M 14 x 45	190	140.3	0513391900	Z-TPO-38x6-6S11/4-M14-C19
50 x 5	1 1/2"	63	37	56.5	10	36.5	79.4	113	95	22	M 16 x 60	295	230.8	0513561900	Z-TPO-50x5-6S11/2-M16-C19
50 x 6	1 1/2"	63	35	56.5	10	36.5	79.4	113	95	22	M 16 x 60	295	230.7	0513401900	Z-TPO-50x6-6S11/2-M16-C19
50 x 8	1 1/2"	63	31	56.5	10	36.5	79.4	113	95	22	M 16 x 60	295	233.1	0513411900	Z-TPO-50x8-6S11/2-M16-C19
65 x 8	2"	75	46	65	11	44.5	96.8	133	114	30	M 20 x 90	580	383.5	0513421900	Z-TPO-65x8-6S2-M20-C19

The pressure ratings stated by the tube manufacturers are the criteria for selecting tube dimensions.

Nm = recommended tightening torques (Nm max.) for cylindrical bolts as spec. in DIN 912 (10.9) for friction coefficient μ tot. 0.14.

Example for comp. :
FE-1620-8/6



Connecting flange couplings ZAKO system

Hole pattern according to
SAE J 518 C / ISO 6162
High pressure series (6000 psi)

Standard O-ring material is NBR

Permitted operating pressure (PB) 400 bar

Reducers

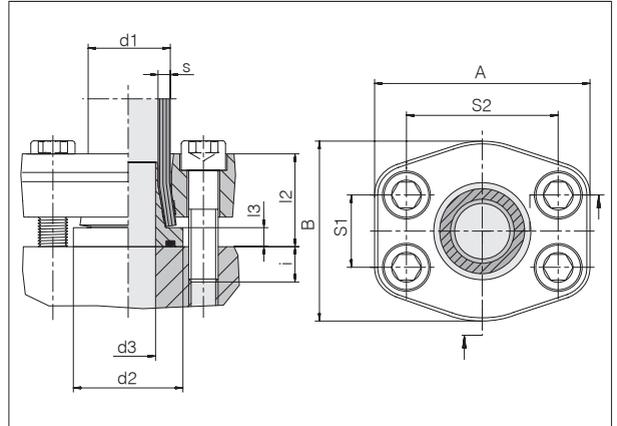

Tube d1 x s	Fl. size	d2	d3	l2 ca.	l3	S1	S2	A	B	i ca.	4 x cyl. screws	Nm	kg/100 ca.	Order-No.	Designation
38 x 5	1"	46	26	43	9	27.8	57.2	81	70	14	M 12 x 40	120	89.9	0513541900	Z-TPO-38x5-6S1-M12-C19
50 x 5	2"	75	37	58	10	44.5	96.8	133	114	32	M 20 x 90	580	438.5	0513571900	Z-TPO-50x5-6S2-M20-C19
50 x 6	2"	75	35	60	10	44.5	96.8	133	114	30	M 20 x 90	580	438.4	0513581900	Z-TPO-50x6-6S2-M20-C19
50 x 8	2"	75	31	61	10	44.5	96.8	133	114	34	M 20 x 90	580	440.7	0513431900	Z-TPO-50x8-6S2-M20-C19

The pressure ratings stated by the tube manufacturers are the criteria for selecting tube dimensions.

Nm = recommended tightening torques (Nm max.) for cylindrical bolts as spec. in DIN 912 (10.9) for friction coefficient μ tot. 0.14.

Example for comp. :
FE-3850-16/6

Tube connection flange couplings ZAKO system

Hole pattern according to
SAE J 518 C / ISO 6162
Standard series (3000 psi)

Standard O-ring material is NBR

Permitted operating pressure (PB) 250 bar

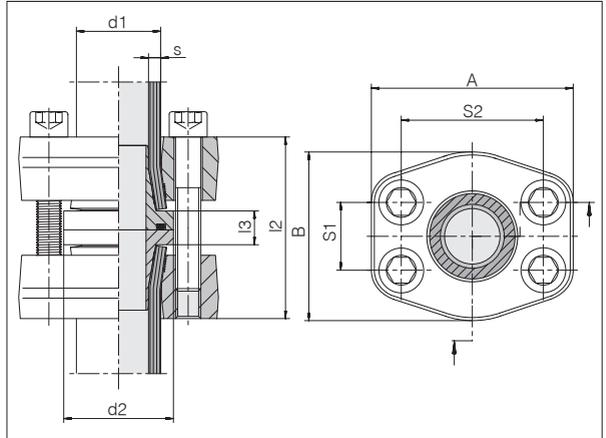

Tube d1 x s	Fl. size	d2	l2 ca.	l3	S1	S2	A	B	4 x cyl. screws	Nm	kg/100 ca.	Order-No.	Designation
16 x 2	1/2"	30	61.5	13.5	17.5	38.1	55	45	M 8 x 55	35	77.5	0514001900	Z-TTO-16x2-3S1/2-M8-C19
16 x 2,5	1/2"	30	61.5	13.5	17.5	38.1	55	45	M 8 x 55	35	77.5	0514011900	Z-TTO-16x2,5-3S1/2-M8-C19
16 x 3	1/2"	30	61.5	13.5	17.5	38.1	55	45	M 8 x 55	35	77.5	0514801900	Z-TTO-16x3-3S1/2-M8-C19
20 x 2,5	3/4"	38	61.5	13.5	22.2	47.6	65	50	M 10 x 55	69	96.6	0514021900	Z-TTO-20x2,5-3S3/4-M10-C19
20 x 3	3/4"	38	61.5	13.5	22.2	47.6	65	50	M 10 x 55	69	97.0	0514031900	Z-TTO-20x3-3S3/4-M10-C19
20 x 3,5	3/4"	38	61.5	13.5	22.2	47.6	65	50	M 10 x 55	69	97.4	0514811900	Z-TTO-20x3,5-3S3/4-M10-C19
25 x 3	3/4"	38	62	14	22.2	47.6	65	50	M 10 x 55	69	106.0	0514041900	Z-TTO-25x3-3S3/4-M10-C19
25 x 4	3/4"	38	62	14	22.2	47.6	65	50	M 10 x 55	69	106.4	0514821900	Z-TTO-25x4-3S3/4-M10-C19
30 x 4	1"	46	82.5	14.5	26.2	52.4	72	60	M 10 x 60	69	149.0	0514051900	Z-TTO-30x4-3S1-M10-C19
30 x 5	1"	46	82.5	14.5	26.2	52.4	72	60	M 10 x 60	69	151.2	0514851900	Z-TTO-30x5-3S1-M10-C19
38 x 4	1 1/4"	52	86	16	30.2	58.7	79	73	M 12 x 75	120	198.6	0514061900	Z-TTO-38x4-3S11/4-M12-C19
38 x 5	1 1/4"	52	86	16	30.2	58.7	79	73	M 12 x 75	120	197.1	0514071900	Z-TTO-38x5-3S11/4-M12-C19
38 x 6	1 1/4"	52	86	16	30.2	58.7	79	73	M 12 x 75	120	197.0	0514891900	Z-TTO-38x6-3S11/4-M12-C19
50 x 2,5	1 1/2"	63	89	17	35.7	69.9	94	83	M 12 x 75	120	255.8	0514081900	Z-TTO-50x2,5-3S11/2-M12-C19
50 x 5	1 1/2"	63	89	17	35.7	69.9	94	83	M 12 x 75	120	256.3	0514091900	Z-TTO-50x5-3S11/2-M12-C19
50 x 6	1 1/2"	63	89	17	35.7	69.9	94	83	M 12 x 75	120	255.8	0514101900	Z-TTO-50x6-3S11/2-M12-C19
50 x 8	1 1/2"	63	89	17	35.7	69.9	94	83	M 12 x 75	120	256.8	0514901900	Z-TTO-50x8-3S11/2-M12-C19
50 x 9	1 1/2"	63	89	17	35.7	69.9	94	83	M 12 x 75	120	257.1	0514911900	Z-TTO-50x9-3S11/2-M12-C19
65 x 3	2"	75	117	19	42.9	77.8	102	97	M 12 x 100	120	359.6	0514111900	Z-TTO-65x3-3S2-M12-C19
65 x 4	2"	75	117	19	42.9	77.8	102	97	M 12 x 100	120	353.2	0514121900	Z-TTO-65x4-3S2-M12-C19
65 x 5	2"	75	117	19	42.9	77.8	102	97	M 12 x 100	120	357.1	0514131900	Z-TTO-65x5-3S2-M12-C19
80 x 3	3"	100	129	29	61.9	106.4	135	131	M 16 x 110	295	756.0	0514141900	Z-TTO-80x3-3S3-M16-C19

The pressure ratings stated by the tube manufacturers are the criteria for selecting tube dimensions.

ASME code states that a reduced operating pressure applies to flange sizes 2" and 3".

Nm = recommended tightening torques (Nm max.) for cylindrical bolts as spec. in DIN 912 (10.9) for friction coefficient μ tot. 0.14.

Example for comp. :
FG-1620-8/3



Tube connection flange couplings ZAKO system

Hole pattern according to
SAE J 518 C / ISO 6162
High pressure series (6000 psi)

Standard O-ring material is NBR

Permitted operating pressure (PB) 400 bar

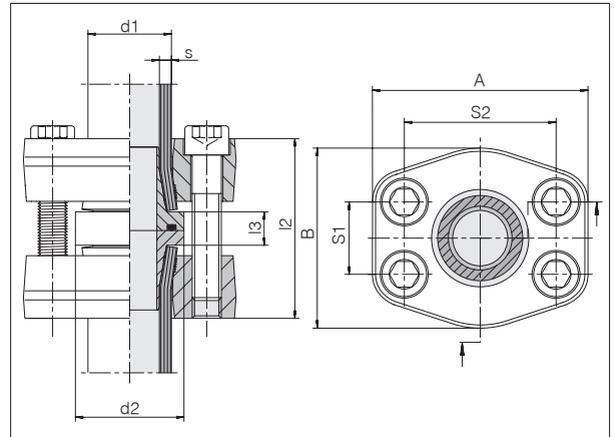

Tube d1 x s	Fl. size	d2	l2 ca.	l3	S1	S2	A	B	4 x cyl. screws	Nm	kg/100 ca.	Order-No.	Designation
16 x 2	1/2"	30	61.5	13.5	18.3	40.5	56	48	M 8 x 50	35	72.0	0514501900	Z-TTO-16x2-6S1/2-M8-C19
16 x 2,5	1/2"	30	61.5	13.5	18.3	40.5	56	48	M 8 x 50	35	72.0	0514301900	Z-TTO-16x2,5-6S1/2-M8-C19
16 x 3	1/2"	30	61.5	13.5	18.3	40.5	56	48	M 8 x 50	35	72.0	0514311900	Z-TTO-16x3-6S1/2-M8-C19
20 x 2,5	3/4"	38	71.5	13.5	23.9	50.8	71	60	M 10 x 50	69	132.5	0514511900	Z-TTO-20x2,5-6S3/4-M10-C19
20 x 3	3/4"	38	71.5	13.5	23.9	50.8	71	60	M 10 x 50	69	132.9	0514321900	Z-TTO-20x3-6S3/4-M10-C19
20 x 3,5	3/4"	38	71.5	13.5	23.9	50.8	71	60	M 10 x 50	69	133.2	0514331900	Z-TTO-20x3,5-6S3/4-M10-C19
25 x 3	3/4"	38	72	14	23.9	50.8	71	60	M 10 x 50	69	128.2	0514341900	Z-TTO-25x3-6S3/4-M10-C19
25 x 4	3/4"	38	72	14	23.9	50.8	71	60	M 10 x 50	69	128.9	0514351900	Z-TTO-25x4-6S3/4-M10-C19
30 x 4	1"	46	82.5	14.5	27.8	57.2	81	70	M 12 x 50	120	193.6	0514361900	Z-TTO-30x4-6S1-M12-C19
30 x 5	1"	46	82.5	14.5	27.8	57.2	81	70	M 12 x 50	120	195.8	0514371900	Z-TTO-30x5-6S1-M12-C19
38 x 4	1 1/4"	52	86	16	31.7	66.7	95	78	M 14 x 60	190	248.6	0514531900	Z-TTO-38x4-6S11/4-M14-C19
38 x 5	1 1/4"	52	86	16	31.7	66.7	95	78	M 14 x 60	190	248.9	0514381900	Z-TTO-38x5-6S11/4-M14-C19
38 x 6	1 1/4"	52	86	16	31.7	66.7	95	78	M 14 x 60	190	262.7	0514391900	Z-TTO-38x6-6S11/4-M14-C19
50 x 5	1 1/2"	63	110	17	36.5	79.4	113	95	M 16 x 75	295	442.6	0514541900	Z-TTO-50x5-6S11/2-M16-C19
50 x 6	1 1/2"	63	110	17	36.5	79.4	113	95	M 16 x 75	295	442.2	0514401900	Z-TTO-50x6-6S11/2-M16-C19
50 x 8	1 1/2"	63	110	17	36.5	79.4	113	95	M 16 x 75	295	444.7	0514411900	Z-TTO-50x8-6S11/2-M16-C19
50 x 9	1 1/2"	63	110	17	36.5	79.4	113	95	M 16 x 75	295	446.0	0514551900	Z-TTO-50x9-6S11/2-M16-C19
65 x 8	2"	75	127	19	44.5	96.8	133	114	M 20 x 110	580	699.0	0514421900	Z-TTO-65x8-6S2-M20-C19

The pressure ratings stated by the tube manufacturers are the criteria for selecting tube dimensions.

Nm = recommended tightening torques (Nm max.) for cylindrical bolts as spec. in DIN 912 (10.9) for friction coefficient μ tot. 0.14.

Example for comp. :
FG-1620-8/6

ZAKO flared flanges with square flange connection

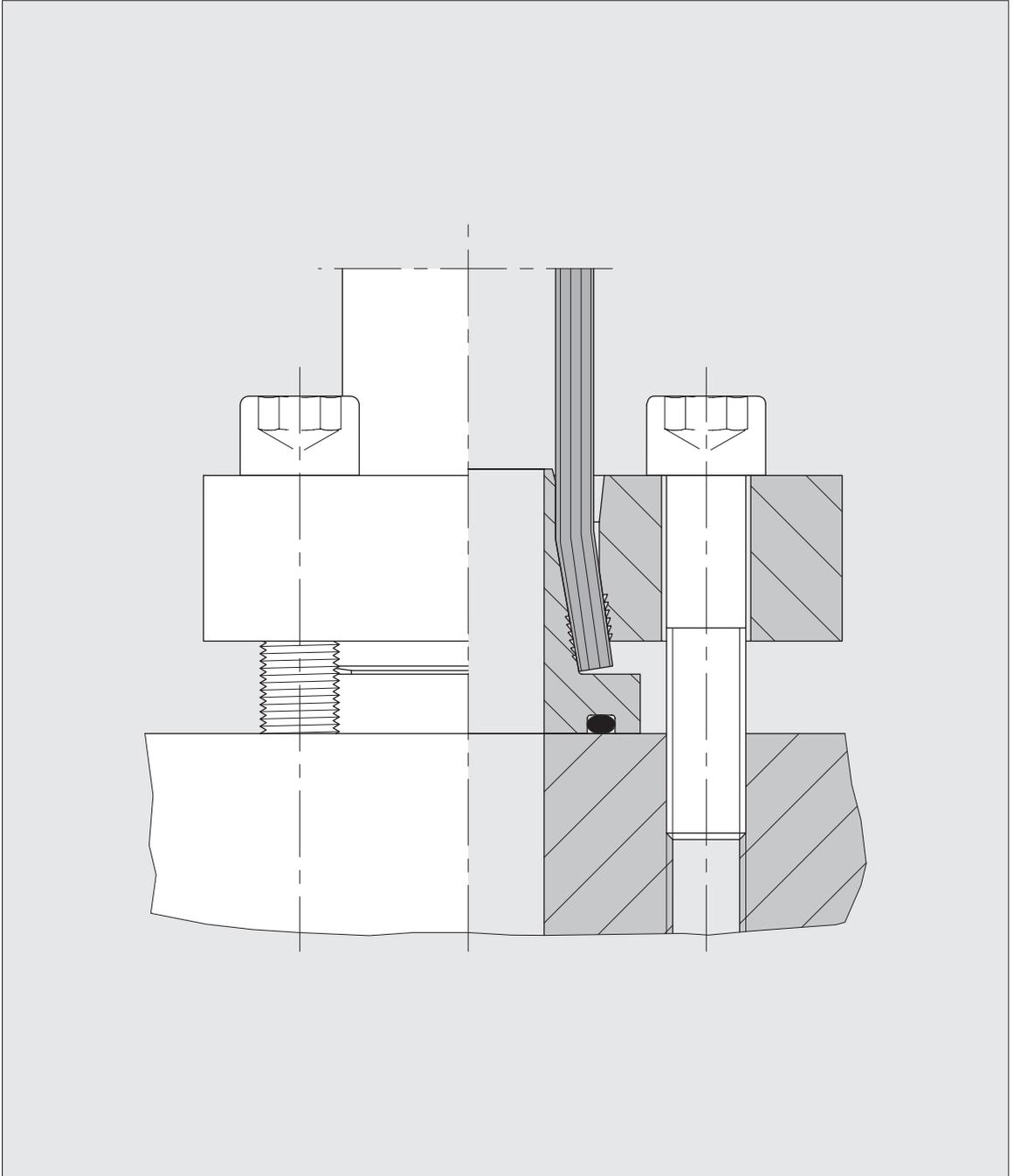

Connecting flange couplings ZAKO system

Hole pattern VOSS square flange high pressure series

Standard O-ring material is NBR

Permitted operating pressure (PB) 400 bar

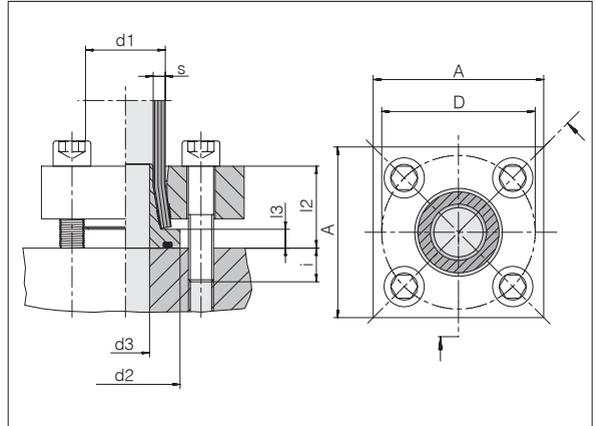

Tube d1 x s	NW	d2	d3	l2 ca.	l3	A	D	i ca.	4 x cyl. screws	Nm	kg/100 ca.	Order-No.	Designation
16 x 2	12	30	10.5	28	8	50	42	12	M 8 x 40	35	42.2	0515151900	Z-TPO-16x2-HC42-M8-C19
16 x 2,5	11	30	9.5	28	8	50	42	12	M 8 x 40	35	42.2	0513601900	Z-TPO-16x2,5-HC42-M8-C19
16 x 3	10	30	8.5	28	8	50	42	12	M 8 x 40	35	42.2	0513611900	Z-TPO-16x3-HC42-M8-C19
20 x 2,5	15	38	13.5	32	8	55	50	13	M 10 x 45	69	55.2	0515161900	Z-TPO-20x2,5-HC50-M10-C19
20 x 3	14	38	12.5	32	8	55	50	13	M 10 x 45	69	55.3	0513621900	Z-TPO-20x3-HC50-M10-C19
20 x 3,5	13	38	11	32	8	55	50	13	M 10 x 45	69	55.6	0513631900	Z-TPO-20x3,5-HC50-M10-C19
25 x 3	19	38	17	32.5	8.5	55	50	12.5	M 10 x 45	69	65.4	0513641900	Z-TPO-25x3-HC50-M10-C19
25 x 4	17	38	15	32.5	8.5	55	50	12.5	M 10 x 45	69	65.8	0513651900	Z-TPO-25x4-HC50-M10-C19
30 x 4	22	46	20	37.5	8.5	65	62	17.5	M 12 x 55	120	87.3	0513661900	Z-TPO-30x4-HC62-M12-C19
30 x 5	20	46	17	37.5	8.5	65	62	17.5	M 12 x 55	120	88.1	0513671900	Z-TPO-30x5-HC62-M12-C19
38 x 4	30	52	28	39	9	80	72	16	M 12 x 55	120	124.4	0515171900	Z-TPO-38x4-HC72-M12-C19
38 x 5	28	52	26	39	9	80	72	16	M 12 x 55	120	124.9	0513681900	Z-TPO-38x5-HC72-M12-C19
38 x 6	26	52	23	39	9	80	72	16	M 12 x 55	120	125.1	0513691900	Z-TPO-38x6-HC72-M12-C19
50 x 2,5	45	63	42	56	10	85	85	19	M 14 x 75	190	197.4	0515001900	Z-TPO-50x2,5-HC85-M14-C19
50 x 2,5	45	63	42	56	10	100	98	19	M 16 x 75	295	290.1	0515181900	Z-TPO-50x2,5-HC98-M16-C19
50 x 5	40	63	37	56	10	85	85	19	M 14 x 75	190	197.9	0515231900	Z-TPO-50x5-HC85-M14-C19
50 x 5	40	63	37	56	10	100	98	19	M 16 x 75	295	290.5	0515191900	Z-TPO-50x5-HC98-M16-C19
50 x 6	38	63	35	56	10	85	85	19	M 14 x 75	190	197.9	0515241900	Z-TPO-50x6-HC85-M14-C19
50 x 6	38	63	35	56	10	100	98	19	M 16 x 75	295	290.5	0513701900	Z-TPO-50x6-HC98-M16-C19
50 x 8	34	63	31	56	10	85	85	19	M 14 x 75	190	201.1	0515011900	Z-TPO-50x8-HC85-M14-C19
50 x 8	34	63	31	56	10	100	98	19	M 16 x 75	295	294.0	0513711900	Z-TPO-50x8-HC98-M16-C19
50 x 9	32	63	29	56	10	85	85	19	M 14 x 75	190	201.1	0515251900	Z-TPO-50x9-HC85-M14-C19
50 x 9	32	63	29	56	10	100	98	19	M 16 x 75	295	294.0	0515201900	Z-TPO-50x9-HC98-M16-C19

The pressure ratings stated by the tube manufacturers are the criteria for selecting tube dimensions.

Nm = recommended tightening torques (Nm max.) for cylindrical bolts as spec. in DIN 912 (10.9) for friction coefficient μ tot. 0.14.

Example for comp. :
FE-1620

Continued on following page



Connecting flange couplings ZAKO system

Hole pattern VOSS square flange high pressure series

Standard O-ring material is NBR

Permitted operating pressure (PB) 400 bar

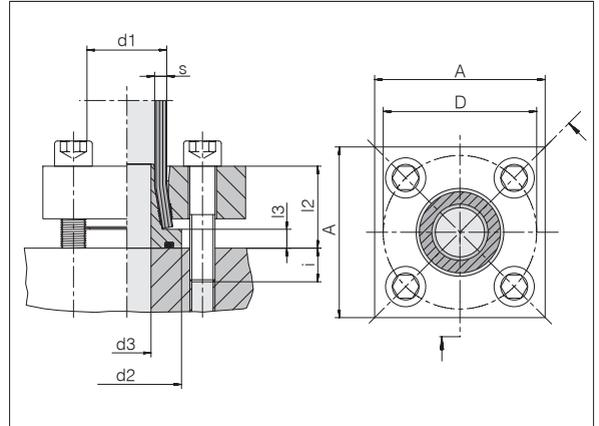

Tube d1 x s	NW	d2	d3	l2 ca.	l3	A	D	i ca.	4 x cyl. screws	Nm	kg/100 ca.	Order-No.	Designation
60 x 3	54	75	51	64	15	100	98	26	M 16 x 90	295	289.0	0515021900	Z-TPO-60x3-HC98-M16-C19
60 x 5	50	75	47	64	15	100	98	26	M 16 x 90	295	295.0	0515211900	Z-TPO-60x5-HC98-M16-C19
60 x 10	40	75	35	64	15	100	98	26	M 16 x 90	295	292.0	0515031900	Z-TPO-60x10-HC98-M16-C19
65 x 8	49	75	46	60	11	120	118	30	M 20 x 90	580	430.5	0513721900	Z-TPO-65x8-HC118-M20-C19
75 x 12,5	50	95	45	72	16	120	118	28	M 20 x 100	580	522.0	0513801900	Z-TPO-75x12,5-HC118-M20-C19
80 x 3	74	100	71	76	16	150	145	34	M 24 x 110	800	820.0	0515041900	Z-TPO-80x3-HC145-M24-C19
80 x 8	64	100	60	80	20	150	145	30	M 24 x 110	800	861.0	0515221900	Z-TPO-80x8-HC145-M24-C19
80 x 10	60	100	55	80	16	150	145	30	M 24 x 110	800	859.0	0513731900	Z-TPO-80x10-HC145-M24-C19
88 x 14	60	110	54	84	20	150	145	36	M 24 x 120	800	951.0	0513811900	Z-TPO-88x14-HC145-M24-C19
101,6 x 16	70	114	63.6	88.5	20	150	145	32	M 24 x 120	800	1132.0	0513831900	Z-TPO-101,6x16-HC145-M24-C19
114,3 x 17,5	80	140	73	92	20	180	175	38	M 30 x 130	1500	1400.0	0515641900	Z-TPO-114,3x17,5-HC175-M30-C19

The pressure ratings stated by the tube manufacturers are the criteria for selecting tube dimensions.

Nm = recommended tightening torques (Nm max.) for cylindrical bolts as spec. in DIN 912 (10.9) for friction coefficient μ tot. 0.14.

Example for comp. :
FE-6030

Tube connection flange couplings ZAKO system

Hole pattern VOSS square flange high pressure series

Standard O-ring material is NBR

Permitted operating pressure (PB) 400 bar

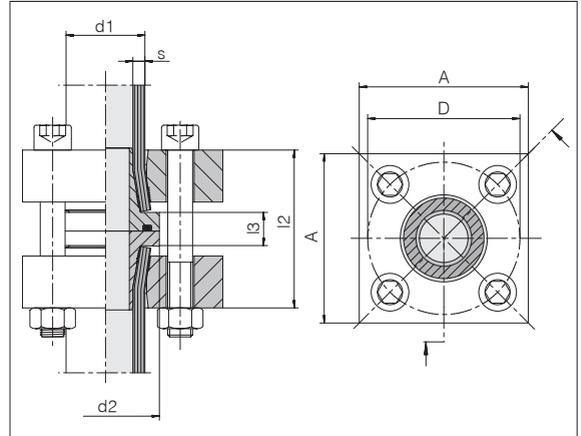

Tube d1 x s	NW	d2	l2 ca.	l3	A	D	4 x cyl. screws	Nm	kg/100 ca.	Order-No.	Designation
16 x 2	12	30	53.5	13.5	50	42	M 8 x 65	35	81.2	0515301900	Z-TTO-16x2-HC42-M8-C19
16 x 2,5	11	30	53.5	13.5	50	42	M 8 x 65	35	81.3	0514601900	Z-TTO-16x2,5-HC42-M8-C19
16 x 3	10	30	53.5	13.5	50	42	M 8 x 65	35	81.4	0514611900	Z-TTO-16x3-HC42-M8-C19
20 x 2,5	15	38	61.5	13.5	55	50	M 10 x 75	69	106.3	0515311900	Z-TTO-20x2,5-HC50-M10-C19
20 x 3	14	38	61.5	13.5	55	50	M 10 x 75	69	106.8	0514621900	Z-TTO-20x3-HC50-M10-C19
20 x 3,5	13	38	61.5	13.5	55	50	M 10 x 75	69	107.1	0514631900	Z-TTO-20x3,5-HC50-M10-C19
25 x 3	19	38	62	14	55	50	M 10 x 75	69	126.6	0514641900	Z-TTO-25x3-HC50-M10-C19
25 x 4	17	38	62	14	55	50	M 10 x 75	69	127.3	0514651900	Z-TTO-25x4-HC50-M10-C19
30 x 4	22	46	72.5	14.5	65	62	M 12 x 90	120	168.0	0514661900	Z-TTO-30x4-HC62-M12-C19
30 x 5	20	46	72.5	14.5	65	62	M 12 x 90	120	170.4	0514671900	Z-TTO-30x5-HC62-M12-C19
38 x 4	30	52	76	16	80	72	M 12 x 90	120	243.1	0515321900	Z-TTO-38x4-HC72-M12-C19
38 x 5	28	52	76	16	80	72	M 12 x 90	120	243.4	0514681900	Z-TTO-38x5-HC72-M12-C19
38 x 6	26	52	76	16	80	72	M 12 x 90	120	243.5	0514691900	Z-TTO-38x6-HC72-M12-C19
50 x 2,5	45	63	109	17	85	85	M 14 x 130	190	379.3	0515101900	Z-TTO-50x2,5-HC85-M14-C19
50 x 2,5	45	63	109	17	100	98	M 16 x 130	295	565.2	0515331900	Z-TTO-50x2,5-HC98-M16-C19
50 x 5	40	63	109	17	85	85	M 14 x 130	190	379.8	0515381900	Z-TTO-50x5-HC85-M14-C19
50 x 5	40	63	109	17	100	98	M 16 x 130	295	565.7	0515341900	Z-TTO-50x5-HC98-M16-C19
50 x 6	38	63	109	17	85	85	M 14 x 130	190	379.3	0515391900	Z-TTO-50x6-HC85-M14-C19
50 x 6	38	63	109	17	100	98	M 16 x 130	295	565.2	0514701900	Z-TTO-50x6-HC98-M16-C19
50 x 8	34	63	109	17	85	85	M 14 x 130	190	385.5	0515111900	Z-TTO-50x8-HC85-M14-C19
50 x 8	34	63	109	17	100	98	M 16 x 130	295	571.4	0514711900	Z-TTO-50x8-HC98-M16-C19

The pressure ratings stated by the tube manufacturers are the criteria for selecting tube dimensions.

Nm = recommended tightening torques (Nm max.) for cylindrical bolts as spec. in DIN 912 (10.9) for friction coefficient μ tot. 0.14.

Example for comp. :
FG-1620

Continued on following page



Tube connection flange couplings ZAKO system

Hole pattern VOSS square flange high pressure series

Standard O-ring material is NBR

Permitted operating pressure (PB) 400 bar

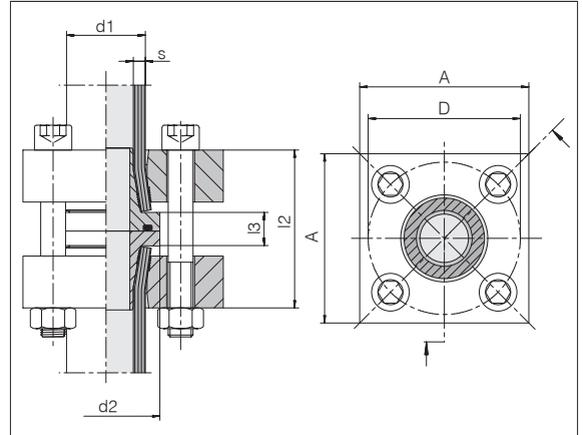

Tube d1 x s	NW	d2	l2 ca.	l3	A	D	4 x cyl. screws	Nm	kg/100 ca.	Order-No.	Designation
50 x 9	32	63	109	17	85	85	M 14 x 130	190	385.9	0515401900	Z-TTO-50x9-HC85-M14-C19
50 x 9	32	63	109	17	100	98	M 16 x 130	295	571.8	0515351900	Z-TTO-50x9-HC98-M16-C19
60 x 3	54	75	125	27	100	98	M 16 x 150	295	551.0	0515121900	Z-TTO-60x3-HC98-M16-C19
60 x 5	50	75	125	27	100	98	M 16 x 150	295	568.3	0515361900	Z-TTO-60x5-HC98-M16-C19
60 x 10	40	75	125	27	100	98	M 16 x 150	295	554.8	0515131900	Z-TTO-60x10-HC98-M16-C19
65 x 8	49	75	117	19	120	118	M 20 x 140	580	820.0	0514721900	Z-TTO-65x8-HC118-M20-C19
75 x 12,5	50	95	150	28	120	118	M 20 x 180	580	1003.0	0515411900	Z-TTO-75x12,5-HC118-M20-C19
80 x 3	74	100	134	29	150	145	M 24 x 180	800	1580.0	0515141900	Z-TTO-80x3-HC145-M24-C19
80 x 8	64	100	141	36	150	145	M 24 x 180	800	1658.0	0515371900	Z-TTO-80x8-HC145-M24-C19
80 x 10	60	100	141	36	150	145	M 24 x 180	800	1654.0	0514731900	Z-TTO-80x10-HC145-M24-C19
88 x 14	60	110	172	36	150	145	M 24 x 200	800	1796.0	0515421900	Z-TTO-88x14-HC145-M24-C19
101,6 x 16	70	114	174	36	150	145	M 24 x 200	800	1708.5	0514751900	Z-TTO-101,6x16-HC145-M24-C19
114,3 x 17,5	80	140	194	36	180	175	M 30 x 230	1500	2724.2	0515651900	Z-TTO-114,3x17,5-HC175-M30-C19

The pressure ratings stated by the tube manufacturers are the criteria for selecting tube dimensions.

Nm = recommended tightening torques (Nm max.) for cylindrical bolts as spec. in DIN 912 (10.9) for friction coefficient μ tot. 0.14.

Example for comp. :
FG-5090

ZAKO, individual parts

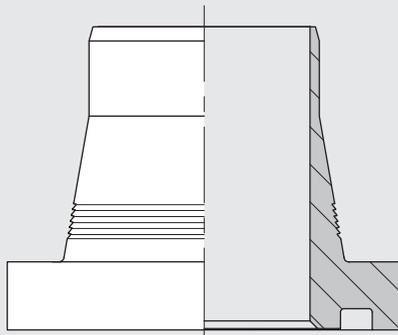
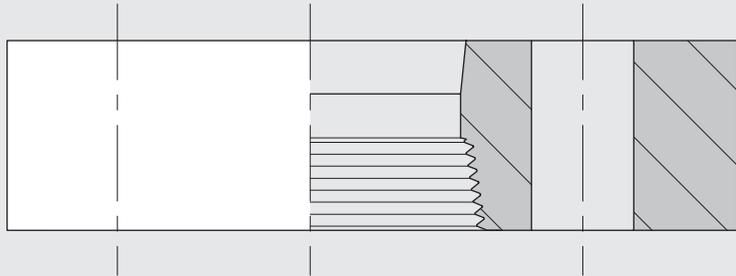

ZAKO ring with O-ring

O-ring is supplied in package, but not installed

Standard O-ring material is NBR

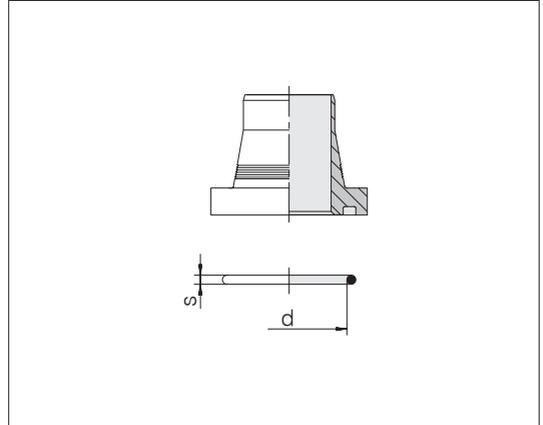

Tube d1 x s	Fl. size (SAE 3000 psi)	Fl. size (SAE 6000 psi)	Fl. size NW (square fl.)	kg/100 ca.	O-ring d x s	Order-No.	Designation
16 x 2	1/2"	1/2"	12	4.1	18.6 x 3.5	0036009900	Z-RGO-16x2-C19
16 x 2,5	1/2"	1/2"	11	4.1	18.6 x 3.5	0036029900	Z-RGO-16x2,5-C19
16 x 3	1/2"	1/2"	10	4.1	18.6 x 3.5	0036049900	Z-RGO-16x3-C19
20 x 2,5	3/4"	3/4"	15	6.5	25 x 3.5	0036069900	Z-RGO-20x2,5-C19
20 x 3	3/4"	3/4"	14	6.6	25 x 3.5	0036089900	Z-RGO-20x3-C19
20 x 3,5	3/4"	3/4"	13	6.9	25 x 3.5	0036109900	Z-RGO-20x3,5-C19
25 x 3	3/4", 1"	3/4"	19	6.9	25 x 3.5	0036129900	Z-RGO-25x3-C19
25 x 4	3/4", 1"	3/4"	17	7.2	25 x 3.5	0036149900	Z-RGO-25x4-C19
30 x 4	1", 1 1/4"	1"	22	10.3	32.9 x 3.5	0036169900	Z-RGO-30x4-C19
30 x 5	1", 1 1/4"	1"	20	11.5	32.9 x 3.5	0036189900	Z-RGO-30x5-C19
38 x 4	1 1/4"	1 1/4"	30	14.5	37.7 x 3.5	0036229900	Z-RGO-38x4-C19
38 x 5	1 1/4"	1 1/4"	28	15.0	37.7 x 3.5	0036249900	Z-RGO-38x5-C19
38 x 5	1"	1"		11.6	32.9 x 3.5	0036209900	Z-RGO-38x5-HD46-C19
38 x 6	1 1/4"	1 1/4"	26	15.2	37.7 x 3.5	0036269900	Z-RGO-38x6-C19
42 x 2	1 1/4"			15.9	37.7 x 3.5	0036609900	Z-RGO-42x2-C19
50 x 2,5	1 1/2", 2"		45	27.6	47.2 x 3.5	0036289900	Z-RGO-50x2,5-C19
50 x 5	1 1/2", 2"	1 1/2"	40	28.1	47.2 x 3.5	0036309900	Z-RGO-50x5
50 x 6	1 1/2", 2"	1 1/2"	38	28.0	47.2 x 3.5	0036329900	Z-RGO-50x6-C19
50 x 8	1 1/2", 2"	1 1/2"	34	31.3	47.2 x 3.5	0036349900	Z-RGO-50x8-C19
50 x 9	1 1/2", 2"	1 1/2"	32	31.0	47.2 x 3.5	0036369900	Z-RGO-50x9-C19
60 x 3			54	43.9	56.7 x 3.5	0036529900	Z-RGO-60x3-C19
60 x 5			50	50.0	56.7 x 3.5	0036589900	Z-RGO-60x5-C19
60 x 10			40	47.1	56.7 x 3.5	0036549900	Z-RGO-60x10-C19
60 x 10			50	88.7	60 x 5	0036819900	Z-RGO-60x10-HD95-C19

The pressure ratings stated by the tube manufacturers are the criteria for selecting tube dimensions.

ASME code states that a reduced operating pressure applies to flange size 2".

Example for comp. :
K-1620-8

Continued on following page

ZAKO ring with O-ring

O-ring is supplied in package, but not installed

Standard O-ring material is NBR

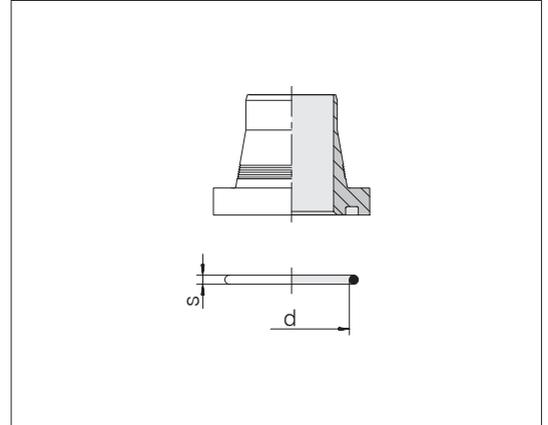

Tube d1 x s	Fl. size (SAE 3000 psi)	Fl. size (SAE 6000 psi)	Fl. size NW (square fl.)	kg/100 ca.	O-ring d x s	Order-No.	Designation
65 x 3	2"			35.2	60 x 3.5	0036389900	Z-RGO-65x3-C19
65 x 4	2"			28.8	60 x 3.5	0036409900	Z-RGO-65x4-C19
65 x 5	2"			32.6	56.7 x 3.5	0036429900	Z-RGO-65x5-C19
65 x 8		2"	49	47.1	56.7 x 3.5	0036449900	Z-RGO-65x8-C19
75 x 12,5			50	99.0	60 x 5	0036629900	Z-RGO-75x12,5-C19
75 x 12,5			60	150.0	75 x 5	0036809900	Z-RGO-75x12,5-HD110-C19
80 x 3	3"		74	86.9	85,3 x 3.5	0036489900	Z-RGO-80x3-C19
80 x 8			64	128.1	75 x 5	0036569900	Z-RGO-80x8-C19
80 x 10			60	126.3	75 x 5	0036509900	Z-RGO-80x10-C19
88 x 14			60	158.0	75 x 5	0036649900	Z-RGO-88x14-C19
101,6 x 16			70	172.0	80 x 5	0036869900	Z-RGO-101,6x16-C19
114,3 x 17,5			80	260.0	95 x 5	0036989900	Z-RGO-114,3x17,5-C19

The pressure ratings stated by the tube manufacturers are the criteria for selecting tube dimensions.

ASME code states that a reduced operating pressure applies to flange sizes 2" and 3".

Example for comp. :
K-6530-8

ZAKO ring

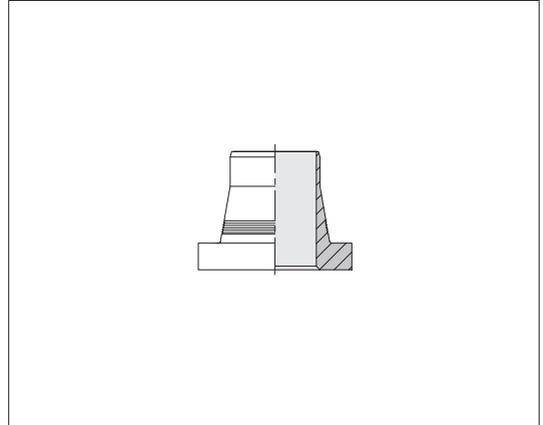

Tube d1 x s	Fl. size (SAE 3000 psi)	Fl. size (SAE 6000 psi)	Fl. size NW (square fl.)	kg/100 ca.	Order-No.	Designation
16 x 2	1/2"	1/2"	12	3.3	0036011900	Z-R-16x2-C19
16 x 2,5	1/2"	1/2"	11	3.4	0036031900	Z-R-16x2,5-C19
16 x 3	1/2"	1/2"	10	3.5	0036051900	Z-R-16x3-C19
20 x 2,5	3/4"	3/4"	15	5.3	0036071900	Z-R-20x2,5-C19
20 x 3	3/4"	3/4"	14	5.7	0036091900	Z-R-20x3-C19
20 x 3,5	3/4"	3/4"	13	5.7	0036111900	Z-R-20x3,5-C19
25 x 3	3/4"	3/4"	19	5.6	0036131900	Z-R-25x3-C19
25 x 4	3/4"	3/4"	17	5.9	0036151900	Z-R-25x4-C19
30 x 4	1"	1"	22	8.8	0036171900	Z-R-30x4-C19
30 x 5	1"	1"	20	9.9	0036191900	Z-R-30x5-C19
38 x 4	1 1/4"	1 1/4"	30	13.9	0036231900	Z-R-38x4-C19
38 x 5		1"		11.0	0036211900	Z-R-38x5-HD46-C19
38 x 5	1 1/4"	1 1/4"		13.7	0036251900	Z-R-38x5-C19
38 x 6	1 1/4"	1 1/4"	26	13.6	0036271900	Z-R-38x6-C19
42 x 2	1 1/4"			15.0	0036611900	Z-R-42x2-C19
50 x 2,5	1 1/2"		45	24.9	0036291900	Z-R-50x2,5-C19
50 x 5	1 1/2"	1 1/2"	40	24.9	0036311900	Z-R-50x5-C19
50 x 6	1 1/2"	1 1/2"	38	24.4	0036331900	Z-R-50x6-C19
50 x 8	1 1/2"	1 1/2"	34	27.4	0036351900	Z-R-50x8-C19
50 x 9	1 1/2"	1 1/2"	32	27.1	0036371900	Z-R-50x9-C19
60 x 3			54	40.0	0036531900	Z-R-60x3-C19
60 x 5			50	51.0	0036591900	Z-R-60x5-C19
60 x 10			40	40.0	0036551900	Z-R-60x10-C19
65 x 3	2"			32.4	0036391900	Z-R-65x3-C19
65 x 4	2"			26.9	0036411900	Z-R-65x4-C19
65 x 5	2"			32.0	0036431900	Z-R-65x5-C19
65 x 8	2"	2"		42.6	0036451900	Z-R-65x8-C19

The pressure ratings stated by the tube manufacturers are the criteria for selecting tube dimensions.

ASME code states that a reduced operating pressure applies to flange size 2".

Example for comp.:
KO-1620-8

Continued on following page



ZAKO ring

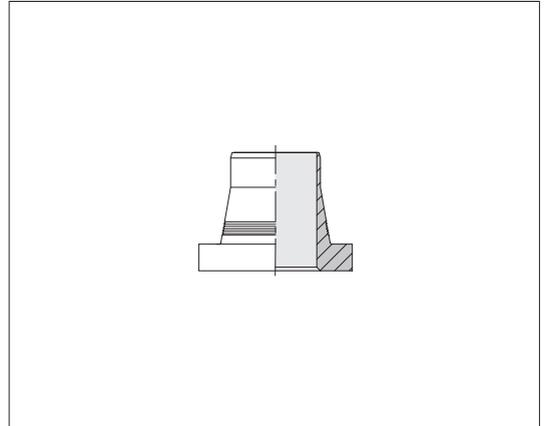

Tube d1 x s	Fl. size (SAE 3000 psi)	Fl. size (SAE 6000 psi)	Fl. size NW (square fl.)	kg/100 ca.	Order-No.	Designation
75 x 12,5			50	94.0	0036631900	Z-R-75x12,5-C19
80 x 3	3"			79.8	0036491900	Z-R-80x3-C19
80 x 8			64	122.3	0036571900	Z-R-80x8-C19
80 x 10			60	120.1	0036511900	Z-R-80x10-C19
88 x 14			60	154.0	0036651900	Z-R-88x14-C19
101,6 x 16			70	154.0	0036871900	Z-R-101,6x16-C19
114,3 x 17,5			80	230.0	0036991900	Z-R-114,3x17,5-C19

4

The pressure ratings stated by the tube manufacturers are the criteria for selecting tube dimensions.

ASME code states that a reduced operating pressure applies to flange size 3".

Example for comp. :
KO-75125-8

SAE flange ZAKO

Hole pattern according to SAE J 518 C / ISO 6162

Part 1: standard series (3000 psi)
Permitted operating pressure (PB) 250 bar

Part 2: high-pressure series (6000 psi)
Permitted operating pressure (PB) 400 bar

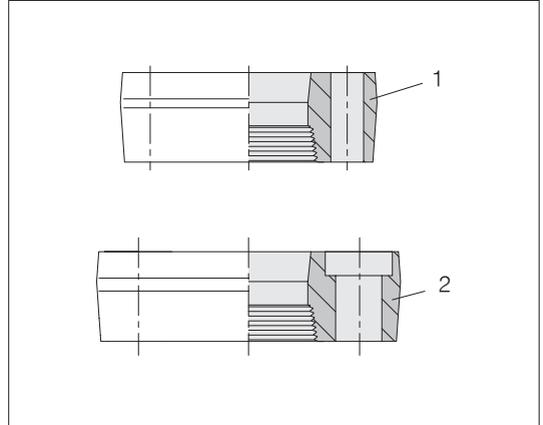

Tube OD	Fl. size (SAE 3000 psi)	Fl. size (SAE 6000 psi)	kg/100 ca.	Order-No.	Designation
16		1/2"	26.1	0510201900	Z-FPH-16-6S1/2-D9-C19
16	1/2"		30.6	0510001900	Z-FPH-16-3S1/2-D9-C19
20		3/4"	49.4	0510211900	Z-FPH-20-6S3/4-D11-C19
20	3/4"		33.7	0510011900	Z-FPH-20-3S3/4-D11-C19
25	1"		45.5	0510041900	Z-FPH-30/25-3S1-D11-C19
25		3/4"	45.5	0510221900	Z-FPH-25-6S3/4-D11-C19
25	3/4"		45.5	0510021900	Z-FPH-25-3S3/4-D11-C19
30		1"	68.7	0510231900	Z-FPH-30-6S1-D13,5-C19
30	1 1/4"		69.8	0510081900	Z-FPH-30-3S11/4-D13,5-C19
30	1"		54.1	0510051900	Z-FPH-30-3S1-D11-C19
38		1 1/4"	86.1	0510251900	Z-FPH-38-6S11/4-D15,5-C19
38		1"	59.6	0510241900	Z-FPH-38-6S1-D13,5-C19
38	1 1/4"		66.8	0510101900	Z-FPH-38-3S11/4-D13,5-C19
38	1"		54.1	0510061900	Z-FPH-38-3S1-D10,5-C19
42	1 1/4"		65.8	0510161900	Z-FPH-42-3S11/4-D11-C19
50		1 1/2"	154.0	0510281900	Z-FPH-50-6S11/2-D17,5-C19
50		2"	304.0	0510321900	Z-FPH-50-6S2-D22-C19
50	1 1/2"		83.3	0510111900	Z-FPH-50-3S11/2-D13,5-C19
50	2"		136.1	0510151900	Z-FPH-50-3S2-D13,5-C19
65		2"	248.3	0510301900	Z-FPH-65-6S2-D22-C19
65	2"		123.4	0510121900	Z-FPH-65-3S2-D13,5-C19
80	3"		250.7	0510141900	Z-FPH-80-3S3-D17,5-C19

The pressure ratings stated by the tube manufacturers are the criteria for selecting tube dimensions.

ASME code states that a reduced operating pressure applies to flange sizes 2" and 3" (3000 psi).

Example for comp. :
FE-1600-8/3
FE-1600-8/6



SAE counterflange ZAKO

Hole pattern according to SAE J 518 C / ISO 6162

Part 1: standard series (3000 psi)
Permitted operating pressure (PB) 250 bar

Part 2: high-pressure series (6000 psi)
Permitted operating pressure (PB) 400 bar

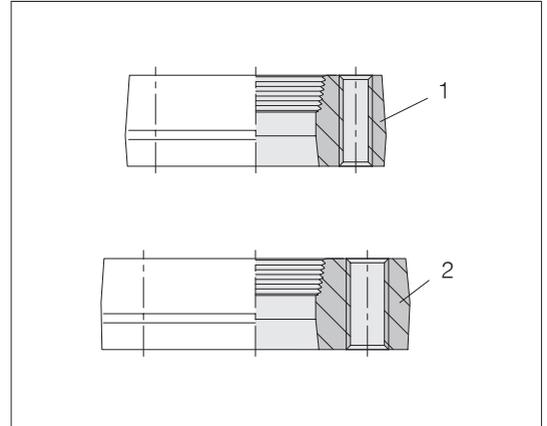

Tube OD	Fl. size (SAE 3000 psi)	Fl. size (SAE 6000 psi)	kg/100 ca.	Order-No.	Designation
16		1/2"	28.5	0510701900	Z-FPT-16-6S1/2-IM8-C19
16	1/2"		28.6	0510501900	Z-FPT-16-3S1/2-IM8-C19
20		3/4"	55.7	0510711900	Z-FPT-20-6S3/4-IM10-C19
20	3/4"		34.0	0510511900	Z-FPT-20-3S3/4-IM10-C19
25		3/4"	52.6	0510721900	Z-FPT-25-6S3/4-IM10-C19
25	3/4"		30.8	0510521900	Z-FPT-25-3S3/4-IM10-C19
30		1"	82.0	0510731900	Z-FPT-30-6S1-IM12-C19
30	1 1/4"		75.5	0510621900	Z-FPT-30-3S1 1/4-IM10-C19
30	1"		57.7	0510551900	Z-FPT-30-3S1-IM10-C19
38		1 1/4"	100.5	0510751900	Z-FPT-38-6S1 1/4-IM14-C19
38		1"	70.1	0510741900	Z-FPT-38-6S1-IM12-C19
38	1 1/4"		73.4	0510571900	Z-FPT-38-3S1 1/4-IM12-C19
42	1 1/4"		48.0	0510631900	Z-FPT-42-3S1 1/4-IM10-C19
50		1 1/2"	177.2	0510761900	Z-FPT-50-6S1 1/2-IM16-C19
50	1 1/2"		90.0	0510581900	Z-FPT-50-3S1 1/2-IM12-C19
65		2"	253.1	0510771900	Z-FPT-65-6S2-IM20-C19
65	2"		129.4	0510591900	Z-FPT-65-3S2-IM12-C19
80	3"		257.9	0510611900	Z-FPT-80-3S3-IM16-C19

The pressure ratings stated by the tube manufacturers are the criteria for selecting tube dimensions.

ASME code states that a reduced operating pressure applies to flange sizes 2" and 3" (3000 psi).

Example for comp. :
FV-1600-8/3
FV-1600-8/6

Square flange ZAKO

Hole pattern VOSS square flange high pressure series

Permitted operating pressure (PB) 400 bar

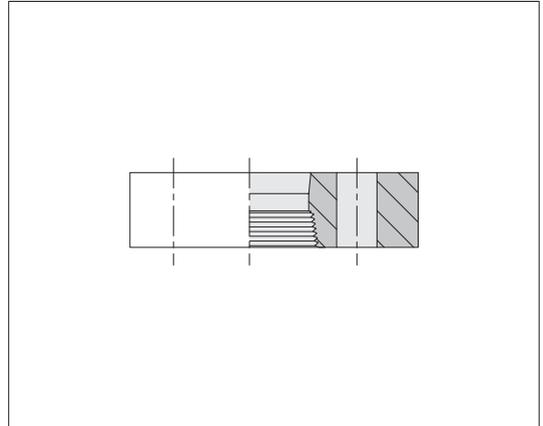

Tube OD	NW	kg/100 ca.	Order-No.	Designation
16	10, 11, 12	30.6	0511001900	Z-FPH-16-HC42-D9-C19
20	13, 14, 15	35.2	0511011900	Z-FPH-20-HC50-D11-C19
25	17, 19	45.0	0511021900	Z-FPH-25-HC50-D11-C19
30	20, 22	54.8	0511031900	Z-FPH-30-HC62-D13,5-C19
38	26, 28, 30	87.7	0511041900	Z-FPH-38-HC72-D13,5-C19
50	32, 34, 38, 40, 45	129.0	0511221900	Z-FPH-50-HC85-D15,5-C19
50	32, 34, 38, 40, 45	207.7	0511051900	Z-FPH-50-HC98-D17,5-C19
60	40	383.7	0511251900	Z-FPH-75/60-HC118-D22-C19
60	40, 50, 54	182.2	0511231900	Z-FPH-60-HC98-D17,5-C19
65	49	280.2	0511061900	Z-FPH-65-HC118-D22-C19
75	50	307.0	0511081900	Z-FPH-75-HC118-D22-C19
75	50	584.0	0511241900	Z-FPH-88/75-HC145-D26-C19
80	60, 64, 74	552.0	0511071900	Z-FPH-80-HC145-D26-C19
88	60	576.0	0511091900	Z-FPH-88-HC145-D26-C19
101.6	70	648.0	0511131900	Z-FPH-101,6-HC145-D26-C19
114.3	80	760.0	0511411900	Z-FPH-114,3-HC175-D33-C19

The pressure ratings stated by the tube manufacturers are the criteria for selecting tube dimensions.

ASME code states that a reduced operating pressure applies to flange size NW 40
Z-FPH-75/60-HC118-D22-C19

Example for comp. :
FE-1600



ZAKO LP flared flange with SAE flange connection

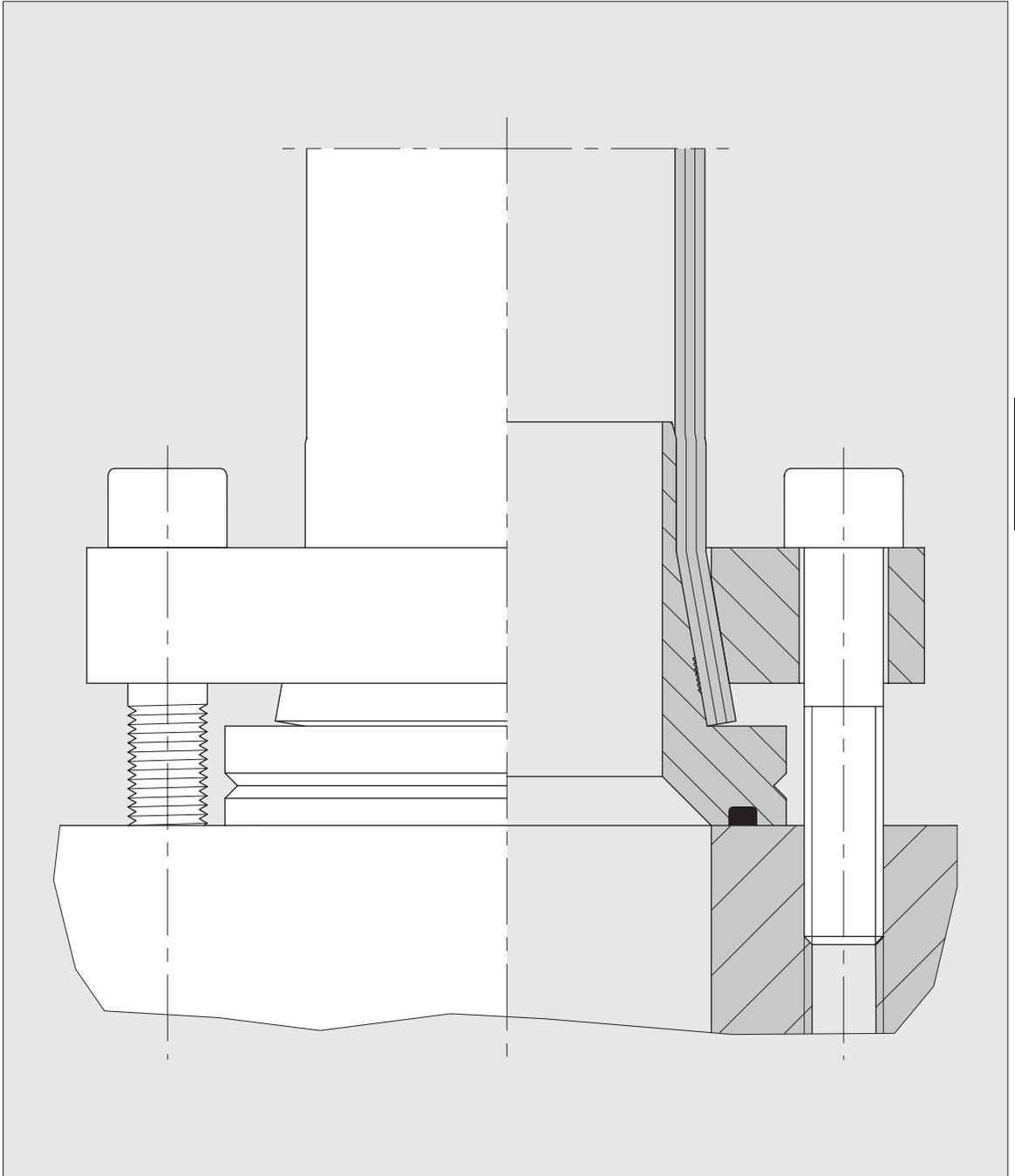

Connecting flange couplings ZAKO LP system

Hole pattern according to SAE J 518 C / ISO 6162-1

Standard O-ring material is NBR

Permitted operating pressure (PB) 60 bar

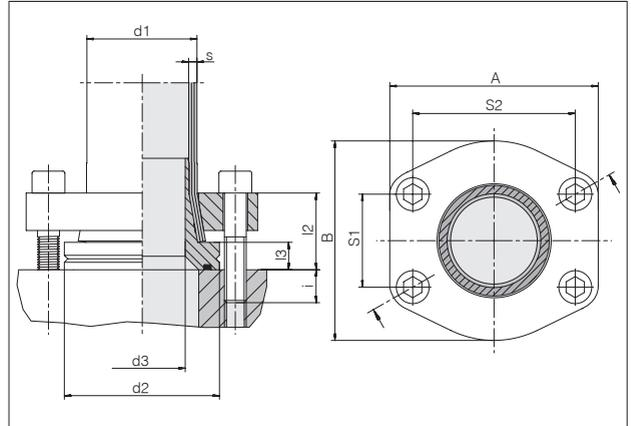

Tube d1 x s	NW	d2	d3	l2 ca.	l3	S1	S2	A	B	i ca.	4 x cyl. screws	Nm	kg/100 ca.	Order-No.	Designation
48,3 x 3,2	1 1/2"	63	39	35	10	35.7	69.9	94	83	15.5	M 12 x 50	85	82.6	0518602000	Z-TPO-LP48,3x3,2-3S11/2-M12
48,3 x 4	1 1/2"	63	36.5	35	10	35.7	69.9	94	83	15.5	M 12 x 50	85	85.1	0518622000	Z-TPO-LP48,3x4-3S11/2-M12
60,3 x 3,6	2"	72	49	42	15	42.9	77.8	102	97	18	M 12 x 60	85	109.8	0518802000	Z-TPO-LP60,3x3,6-3S2-M12
60,3 x 3,6	2 1/2"	85	49	42	15	50.8	88.9	114	109	18	M 12 x 60	85	161.8	0518642000	Z-TPO-LP60,3x3,6-3S21/2-M12
60,3 x 4,5	2 1/2"	85	47.5	42	15	50.8	88.9	114	109	18	M 12 x 60	85	149.5	0518662000	Z-TPO-LP60,3x4,5-3S21/2-M12
76,1 x 3,6	3"	100	65.5	50	16	61.9	106.4	135	131	20	M 16 x 70	210	262.2	0518682000	Z-TPO-LP76,1x3,6-3S3-M16
76,1 x 4,5	3"	100	63.5	50	16	61.9	106.4	135	131	20	M 16 x 70	210	216.8	0518702000	Z-TPO-LP76,1x4,5-3S3-M16
88,9 x 3,6	3 1/2"	114	78	56	20	69.9	120.7	152	140	19	M 16 x 75	210	341.0	0518722000	Z-TPO-LP88,9x3,6-3S31/2-M16
88,9 x 5	3 1/2"	114	74.5	56	20	69.9	120.7	152	140	19	M 16 x 75	210	347.2	0518742000	Z-TPO-LP88,9x5-3S31/2-M16
114,3 x 3,6	4"	130	102	62	20	77.8	130.2	162	152	28	M 16 x 90	210	442.1	0518932000	Z-TPO-LP114,3x3,6-3S4-M16
114,3 x 6,3	4"	130	96	62	20	77.8	130.2	162	152	28	M 16 x 90	210	456.1	0518952000	Z-TPO-LP114,3x6,3-3S4-M16

Nm = recommended tightening
torques (Nm max.) for
cylindrical bolts as spec. in DIN 912
(8.8) for friction coefficient μ tot. 0.14.

Tube connection flange couplings ZAKO LP system

Hole pattern according to SAE J 518 C / ISO 6162-1

Standard O-ring material is NBR

Permitted operating pressure (PB) 60 bar

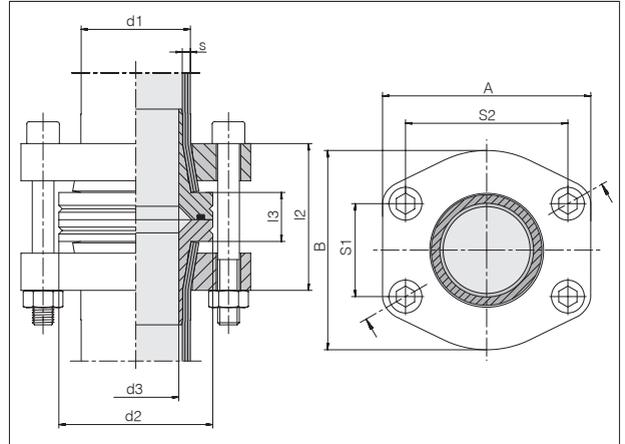

Tube d1 x s	NW	d2	d3	l2 ca.	l3	S1	S2	A	B	4 x cyl. screws	Nm	kg/100 ca.	Order-No.	Designation
48,3 x 3,2	1 1/2"	63	39	66	17	35.7	69.9	94	83	M 12 x 80	85	168.0	0518612000	Z-TTO-LP48,3x3,2-3S11/2-M12
48,3 x 4	1 1/2"	63	36.5	66	17	35.7	69.9	94	83	M 12 x 80	85	173.0	0518632000	Z-TTO-LP48,3x4-3S11/2-M12
60,3 x 3,6	2"	72	49	81	27	42.9	77.8	102	97	M 12 x 100	85	222.0	0518812000	Z-TTO-LP60,3x3,6-3S2-M12
60,3 x 3,6	2 1/2"	85	49	81	27	50.8	88.9	114	109	M 12 x 100	85	323.0	0518652000	Z-TTO-LP60,3x3,6-3S21/2-M12
60,3 x 4,5	2 1/2"	85	47.5	81	27	50.8	88.9	114	109	M 12 x 100	85	302.0	0518672000	Z-TTO-LP60,3x4,5-3S21/2-M12
76,1 x 3,6	3"	100	65.5	96	28	61.9	106.4	135	131	M 16 x 110	210	530.0	0518692000	Z-TTO-LP76,1x3,6-3S3-M16
76,1 x 4,5	3"	100	63.5	96	28	61.9	106.4	135	131	M 16 x 110	210	446.0	0518712000	Z-TTO-LP76,1x4,5-3S3-M16
88,9 x 3,6	3 1/2"	114	78	108	36	69.9	120.7	152	140	M 16 x 130	210	682.0	0518732000	Z-TTO-LP88,9x3,6-3S31/2-M16
88,9 x 5	3 1/2"	114	74.5	108	36	69.9	120.7	152	140	M 16 x 130	210	693.0	0518752000	Z-TTO-LP88,9x5-3S31/2-M16
114,3 x 3,6	4"	130	102	120	36	77.8	130.2	162	152	M 16 x 140	210	844.2	0518942000	Z-TTO-LP114,3x3,6-3S4-M16
114,3 x 6,3	4"	130	96	120	36	77.8	130.2	162	152	M 16 x 140	210	870.1	0518962000	Z-TTO-LP114,3x6,3-3S4-M16

Nm = recommended tightening
torques (Nm max.) for
cylindrical bolts as spec. in DIN 912
(8.8) for friction coefficient μ tot. 0.14.

Tube connection flange couplings ZAKO LP system

Hole pattern according to SAE J 518 C / ISO 6162-1

Standard O-ring material is NBR

Permitted operating pressure (PB) 60 bar

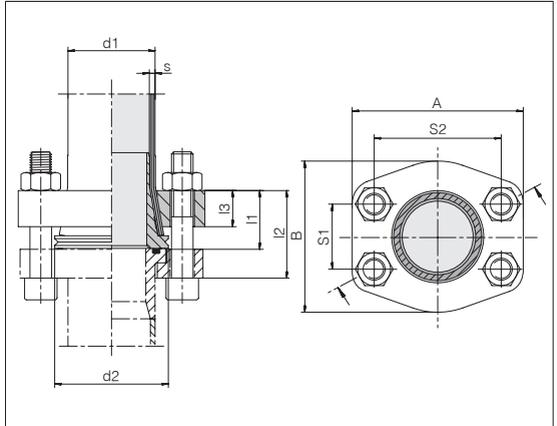

Tube d1 x s	NW	d2	l1 ap- pro x.	l2 ca.	l3	S1	S2	A	B	4 x cyl. screws	Nm	kg/100 ca.	Order-No.	Designation
48,3 x 3,2	1 1/2"	63	31.5	47.5	20	35.7	69.9	94	83	M12 x 70	85	86.0	0518822000	Z-PT-LP48,3x3,2-3S11/2-M12
48,3 x 4	1 1/2"	63	31.5	47.5	20	35.7	69.9	94	83	M12 x 70	85	88.0	0518832000	Z-PT-LP48,3x4-3S11/2-M12
60,3 x 3,6	2 1/2"	85	39	58	20.5	50.8	88.9	114	109	M12 x 80	85	161.0	0518852000	Z-PT-LP60,3x3,6-3S21/2-M12
60,3 x 3,6	2"	72	39	55	20.5	42.9	77.8	102	97	M12 x 80	85	113.0	0518842000	Z-PT-LP60,3x3,6-3S2-M12
60,3 x 4,5	2 1/2"	85	39	58	20.5	50.8	88.9	114	109	M12 x 80	85	152.0	0518862000	Z-PT-LP60,3x4,5-3S21/2-M12
76,1 x 3,6	3"	100	46	68	27	61.9	106.4	135	131	M16 x 90	210	268.0	0518872000	Z-PT-LP76,1x3,6-3S3-M16
76,1 x 4,5	3"	100	46	68	27	61.9	106.4	135	131	M16 x 90	210	229.0	0518882000	Z-PT-LP76,1x4,5-3S3-M16
88,9 x 3,6	3 1/2"	114	52	74	27.5	69.9	120.7	152	140	M16 x 110	210	341.0	0518892000	Z-PT-LP88,9x3,6-3S31/2-M16
88,9 x 5	3 1/2"	114	52	74	27.5	69.9	120.7	152	140	M16 x 110	210	347.0	0518902000	Z-PT-LP88,9x5-3S31/2-M16
114,3 x 3,6	4"	130	58	83	30	77.8	130.2	152	162	M16 x 140	210		0518972000	Z-PT-LP114,3x3,6-3S4-M16
114,3 x 6,3	4"	130	58	83	30	77.8	130.2	152	162	M16 x 140	210		0518982000	Z-PT-LP114,3x6,3-3S4-M16

Nm = recommended tightening torques (Nm max.) for cylindrical bolts as spec. in DIN 912 (8.8) for friction coefficient μ tot. 0.14.



Tube connection component ZAKO LP system

Hole pattern according to
SAE J 518 C / ISO 6162-1

90° elbow

Standard O-ring material is NBR

Permitted operating pressure (PB)
60 bar

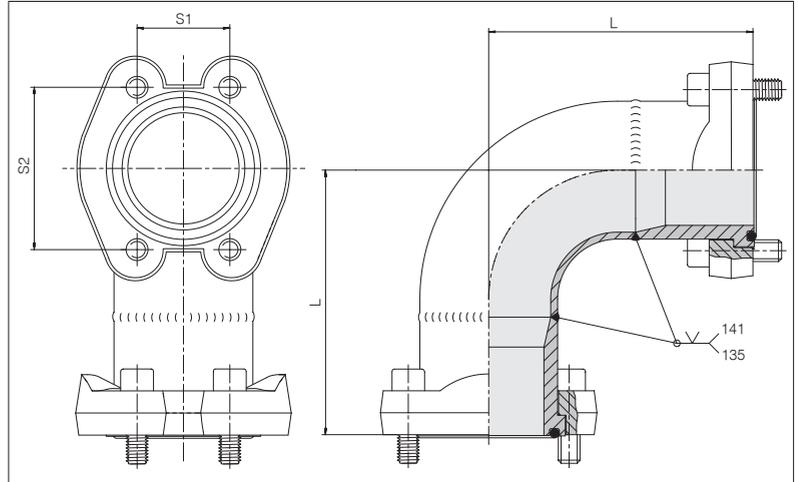

NW	L	S1	S2	4 x cyl. screws	O-ring	Nm	Order-No.	Designation
1 1/2"	104	35.7	69.9	M 12 x 35	47,22 x 3,53	85	500582000	Z-TTEO-LP-3S11/2-M12
2"	123	42.9	77.8	M 12 x 35	56,74 x 3,53	85	500602000	Z-TTEO-LP-3S2-M12-C24
2 1/2"	146	50.8	88.9	M 12 x 40	69,44 x 3,53	85	500622000	Z-TTEO-LP-3S21/2-M12
3"	161	61.9	106.4	M 16 x 45	85,32 x 3,53	210	500642000	Z-TTEO-LP-3S3-M16-C24
3 1/2"	186	69.9	120.7	M 16 x 45	98,02 x 3,53	210	500662000	Z-TTEO-LP-3S31/2-M16
4"	207.5	77.77	130.18	M 16 x 50	110,72 x 3,53	210	500702000	Z-TTEO-LP-3S4-M16

Nm = recommended tightening
torques (Nm max.) for
cylindrical bolts as spec. in DIN 912
(8.8) for friction coefficient μ tot. 0.14.

Tube connection component ZAKO LP system

Hole pattern according to SAE J 518 C / ISO 6162-1

T-coupling

Standard O-ring material is NBR

Permitted operating pressure (PB) 60 bar

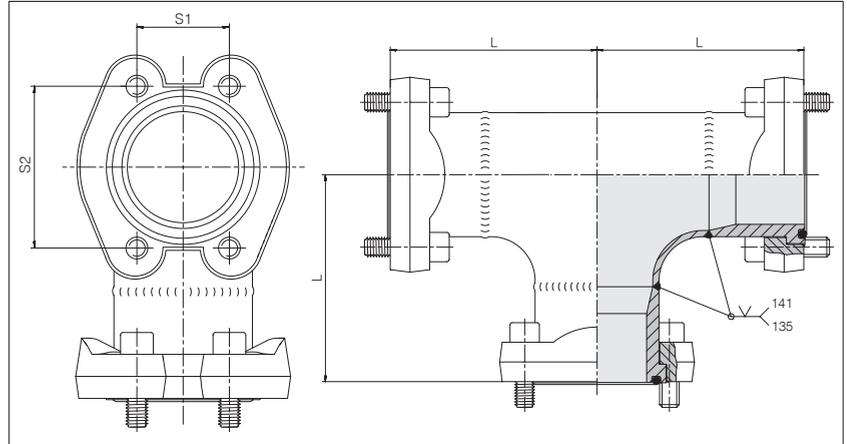

NW	L	S1	S2	4 x cyl. screws	O-ring	Nm	Order-No.	Designation
1 1/2"	102	35.7	69.9	M 12 x 35	47,22 x 3,53	85	500592000	Z-TTTO-LP-3S11/2-M12
2"	111	42.9	77.8	M 12 x 35	56,74 x 3,53	85	500612000	Z-TTTO-LP-3S2-M12-C24
2 1/2"	127	50.8	88.9	M 12 x 40	69,44 x 3,53	85	500632000	Z-TTTO-LP-3S21/2-M12
3"	130	61.9	106.4	M 16 x 45	85,32 x 3,53	210	500652000	Z-TTTO-LP-3S3-M16-C24
3 1/2"	152	69.9	120.7	M 16 x 45	98,02 x 3,53	210	500672000	Z-TTTO-LP-3S31/2-M16
4"	207.5	77.77	130.18	M 16 x 50	110,72 x 3,53	210	500712000	Z-TTTO-LP-3S4-M16

Nm = recommended tightening torques (Nm max.) for cylindrical bolts as spec. in DIN 912 (8.8) for friction coefficient μ tot. 0.14.

ZAKO ring with O-ring ZAKO LP system

O-ring is supplied in package, but not installed

Standard O-ring material is NBR

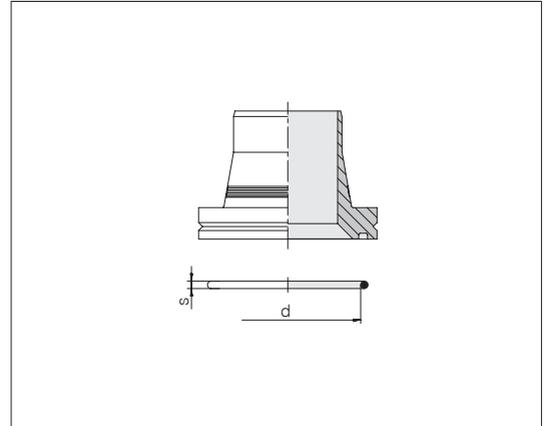

Tube d1 x s	NW	O-ring d x s	Order-No.	Designation
48,3 x 3,2	1 1/2"	47.22 x 3.53	0517102067	Z-RGO-LP48,3x3,2
48,3 x 4	1 1/2"	47.22 x 3.53	0517002067	Z-RGO-LP48,3x4
60,3 x 3,6	2"	56.74 x 3.53	0517202067	Z-RGO-LP60,3x3,6
60,3 x 3,6	2 1/2"	69.44 x 3.53	0517122067	Z-RGO-LP60,3x3,6-HD85
60,3 x 4,5	2 1/2"	69.44 x 3.53	0517022067	Z-RGO-LP60,3x4,5
76,1 x 3,6	3"	85.32 x 3.53	0517142067	Z-RGO-LP76,1x3,6
76,1 x 4,5	3"	85.32 x 3.53	0517042067	Z-RGO-LP76,1x4,5
88,9 x 3,6	3 1/2"	98.02 x 3.53	0517162067	Z-RGO-LP88,9x3,6
88,9 x 5	3 1/2"	98.02 x 3.53	0517062067	Z-RGO-LP88,9x5
114,3 x 3,6	4"	110.72 x 3.53	0517242067	Z-RGO-LP114,3x3,6
114,3 x 6,3	4"	110.72 x 3.53	0517222067	Z-RGO-LP114,3x6,3

ZAKO ring
ZAKO LP system

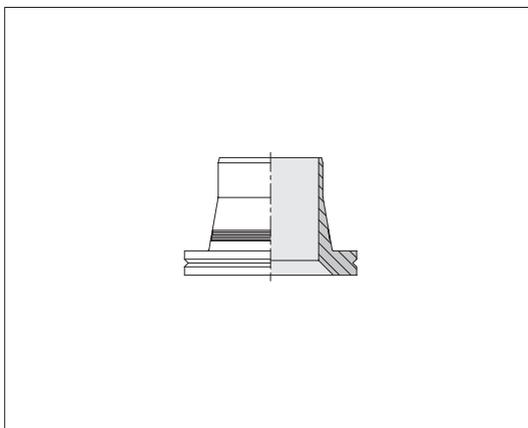

Tube d1 x s	NW	Order-No.	Designation
48,3 x 3,2	1 1/2"	0517112000	Z-R-LP48,3x3,2
48,3 x 4	1 1/2"	0517012000	Z-R-LP48,3x4
60,3 x 3,6	2"	0517212000	Z-R-LP60,3x3,6
60,3 x 3,6	2 1/2"	0517132000	Z-R-LP60,3x3,6-HD85
60,3 x 4,5	2 1/2"	0517032000	Z-R-LP60,3x4,5
76,1 x 3,6	3"	0517152000	Z-R-LP76,1x3,6
76,1 x 4,5	3"	0517052000	Z-R-LP76,1x4,5
88,9 x 3,6	3 1/2"	0517172000	Z-R-LP88,9x3,6
88,9 x 5	3 1/2"	0517072000	Z-R-LP88,9x5
114,3 x 3,6	4"	0517252000	Z-R-LP114,3x3,6
114,3 x 6,3	4"	0517232000	Z-R-LP114,3x6,3

SAE flange ZAKO LP system

Hole pattern according to SAE J 518 C / ISO 6162-1

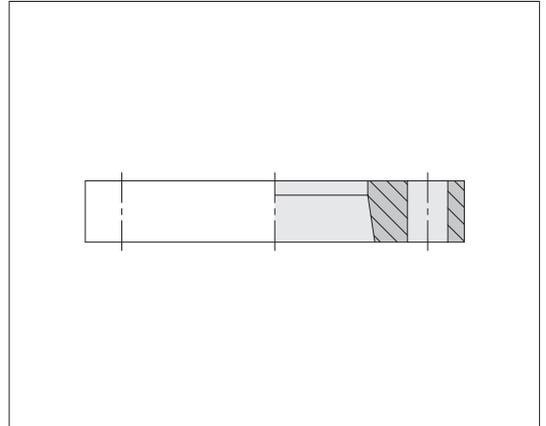

Tube OD	NW	Order-No.	Designation
48.3	1 1/2"	0518102000	Z-FPH-LP48,3-3S11/2-D13,5
60.3	2"	0518152000	Z-FPH-LP60,3-3S2-D13,5
60.3	2 1/2"	0518112000	Z-FPH-LP60,3-3S21/2-D13,5
76.1	3"	0518122000	Z-FPH-LP76,1-3S3-D17,5
88.9	3 1/2"	0518132000	Z-FPH-LP88,9-3S31/2-D17,5
114.3	4"	0518162000	Z-FPH-LP114,3-3S4-D17,5

Hydraulic valves

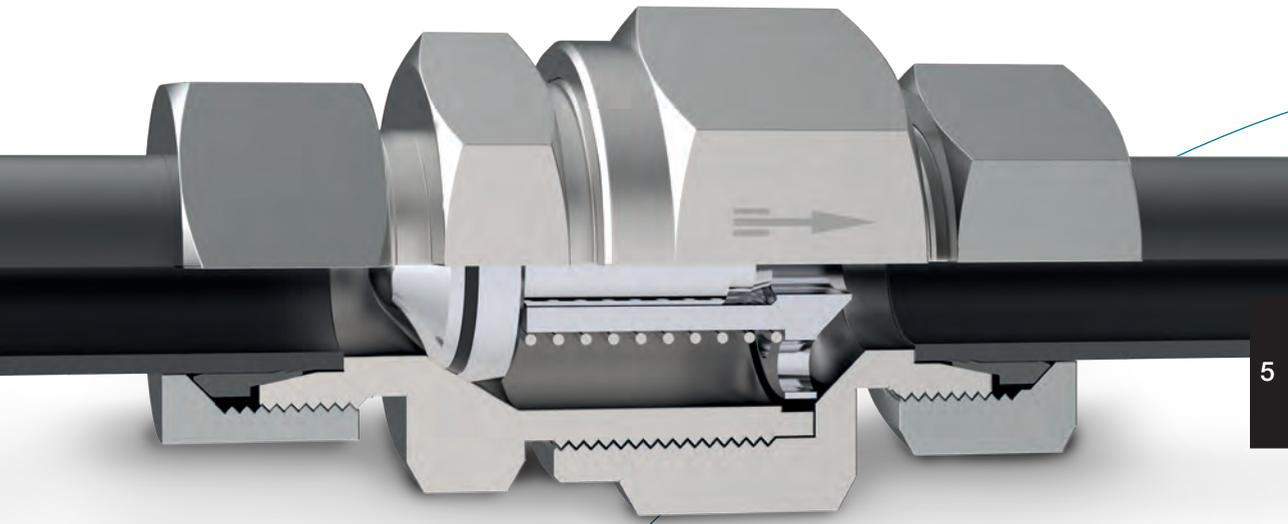

Content	Type/Page			
The new product designations of VOSS products	P.302			
Product information hydraulic valves	P.306			
Function description non-return valves	P.307			
Function description non-return valve cartridge inserts	P.309			
Function description internal valve part installation kits	P.310			
Function description shuttle valves	P.311			
Standard non-return valves	VNRO	VNROI	VNROPT	VNROTP
				
	P.313	P.314	P.316	P.318

Content	Type/Page
High-pressure non-return valves	VNROHP VNROPTHP VNROTPHP
	  
	P.320 P.321 P.323
Non-return valve plug-in cartridges	VNRCO
	
	P.325
Internal valve part installation kits	VNRIO
	
	P.326
Shuttle valves with ball seat	VST
	
	P.327
Shuttle valves with soft seals	VSOT
	
	P.329

The new designations of VOSS products



This catalog contains a new, alphanumerical product designation system based to a large extent on ISO 8434-1. This makes the designation self-explanatory and facilitates identification of the products. Since the structure is based on English, the designation is understood internationally.

Furthermore, the new product designations make it possible to generate customized special solutions by combining variations of the existing VOSS product program.

	24	- VNROTP		C	- S
System					
24° DIN program					
The "system" characteristic describes the product line.					
Function/Component					
Non-return-valves with O-Ring, tube-to-port					
The "Function/component" describes the product type.					
Form					
Completion					
Complete connection (with tube connecting system)					
This characteristic identifies the components (e. g. hexagonal nut, union nut and cutting ring, O-ring ...) that can be used to complete the product type. Complete couplings are supplied with VOSS <i>Ring</i> ^M cutting rings by default, other connection systems are listed in the "Suffix" characteristics.					
Series/Thread					
Heavy series					
Determines the series					

Non-return valve with O-ring, direction of flow towards threaded stud, fully assembled with nut and ES-4 cutting ring, AD S16 tube, G1/2 inch thread with "PEFLEX" profile ring seal, special 3 bar opening pressure





Examples of how to order items, as well as additional explanations and variation options are given in the respective chapters and in the following pages for the individual product groups.

16	G	1/2	E	3B	ES4	
						Suffix 5
						ES-4 cutting ring
						Deviations from the default characteristics (e. g. seal materials, completion using different cutting ring systems, flared coupling parts, special dimensions, special opening pressures ...)
						Suffix 3
						3 bar
						Deviations from the default characteristics (e. g. seal materials, completion using different cutting ring systems, flared coupling parts, special dimensions, special opening pressures ...)
						Sealing type/Threaded bore
						Elastomeric sealing
						Type of seal for the connecting thread.
						Diameter
						1/2 inch
						States the nominal thread size (pitch is not stated for metric and imperial thread sizes).
						Thread
						Whitworth
						Identifies the type of thread.
						Tube OD/Diameter
						OD 16 mm
						States the outer diameter of the tube.

5

System

24	24° DIN program
GP	General program (components and accessories, applicable in different connecting systems)

Function

VNRCO	Non-return valves cartridges with O-ring
VNRIO	Non-return valves inner parts with O-ring
VNRO	Non-return valves with O-ring
VNROHP	Non-return valves with O-ring, high-pressure
VNROI	Non-return valves with internal thread
VNROPT	Non-return valves with O-ring, port-to-tube,
VNROPTHP	Non-return valves with O-ring, port-to-tube, high-pressure
VNROTP	Non-return valves with O-ring, tube-to-port
VNROTPHP	Non-return valves with O-ring, tube-to-port, high-pressure
VS	Shuttle valves
VSO	Shuttle valves with O-ring
VSSWO	Shuttle valves swivel with O-ring

Form

T	Tee
---	-----

Completion

C	Complete connection (with tube connecting system)
---	---

Series/Thread

Series

L	Light series
S	Heavy series
L/S	Light and heavy series are identical

Thread

M	Metric
G	Whitworth parallel
IG	Internal thread, Whitworth parallel
IU	Internal thread, UNF

Tube OD/Diameter

6	6 mm
---	------



Tube OD/Diameter

6	6 mm
8	8 mm
10	10 mm
12	12 mm
14	14 mm
15	15 mm
16	16 mm
18	18 mm
20	20 mm
22	22 mm
25	25 mm
28	28 mm
30	30 mm
35	35 mm
38	38 mm
42	42 mm

Sealing type/Threaded bore

E	Elastomeric sealing
F	O-ring sealing

Suffix overview

Suffix 3	Opening pressure
Suffix 5	Completion
Suffix 6	Differing dimension

Suffixes not referred to here are not relevant to this chapter.

Note: For articles having more than one relevant suffix, these are listed in numerical order in the sales designation.

Suffix 3	Opening pressure
0.2B	0.2 bar
0.5B	0.5 bar
3B	3 bar
...	...

Suffix 5	Completion
1S	1S Cutting ring
ES4	ES-4 Cutting ring
BV10	BV-10 Set
24/37	24/37° Set

Suffix 6	Differing dimension
P	Profile material

Product information hydraulic valves



Non-return valves

VOSS hydraulic valves for simple function processes in hydraulic control circuits are a logical addition to our wide range of tube couplings.

- Non-return valves for in-line and block installation;
- Intelligent couplings with throttle functions
- Shuttle valves with ball seats and soft seals
- Special valves

The valves described in the following section provide an overview of the common valve types and sizes held on stock for your convenience.

We are only too happy to advise you on modifications, additional functional details or special customer-specific development work.



Shuttle valves

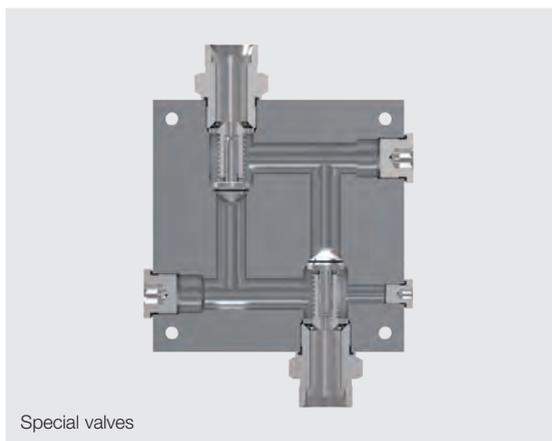

Special valves

Function description non-return valves

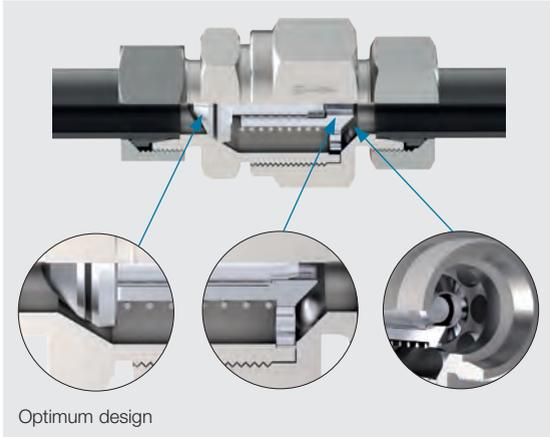

VOSS non-return valves are available in the following design variants:

- Line non-return valves with tube coupling at both ends
- Screw-in non-return valves with metric fine thread or Whitworth pipe thread and sealed with profile seals
- High-pressure non-return valves
- Non-return valve cartridge inserts
- Internal valve part installation kits

Non-return valves are also used as suction valves or pre-loading valves, depending on the opening pressure

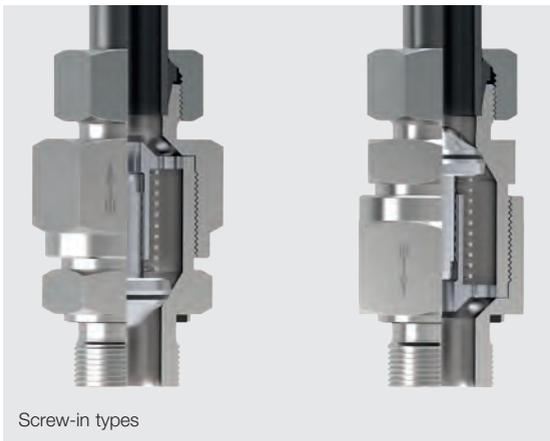

- Sealing is effected by a spring-loaded cone with an integrated soft seal
- Stroke limitation and damping pin on the seal cone reduce wear
- Flow direction from or to the threaded end of screw-in non-return valves
- Specially low flow resistance thanks to the shape of the internal parts.

Opening pressures

- Opening pressure of standard designs is 1 bar
- For special opening pressures, see the following table on VOSS non-return valves for standard and high-pressure applications

Special opening pressures

Special opening pressures	Standard	High-pressure
0.2	X	X
0.5	X	X
1.5	X	
2	X	X
2.5	X	X
3	X	X
4	X	
4.5	X	
5	X	
6	X	

Other opening pressures upon request

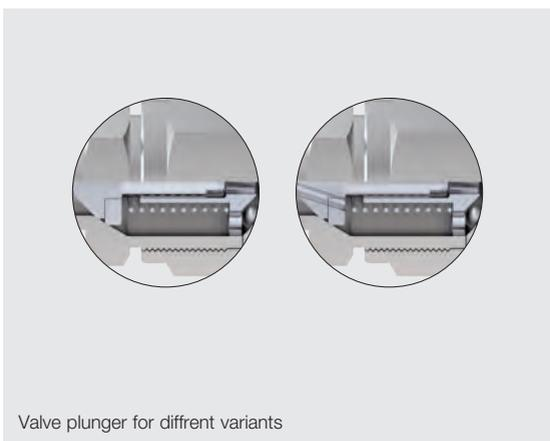

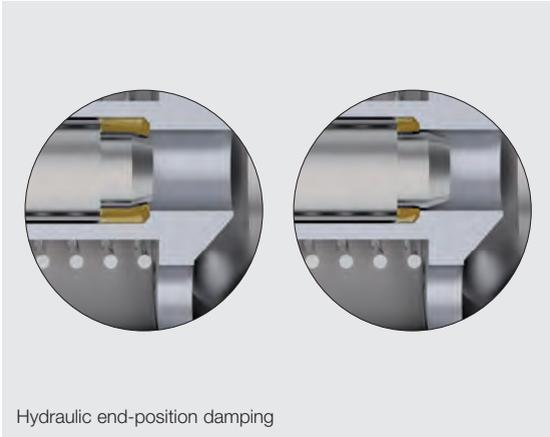

Hydraulic end-position damping

In principle, suction inlet valves with low opening pressures (e. g. 0.1 bar), or even without spring loading, can be implemented. Vertical installation with an upward flow direction is recommended for opening pressures of less than 0.5 bar in order to avoid friction effects and ensure that the disc seal is centred. However, in this case the weight of the plunger and disc affects the opening pressure.

Opening pressure tolerance: $\pm 20\%$

Valves for less than 0.2 bar:
olerances cannot be specified
(too many undefined influencing factors).

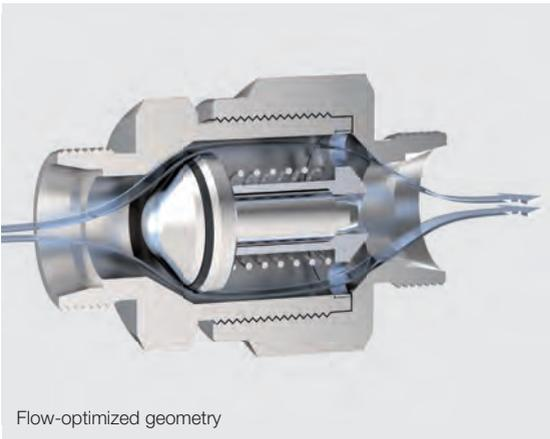

Flow-optimized geometry

Maximum opening pressure

Standard Tube OD	Max. opening pressure bar
L 6 – L 28	6
L 35	5
L 42	2
S 6 – S30	6
S 38	5

High-pressure Tube OD	Max. opening pressure bar
L 6 – L 42	3
S 6 – S 38	3

Pressure loss graphs: Non-return valves, 1 bar opening pressure, L series

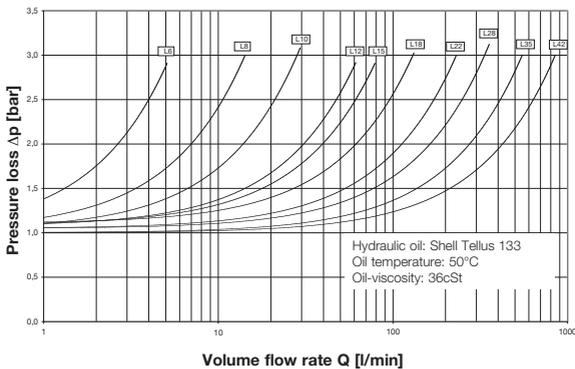

Pressure loss graphs: Non-return valves, 1 bar opening pressure, S series

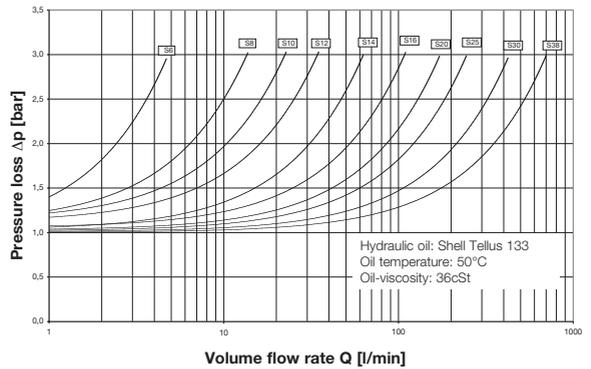

Flow resistances



Function description non-return valve cartridge inserts



As insert elements for mounting in plate structures of hydraulic devices or for direct installation in machine housings, VOSS non-return valve cartridge inserts permit flow in one direction and prevent flow in the opposite direction.

Non-return valve cartridge inserts are also used as suction valves or pre-loading valves, depending on the opening pressure.

- The compact design of VOSS non-return valve cartridge inserts makes them suitable for tight installation situations.
- Sealing is effected by a spring-loaded cone with an integrated soft seal.
- Stroke limitation and damping pin on the seal cone keep wear to a minimum.
- VOSS non-return valve cartridge inserts achieve especially low flow resistance thanks to the shape of the internal parts.
- The crosswise holes through the VOSS non-return valve cartridge inserts allow them to be used with different inflow and outlet flow directions. The valve cartridges can also be supplied without crosswise holes upon request.

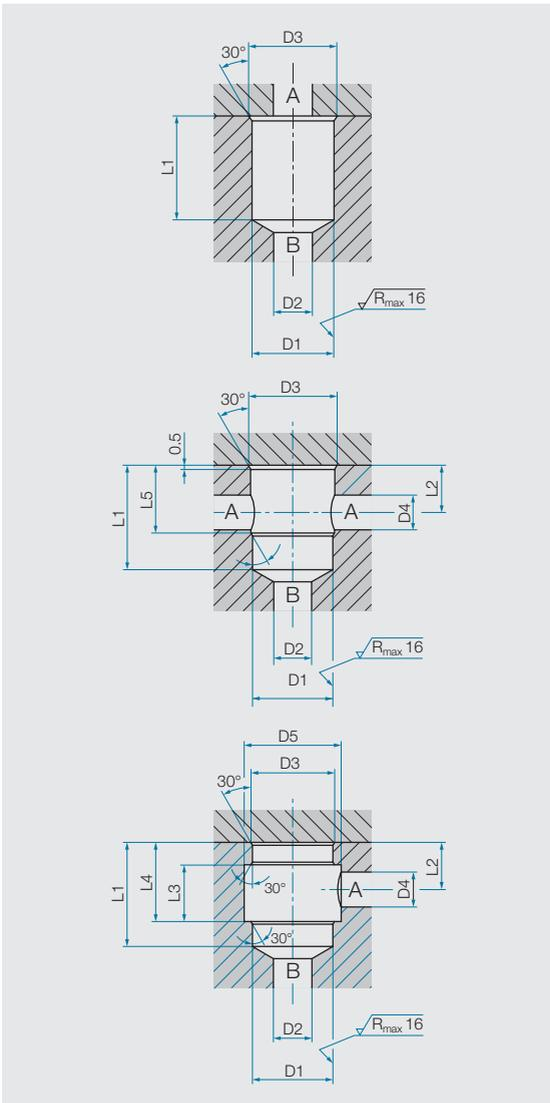

Flow resistance

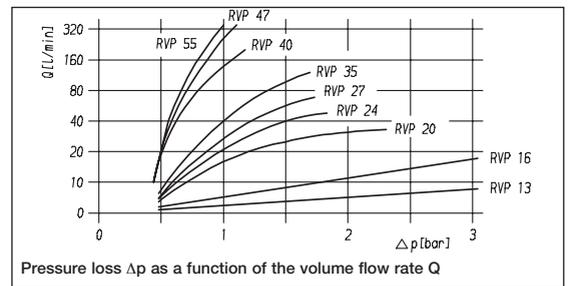

Mounting holes

Type	D1 (D10)	D2	D3 (+0.2)	D4	D5	L1 min.	L2	L3	L4	L5
RVP 13	4	13.7	4	14	23.3	12	9	15	14.5	18
RVP 16	6	16.7	6	18.5	26.8	14.5	11.5	18.5	21	20.5
RVP 20	8	20.7	8	23.5	30.3	16	14	21	23.5	26.5
RVP 24	10	25	10	27.5	35.3	18	16	24	23.5	27.5
RVP 27	12	28	12	31.5	38.3	20	19	27	26.5	27.5
RVP 35	15	36	15	40.5	44.8	19.5	23	32.5	27.5	27.5
RVP 40	19	41	19	47.5	50.8	23	27.5	38.5	33	33
RVP 47	24	48	24	56	60.3	28	35	48	40.5	40.5
RVP 55	30	56.2	30	70	70.3	28	43	56	43.5	43.5

Function description internal valve part installation kits standard

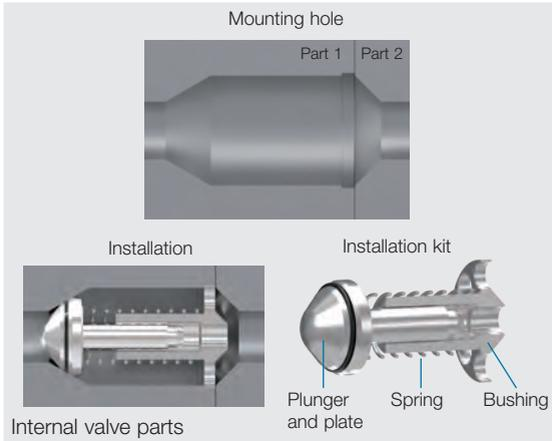

VOSS internal parts are available as kits that can be directly installed into other assemblies, such as valve blocks, manifolds and hydraulic units, which already have the specified mounting holes.

The advantages of the kits are their compact design, comprising a plunger/plate with integrated soft seal, a spring and a bushing, as well as the same low-flow resistance characteristics as the other non-return valves.

General technical data of all non-return valves standard

- Materials and surface protection: steel bodies. VOSS coat surface finish. NBR seals, other materials available upon request
- Installation orientation: any
- Operating pressure: 100 / 160 / 250 / 400 / 630 bar
- Temperature range: -35 °C to +100 °C (other temperature ranges available upon request)
- Pressure fluids: mineral-oil-based liquids (valves for other media available upon request)

Series	Tube OD	Pressure	D1 [mm]	D2 [mm]	Order no. Compl. internal parts kit (1 bar, NBR seal)
L	6	PB 250	7.5	9.3	GP-VNRIO-L/S6
L	8	PB 250	8.5	11.3	GP-VNRIO-L8
L	10	PB 250	11.7	15.3	GP-VNRIO-L10-S12
L	12	PB 250	14.8	18.8	GP-VNRIO-L12-S14
L	15	PB 250	15.8	20.8	GP-VNRIO-L15
L	18	PB 160	19.8	25.8	GP-VNRIO-L18
L	22	PB 160	24.5	31.8	GP-VNRIO-L22
L	28	PB 100	30	39.8	GP-VNRIO-L28
L	35	PB 100	38	49.8	GP-VNRIO-L35
L	42	PB 100	41	55.8	GP-VNRIO-L42
S	6	PB 630	7.5	9.3	GP-VNRIO-L/S6
S	8	PB 630	8.5	10.8	GP-VNRIO-S8
S	10	PB 630	9.6	12.8	GP-VNRIO-S10
S	12	PB 630	11.7	15.3	GP-VNRIO-L10-S12
S	14	PB 630	14.8	18.8	GP-VNRIO-L12-S14
S	16	PB 400	17	22.3	GP-VNRIO-S16
S	20	PB 400	21.7	27.8	GP-VNRIO-S20
S	25	PB 400	27	34.8	GP-VNRIO-S25
S	30	PB 250	30	40.8	GP-VNRIO-S30
S	38	PB 250	38	50.8	GP-VNRIO-S38

Identification dimensions

Function description shuttle valves

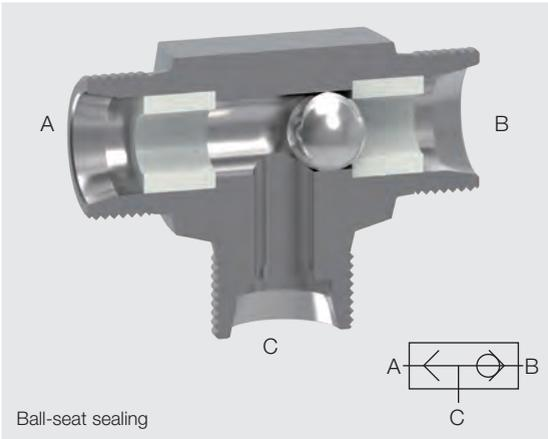

Ball seat

VOSS shuttle valves (designation “WV”) are self-actuated gate valves for closed hydraulic circuits.

With two inlet openings that can be blocked and one outlet opening, a VOSS shuttle valve will connect either port A or port B to the outlet port C, depending on the pressure applied by the hydraulic fluid feed, whereby the lower-pressure inlet is blocked by a movable ball.

This simple and sturdy valve design provides a maintenance-free solution for many applications.

The valves operate automatically

VOSS shuttle valves are part of the one-way valve product range.

- Valve type: ball-seat valve
- Available for tube in-line installation and as special designs, also with tapered seal connections
- Installation orientation: any

Materials and surface protection:
Steel valve body, VOSS coat surface protection

Pressure fluids: mineral-oil-based
(valves for other media upon request)

Temperature range: -40 °C to 120 °C
Permitted leakage: 1 cm³/min

Pressure loss Δp as a function of the volume flow rate

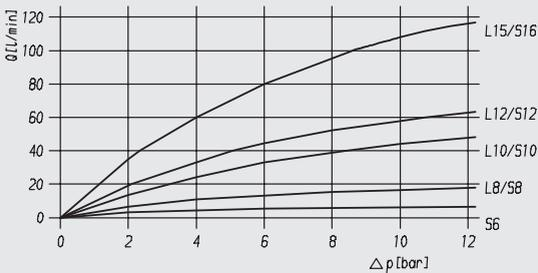

Flow resistance

Caution!

Not suitable for use with compressed air and gases and not to be used in conjunction with weld nipples!

Function description shuttle valves

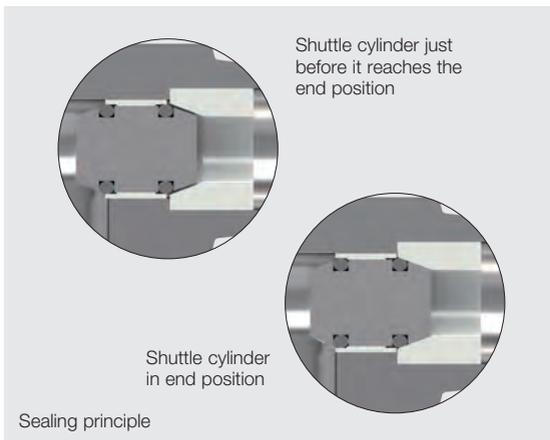
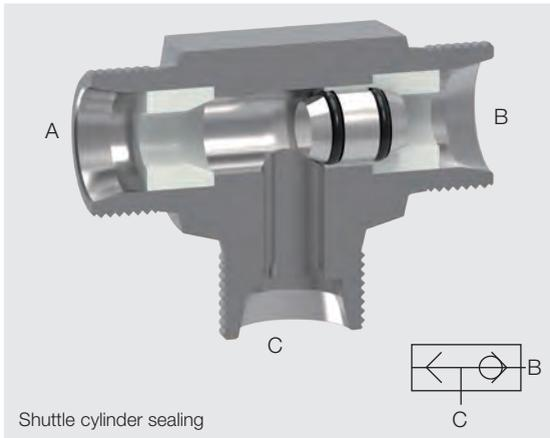

Soft sealing

In a hydraulic circuit. VOSS soft-sealing shuttle valves have the same function as ball-seat shuttle valves.

- Type: soft-sealing valve with conical seat
- For installation in-line in tubing systems (other designs available upon request).
- Installation orientation: any

Materials and surface protection:

Steel valve body. VOSS coat surface protection

Seals made of NBR (FPM/FKM seals available upon request)

Pressure fluids: mineral-oil-based

(valves for other media upon request)

Leak-tightness: absolutely leak-tight at pressures from 3 bar up (medium: hydraulic fluid)

Sealing principle:

The sliding sleeve on the shuttle cylinder

- exposes the seal area when it strikes the bushing;
- prevents the O-Ring facing the flow from being flushed out.

Temperature range:

-35 °C to +100 °C for valves with NBR seals

-25 °C to +200 °C for valves with FPM / FKM seals (available upon request)

Caution!

Not suitable for use with compressed air and gases and not for use in conjunction with weld nipples!

Standard non-return valves

Tube coupling on both ends

Opening pressure 1 bar

Standard O-ring material is NBR

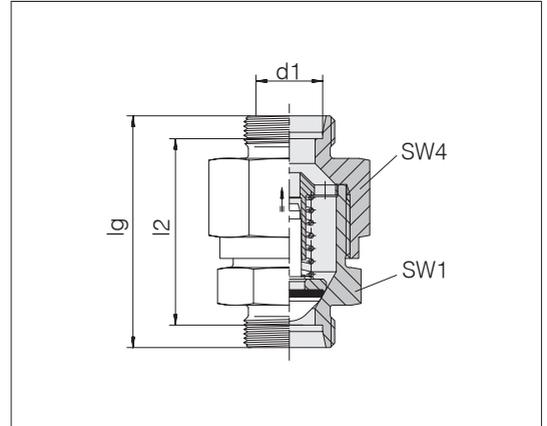

Series	Tube OD	Pressure	lg	l2	SW1	SW4	kg/100 ca.	Order-No.	Designation
L	6	PB 250	43	29	17	17	4.4	0600012081	24-VNRO-L6
L	8	PB 250	44	30	19	19	5.5	0600022081	24-VNRO-L8
L	10	PB 250	54.5	40.5	22	24	9.8	0600032081	24-VNRO-L10
L	12	PB 250	57.5	43.5	27	30	16.5	0600042081	24-VNRO-L12
L	15	PB 250	61.5	47.5	30	32	20.5	0600052081	24-VNRO-L15
L	18	PB 160	66.5	51.5	36	36	29.0	0600062081	24-VNRO-L18
L	22	PB 160	76.5	61.5	41	46	49.5	0600072081	24-VNRO-L22
L	28	PB 100	85	70	50	55	78.4	0600082081	24-VNRO-L28
L	35	PB 100	95.5	74.5	60	65	122.7	0600092081	24-VNRO-L35
L	42	PB 100	99.5	77.5	65	75	162.6	0600102081	24-VNRO-L42
S	6	PB 630	48.5	34.5	19	19	6.6	0600112081	24-VNRO-S6
S	8	PB 630	48.5	34.5	19	19	6.8	0600122081	24-VNRO-S8
S	10	PB 630	55.5	40.5	22	24	11.5	0600132081	24-VNRO-S10
S	12	PB 630	57.5	42.5	24	27	14.5	0600142081	24-VNRO-S12
S	14	PB 630	63.5	47.5	27	32	20.9	0600152081	24-VNRO-S14
S	16	PB 400	67.5	50.5	32	36	27.8	0600162081	24-VNRO-S16
S	20	PB 400	75.5	54.5	41	46	49.5	0600172081	24-VNRO-S20
S	25	PB 400	82.5	58.5	46	50	62.7	0600182081	24-VNRO-S25
S	30	PB 250	96	69	55	60	107.8	0600192081	24-VNRO-S30
S	38	PB 250	107.5	75.5	65	70	161.3	0600202081	24-VNRO-S38

Test pressure PP = 1.5 times value in table

Example for comp. : RHD06LOMD

Non-return valves

Imperial internal thread on both ends

Opening pressure 1 bar
(standard design)

Standard O-ring material is NBR

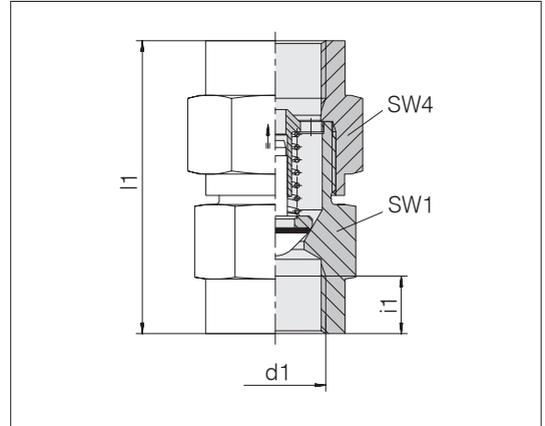

Series Tube OD	d1	Pressure	l1	SW1	SW4	i1	kg/100 ca.	Order-No.	Designation
L 6	G 1/8 A	PB 250	50.5	19	19	8	10.4	0670252000	GP-VNROI-IG1/8
L 6	G 1/4 A	PB 250	55	19	19	12	11.7	0670262000	GP-VNROI-IG1/4
L 10	G 3/8 A	PB 250	68.5	24	27	12	21.0	0670272000	GP-VNROI-IG3/8
L 15	G 1/2 A	PB 250	74	32	36	14	35.5	0670282000	GP-VNROI-IG1/2
L 18	G 3/4 A	PB 160	84	41	46	16	80.7	0670292000	GP-VNROI-IG3/4
L 22	G 1 A	PB 160	96.5	46	50	18	89.2	0670302000	GP-VNROI-IG1
L 28	G 1 1/4 A	PB 100	110	60	60	20	189.0	0670312000	GP-VNROI-IG1 1/4
L 35	G 1 1/2 A	PB 100	119	65	70	22	237.6	0670322000	GP-VNROI-IG1 1/2

Test pressure PP = 1.5 times
value in table

Example for comp. :
RHD11/8

Non-return valves

UNF internal thread according to SAE J 514 or ISO 11926-1

Opening pressure 1 bar (standard design)

Standard O-ring material is NBR

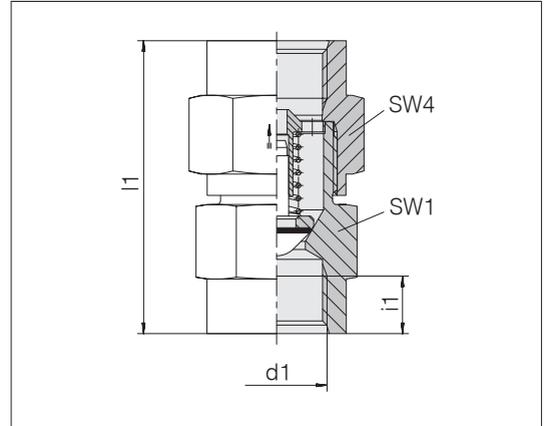

Series	d1	Pressure	l1	SW1	SW4	i1	kg/100 ca.	Order-No.	Designation
S 6	7/16-20 UNF	PB 630	57.5	19	19	11.5	11.5	0670352000	GP-VNROI-IU7/16-20F
S 8	1/2-20 UNF	PB 630	57.5	19	19	11.5	10.1	0670362000	GP-VNROI-IU1/2-20F
S 10	9/16-18 UNF	PB 630	68	22	24	12.7	17.4	0670372000	GP-VNROI-IU9/16-18F
S 12	3/4-16 UNF	PB 630	74.5	27	27	14.3	25.6	0670382000	GP-VNROI-IU3/4-16F
S 16	7/8-14 UNF	PB 400	80	32	36	16.7	44.0	0670392000	GP-VNROI-IU7/8-14F
S 20	1 1/16-12 UN	PB 400	91.5	41	46	19	79.8	0670402000	GP-VNROI-IU11/16-12F
S 25	1 5/16-12 UN	PB 400	98	46	50	19	93.0	0670412000	GP-VNROI-IU15/16-12F
S 30	1 5/8-12 UN	PB 250	104	55	60	19	153.8	0670422000	GP-VNROI-IU15/8-12F
S 38	1 7/8-12 UN	PB 250	117	65	70	19	221.4	0670442000	GP-VNROI-IU17/8-12F

Test pressure PP = 1.5 times value in table

Standard non-return valves

Flow direction from threaded stud

screw thread: metric fine thread, parallel

Sealed with PEFLEX profile seal ring

Standard seal material is NBR

Opening pressure 1 bar

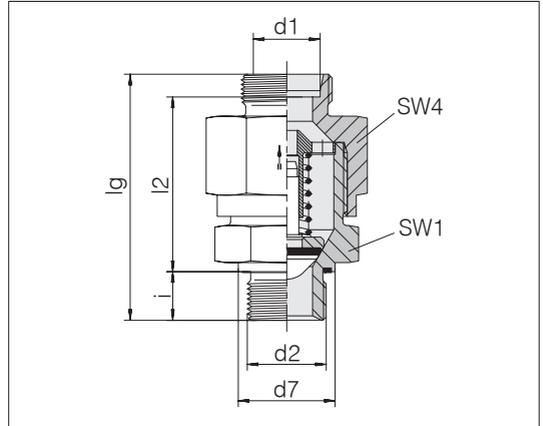

Series	d2	Pressure	d7	lg	l2	SW1	SW4	i	Nm -10 %	kg/100 ca.	Order-No.	Designation	
L	6	M 10 x 1	PB 250	13.9	44	29	17	17	8	15	4.6	0601302081	24-VNROPT-L6-M10E
L	8	M 12 x 1.5	PB 250	16.9	48	29	19	19	12	25	7.5	0601312081	24-VNROPT-L8-M12E
L	10	M 14 x 1.5	PB 250	18.9	59	40	22	24	12	50	10.6	0601322081	24-VNROPT-L10-M14E
L	12	M 16 x 1.5	PB 250	21.9	61.5	42.5	27	30	12	70	17.3	0601332081	24-VNROPT-L12-M16E
L	15	M 18 x 1.5	PB 250	23.9	64.5	45.5	30	32	12	90	20.8	0601342081	24-VNROPT-L15-M18E
L	18	M 22 x 1.5	PB 160	26.9	71.5	50	36	36	14	130	36.6	0601352081	24-VNROPT-L18-M22E
L	22	M 26 x 1.5	PB 160	31.9	81	57.5	41	46	16	180	49.9	0601362081	24-VNROPT-L22-M26E
L	28	M 33 x 2	PB 100	39.9	92	66.5	50	55	18	230	81.5	0601372081	24-VNROPT-L28-M33E
L	35	M 42 x 2	PB 100	49.9	101.5	71	60	65	20	330	124.8	0601382081	24-VNROPT-L35-M42E
L	42	M 48 x 2	PB 100	54.9	109.5	76.5	65	75	22	500	169.6	0601392081	24-VNROPT-L42-M48E
S	6	M 12 x 1.5	PB 630	16.9	50.5	31.5	19	19	12	50	9.0	0601402081	24-VNROPT-S6-M12E
S	8	M 14 x 1.5	PB 630	18.9	50.5	31.5	19	19	12	60	7.0	0601412081	24-VNROPT-S8-M14E
S	10	M 16 x 1.5	PB 630	21.9	57.5	38	22	24	12	80	15.6	0601422081	24-VNROPT-S10-M16E
S	12	M 18 x 1.5	PB 630	23.9	60.5	41	24	27	12	90	15.4	0601432081	24-VNROPT-S12-M18E
S	14	M 20 x 1.5	PB 630	25.9	66.5	44.5	27	32	14	130	27.2	0601442081	24-VNROPT-S14-M20E
S	16	M 22 x 1.5	PB 400	26.9	70.5	48	32	36	14	130	36.0	0601452081	24-VNROPT-S16-M22E
S	20	M 27 x 2	PB 400	31.9	78.5	52	41	46	16	200	50.3	0601462081	24-VNROPT-S20-M27E
S	25	M 33 x 2	PB 400	39.9	87	57	46	50	18	250	87.3	0601472081	24-VNROPT-S25-M33E
S	30	M 42 x 2	PB 250	49.9	99.5	66	55	60	20	500	113.2	0601482081	24-VNROPT-S30-M42E
S	38	M 48 x 2	PB 250	54.9	110	72	65	70	22	600	197.3	0601492081	24-VNROPT-S38-M48E

Test pressure PP = 1.5 times
value in table

Example for comp. :
RHW06LMEDOMD



Standard non-return valves

Flow direction from threaded stud

screw thread: Whitworth pipe thread, parallel

Sealed with PEFLEX profile seal ring

Standard seal material is NBR

Opening pressure 1 bar

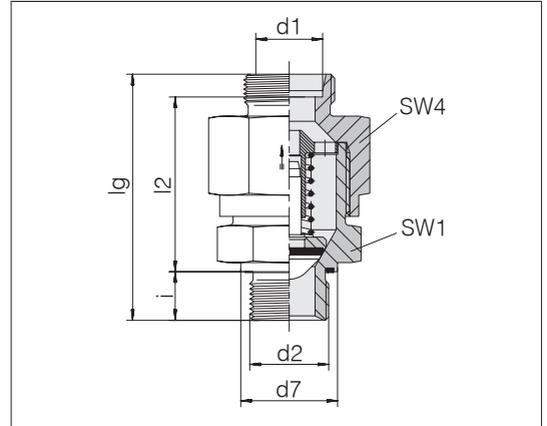

Series	d2	Pressure	d7	lg	l2	SW1	SW4	i	Nm -10 %	kg/100 ca.	Order-No.	Designation	
L	6	G 1/8 A	PB 250	13.9	44	29	17	17	8	20	5.7	0602302081	24-VNROPT-L6-G1/8E
L	8	G 1/4 A	PB 250	18.9	49	30	19	19	12	50	6.2	0602312081	24-VNROPT-L8-G1/4E
L	10	G 1/4 A	PB 250	18.9	59.5	40.5	22	24	12	50	10.6	0602322081	24-VNROPT-L10-G1/4E
L	12	G 3/8 A	PB 250	21.9	61.5	42.5	27	30	12	80	17.2	0602332081	24-VNROPT-L12-G3/8E
L	15	G 1/2 A	PB 250	26.9	66.5	45.5	30	32	14	100	21.9	0602342081	24-VNROPT-L15-G1/2E
L	18	G 1/2 A	PB 160	26.9	72.5	51	36	36	14	100	30.1	0602352081	24-VNROPT-L18-G1/2E
L	22	G 3/4 A	PB 160	31.9	80	56.5	41	46	16	180	48.8	0602362081	24-VNROPT-L22-G3/4E
L	28	G 1 A	PB 100	39.9	92	66.5	50	55	18	230	81.0	0602372081	24-VNROPT-L28-G1E
L	35	G 1 1/4 A	PB 100	49.9	102.5	72	60	65	20	330	126.6	0602382081	24-VNROPT-L35-G11/4E
L	42	G 1 1/2 A	PB 100	54.9	109.5	76.5	65	75	22	500	170.1	0602392081	24-VNROPT-L42-G11/2E
S	6	G 1/4 A	PB 630	18.9	50.5	31.5	19	19	12	60	7.0	0602402081	24-VNROPT-S6-G1/4E
S	8	G 1/4 A	PB 630	18.9	50.5	31.5	19	19	12	60	6.8	0602412081	24-VNROPT-S8-G1/4E
S	10	G 3/8 A	PB 630	21.9	57.5	38	22	24	12	90	12.0	0602422081	24-VNROPT-S10-G3/8E
S	12	G 3/8 A	PB 630	21.9	60.5	41	24	27	12	90	14.9	0602432081	24-VNROPT-S12-G3/8E
S	14	G 1/2 A	PB 630	26.9	66.5	44.5	27	32	14	150	22.2	0602442081	24-VNROPT-S14-G1/2E
S	16	G 1/2 A	PB 400	26.9	70.5	48	32	36	14	150	28.1	0602452081	24-VNROPT-S16-G1/2E
S	20	G 3/4 A	PB 400	31.9	78.5	52	41	46	16	200	50.2	0602462081	24-VNROPT-S20-G3/4E
S	25	G 1 A	PB 400	39.9	87.5	57.5	46	50	18	250	65.7	0602472081	24-VNROPT-S25-G1E
S	30	G 1 1/4 A	PB 250	49.9	97.5	64	55	60	20	500	108.2	0602482081	24-VNROPT-S30-G11/4E
S	38	G 1 1/2 A	PB 250	54.9	109.5	71.5	65	70	22	600	162.1	0602492081	24-VNROPT-S38-G11/2E

Test pressure PP = 1.5 times
value in table

Example for comp. :
RRHV06LREDOMD

Standard non-return valves

Flow direction to threaded stud

screw thread: metric fine thread, parallel

Sealed with PEFLEX profile seal ring

Standard seal material is NBR

Opening pressure 1 bar

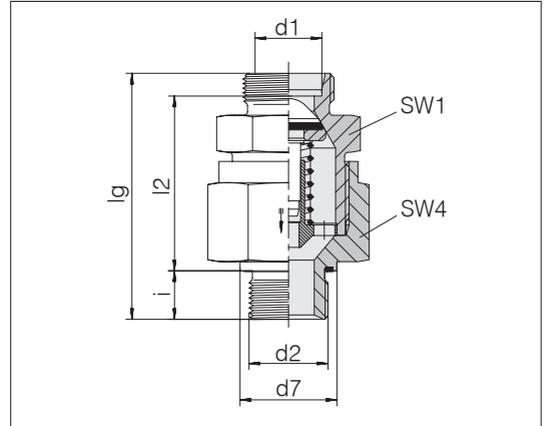

Series	d2	Pressure	d7	lg	l2	SW1	SW4	i	Nm -10 %	kg/100 ca.	Order-No.	Designation
Tube OD d1												
L 6	M 10 x 1	PB 250	13.9	43	28	17	17	8	15	5.7	0603302081	24-VNROTP-L6-M10E
L 8	M 12 x 1.5	PB 250	16.9	47.5	28.5	19	19	12	25	5.5	0603312081	24-VNROTP-L8-M12E
L 10	M 14 x 1.5	PB 250	18.9	57.5	38.5	22	24	12	50	10.3	0603322081	24-VNROTP-L10-M14E
L 12	M 16 x 1.5	PB 250	21.9	60	41	27	30	12	70	16.5	0603332081	24-VNROTP-L12-M16E
L 15	M 18 x 1.5	PB 250	23.9	63	44	30	32	12	90	19.9	0603342081	24-VNROTP-L15-M18E
L 18	M 22 x 1.5	PB 160	26.9	69.5	48	36	36	14	130	28.3	0603352081	24-VNROTP-L18-M22E
L 22	M 26 x 1.5	PB 160	31.9	79.5	56	41	46	16	180	47.9	0603362081	24-VNROTP-L22-M26E
L 28	M 33 x 2	PB 100	39.9	91	65.5	50	55	18	230	79.4	0603372081	24-VNROTP-L28-M33E
L 35	M 42 x 2	PB 100	49.9	102	71.5	60	65	20	330	125.8	0603382081	24-VNROTP-L35-M42E
L 42	M 48 x 2	PB 100	54.9	108.5	75.5	65	75	22	500	194.0	0603392081	24-VNROTP-L42-M48E
S 6	M 12 x 1.5	PB 630	16.9	50.5	31.5	19	19	12	50	9.3	0603402081	24-VNROTP-S6-M12E
S 8	M 14 x 1.5	PB 630	18.9	50.5	31.5	19	19	12	60	9.2	0603412081	24-VNROTP-S8-M14E
S 10	M 16 x 1.5	PB 630	21.9	57.5	38	22	24	12	80	11.8	0603422081	24-VNROTP-S10-M16E
S 12	M 18 x 1.5	PB 630	23.9	60.5	41	24	27	12	90	18.9	0603432081	24-VNROTP-S12-M18E
S 14	M 20 x 1.5	PB 630	25.9	65.5	43.5	27	32	14	130	27.9	0603442081	24-VNROTP-S14-M20E
S 16	M 22 x 1.5	PB 400	26.9	69	46.5	32	36	14	130	27.5	0603452081	24-VNROTP-S16-M22E
S 20	M 27 x 2	PB 400	31.9	78.5	52	41	46	16	200	50.3	0603462081	24-VNROTP-S20-M27E
S 25	M 33 x 2	PB 400	39.9	87	57	46	50	18	250	65.5	0603472081	24-VNROTP-S25-M33E
S 30	M 42 x 2	PB 250	49.9	99.5	66	55	60	20	500	133.8	0603482081	24-VNROTP-S30-M42E
S 38	M 48 x 2	PB 250	54.9	110.5	72.5	65	70	22	600	196.9	0603492081	24-VNROTP-S38-M48E

Test pressure PP = 1.5 times
value in table

Example for comp. :
RH206LMEDOMD



Standard non-return valves

Flow direction to threaded stud

screw thread: Whitworth pipe thread, parallel

Sealed with PEFLEX profile seal ring

Standard seal material is NBR

Opening pressure 1 bar

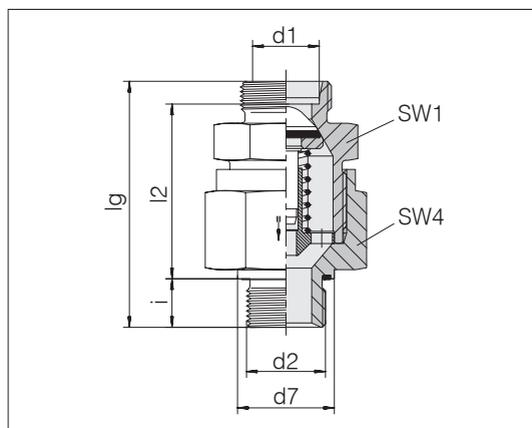

Series	d2	Pressure	d7	lg	l2	SW1	SW4	i	Nm -10 %	kg/100 ca.	Order-No.	Designation	
L	6	G 1/8 A	PB 250	13.9	43	28	17	17	8	20	4.5	0604302081	24-VNROTP-L6-G1/8E
L	8	G 1/4 A	PB 250	18.9	47.5	28.5	19	19	12	50	5.8	0604312081	24-VNROTP-L8-G1/4E
L	10	G 1/4 A	PB 250	18.9	59	40	22	24	12	50	10.6	0604322081	24-VNROTP-L10-G1/4E
L	12	G 3/8 A	PB 250	21.9	60.5	41.5	27	30	12	80	16.8	0604332081	24-VNROTP-L12-G3/8E
L	15	G 1/2 A	PB 250	26.9	65	44	30	32	14	100	20.8	0604342081	24-VNROTP-L15-G1/2E
L	18	G 1/2 A	PB 160	26.9	69.5	48	36	36	14	100	28.0	0604352081	24-VNROTP-L18-G1/2E
L	22	G 3/4 A	PB 160	31.9	80.5	57	41	46	16	180	49.4	0604362081	24-VNROTP-L22-G3/4E
L	28	G 1 A	PB 100	39.9	92.5	67	50	55	18	230	81.9	0604372081	24-VNROTP-L28-G1E
L	35	G 1 1/4 A	PB 100	49.9	102	71.5	60	65	20	330	121.7	0604382081	24-VNROTP-L35-G11/4E
L	42	G 1 1/2 A	PB 100	54.9	108.5	75.5	65	75	22	500	167.2	0604392081	24-VNROTP-L42-G11/2E
S	6	G 1/4 A	PB 630	18.9	50.5	31.5	19	19	12	60	7.0	0604402081	24-VNROTP-S6-G1/4E
S	8	G 1/4 A	PB 630	18.9	50.5	31.5	19	19	12	60	6.9	0604412081	24-VNROTP-S8-G1/4E
S	10	G 3/8 A	PB 630	21.9	57.5	38	22	24	12	90	12.0	0604422081	24-VNROTP-S10-G3/8E
S	12	G 3/8 A	PB 630	21.9	60.5	41	24	27	12	90	15.0	0604432081	24-VNROTP-S12-G3/8E
S	14	G 1/2 A	PB 630	26.9	65.5	43.5	27	32	14	150	21.6	0604442081	24-VNROTP-S14-G1/2E
S	16	G 1/2 A	PB 400	26.9	70.5	48	32	36	14	150	28.0	0604452081	24-VNROTP-S16-G1/2E
S	20	G 3/4 A	PB 400	31.9	78.5	52	41	46	16	200	50.7	0604462081	24-VNROTP-S20-G3/4E
S	25	G 1 A	PB 400	39.9	87	57	46	50	18	250	65.6	0604472081	24-VNROTP-S25-G1E
S	30	G 1 1/4 A	PB 250	49.9	99.5	66	55	60	20	500	108.5	0604482081	24-VNROTP-S30-G11/4E
S	38	G 1 1/2 A	PB 250	54.9	110.5	72.5	65	70	22	600	161.8	0604492081	24-VNROTP-S38-G11/2E

Test pressure PP = 1.5 times
value in table

Example for comp. :
RHZ06LREDDOMD

High-pressure non-return valves

Tube coupling on both ends

Opening pressure 1 bar

Standard O-ring material is NBR

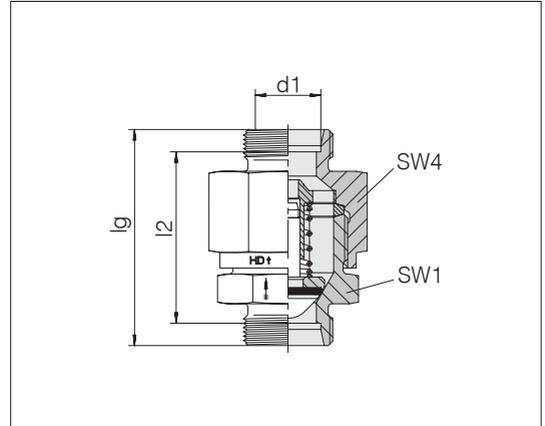

Series	Pressure	lg	l2	SW1	SW4	kg/100 ca.	Order-No.	Designation
L 6	PN 400	45.5	31.5	17	19	6.3	1600012081	24-VNROHP-L6
L 8	PN 400	49	35	19	22	8.2	1600022081	24-VNROHP-L8
L 10	PN 400	52	38	22	24	10.8	1600032081	24-VNROHP-L10
L 12	PN 400	53	39	27	30	16.3	1600042081	24-VNROHP-L12
L 15	PN 400	58	44	30	32	21.0	1600052081	24-VNROHP-L15
L 18	PN 400	63	48	36	36	31.7	1600062081	24-VNROHP-L18
L 22	PN 250	72.5	57.5	41	46	51.2	1600072081	24-VNROHP-L22
L 28	PN 250	75.5	60.5	50	55	76.4	1600082081	24-VNROHP-L28
L 35	PN 250	90	69	60	65	121.3	1600092081	24-VNROHP-L35
L 42	PN 250	88	66	65	70	134.9	1600102081	24-VNROHP-L42
S 6	PN 420	49	35	19	19	7.6	1600112081	24-VNROHP-S6
S 8	PN 420	49	35	19	19	7.8	1600122081	24-VNROHP-S8
S 10	PN 420	53	38	22	24	12.3	1600132081	24-VNROHP-S10
S 12	PN 420	55	40	24	27	15.7	1600142081	24-VNROHP-S12
S 14	PN 420	59	43	27	32	21.0	1600152081	24-VNROHP-S14
S 16	PN 420	65	48	32	36	25.1	1600162081	24-VNROHP-S16
S 20	PN 420	73	52	41	41	45.3	1600172081	24-VNROHP-S20
S 25	PN 420	78	54	46	50	71.5	1600182081	24-VNROHP-S25
S 30	PN 250	91	64	55	60	109.6	1600192081	24-VNROHP-S30
S 38	PN 250	99	67	65	70	155.5	1600202081	24-VNROHP-S38

High-pressure non-return valves

Flow direction from threaded stud

screw thread: metric fine thread, parallel

Sealed with PEFLEX profile seal ring

Standard seal material is NBR

Opening pressure 1 bar

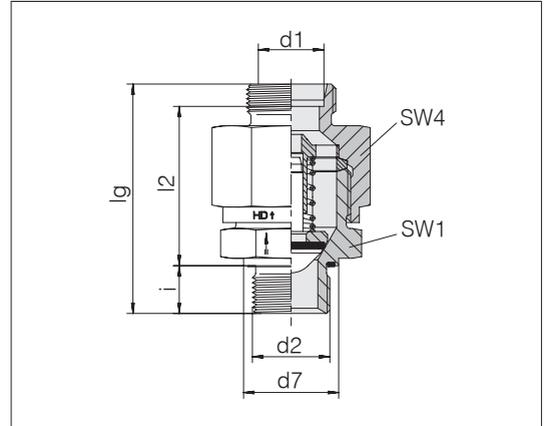

Series	d2	Pressure	d7	lg	l2	SW1	SW4	i	Nm -10 %	kg/100 ca.	Order-No.	Designation	
L	6	M 10 x 1	PN 400	13.9	45	30	17	19	8	15	6.2	1601302081	24-VNROPTHP-L6-M10E
L	8	M 12 x 1.5	PN 400	16.9	51	32	19	22	12	25	8.2	1601312081	24-VNROPTHP-L8-M12E
L	10	M 14 x 1.5	PN 400	18.9	53	34	22	24	12	50	10.7	1601322081	24-VNROPTHP-L10-M14E
L	12	M 16 x 1.5	PN 400	21.9	58	39	27	30	12	70	17.6	1601332081	24-VNROPTHP-L12-M16E
L	15	M 18 x 1.5	PN 400	23.9	60	41	30	32	12	90	20.8	1601342081	24-VNROPTHP-L15-M18E
L	18	M 22 x 1.5	PN 400	26.9	67	45.5	36	36	14	130	33.2	1601352081	24-VNROPTHP-L18-M22E
L	22	M 26 x 1.5	PN 250	31.9	77	53.5	41	46	16	180	51.9	1601362081	24-VNROPTHP-L22-M26E
L	28	M 33 x 2	PN 250	39.9	85.5	60	50	55	18	230	83.1	1601372081	24-VNROPTHP-L28-M33E
L	35	M 42 x 2	PN 250	49.9	97.5	67	60	65	20	330	126.6	1601382081	24-VNROPTHP-L35-M42E
L	42	M 48 x 2	PN 250	54.9	98.5	65.5	65	70	22	500	144.1	1601392081	24-VNROPTHP-L42-M48E
S	6	M 12 x 1.5	PN 420	16.9	51	32	19	19	12	50	7.6	1601402081	24-VNROPTHP-S6-M12E
S	8	M 14 x 1.5	PN 420	18.9	51	32	19	19	12	60	7.9	1601412081	24-VNROPTHP-S8-M14E
S	10	M 16 x 1.5	PN 420	21.9	56.5	37	22	24	12	80	12.3	1601422081	24-VNROPTHP-S10-M16E
S	12	M 18 x 1.5	PN 420	23.9	58	38.5	24	27	12	90	16.4	1601432081	24-VNROPTHP-S12-M18E
S	16	M 22 x 1.5	PN 420	26.9	67	44.5	32	36	14	130	29.3	1601452081	24-VNROPTHP-S16-M22E
S	20	M 27 x 2	PN 420	31.9	77	50.5	41	41	16	200	46.9	1601462081	24-VNROPTHP-S20-M27E
S	25	M 33 x 2	PN 420	39.9	84.5	54.5	46	50	18	250	74.2	1601472081	24-VNROPTHP-S25-M33E
S	30	M 42 x 2	PN 250	49.9	94	60.5	55	60	20	500	114.9	1601482081	24-VNROPTHP-S30-M42E
S	38	M 48 x 2	PN 250	54.9	103.5	65.5	65	70	22	600	161.0	1601492081	24-VNROPTHP-S38-M48E

High-pressure non-return valves

Flow direction from threaded stud

screw thread: Whitworth pipe thread, parallel

Sealed with PEFLEX profile seal ring

Standard seal material is NBR

Opening pressure 1 bar

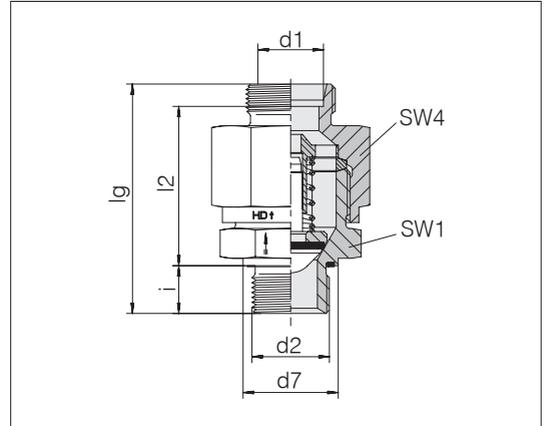

Series	d2	Pressure	d7	lg	l2	SW1	SW4	i	Nm -10 %	kg/100 ca.	Order-No.	Designation
Tube OD d1												
L 6	G 1/8 A	PN 400	13.9	45	30	17	19	8	20	6.2	1602302081	24-VNROPTHP-L6-G1/8E
L 8	G 1/4 A	PN 400	18.9	51	32	19	22	12	50	8.5	1602312081	24-VNROPTHP-L8-G1/4E
L 10	G 1/4 A	PN 400	18.9	53	34	22	24	12	50	10.4	1602322081	24-VNROPTHP-L10-G1/4E
L 12	G 3/8 A	PN 400	21.9	58	39	27	30	12	80	17.2	1602332081	24-VNROPTHP-L12-G3/8E
L 15	G 1/2 A	PN 400	26.9	62	41	30	32	14	100	22.1	1602342081	24-VNROPTHP-L15-G1/2E
L 18	G 1/2 A	PN 400	26.9	67	45.5	36	36	14	100	29.4	1602352081	24-VNROPTHP-L18-G1/2E
L 22	G 3/4 A	PN 250	31.9	77	53.5	41	46	16	180	51.9	1602362081	24-VNROPTHP-L22-G3/4E
L 28	G 1 A	PN 250	39.9	85.5	60	50	55	18	230	83.3	1602372081	24-VNROPTHP-L28-G1E
L 35	G 1 1/4 A	PN 250	49.9	97.5	67	60	65	20	330	126.3	1602382081	24-VNROPTHP-L35-G11/4E
L 42	G 1 1/2 A	PN 250	54.9	98.5	65.5	65	70	22	500	143.5	1602392081	24-VNROPTHP-L42-G11/2E
S 6	G 1/4 A	PN 420	18.9	51	32	19	19	12	60	7.8	1602402081	24-VNROPTHP-S6-G1/4E
S 8	G 1/4 A	PN 420	18.9	51	32	19	19	12	60	7.7	1602412081	24-VNROPTHP-S8-G1/4E
S 10	G 3/8 A	PN 420	21.9	56.5	37	22	24	12	90	13.1	1602422081	24-VNROPTHP-S10-G3/8E
S 12	G 3/8 A	PN 420	21.9	58	38.5	24	27	12	90	15.9	1602432081	24-VNROPTHP-S12-G3/8E
S 16	G 1/2 A	PN 420	26.9	67	44.5	32	36	14	150	28.9	1602452081	24-VNROPTHP-S16-G1/2E
S 20	G 3/4 A	PN 420	31.9	77	50.5	41	41	16	200	46.6	1602462081	24-VNROPTHP-S20-G3/4E
S 25	G 1 A	PN 420	39.9	84.5	54.5	46	50	18	250	74.4	1602472081	24-VNROPTHP-S25-G1E
S 30	G 1 1/4 A	PN 250	49.9	94	60.5	55	60	20	500	114.7	1602482081	24-VNROPTHP-S30-G11/4E
S 38	G 1 1/2 A	PN 250	54.9	103.5	65.5	65	70	22	600	160.5	1602492081	24-VNROPTHP-S38-G11/2E

High-pressure non-return valves

Flow direction to threaded stud

screw thread: metric fine thread, parallel

Sealed with PEFLEX profile seal ring

Standard seal material is NBR

Opening pressure 1 bar

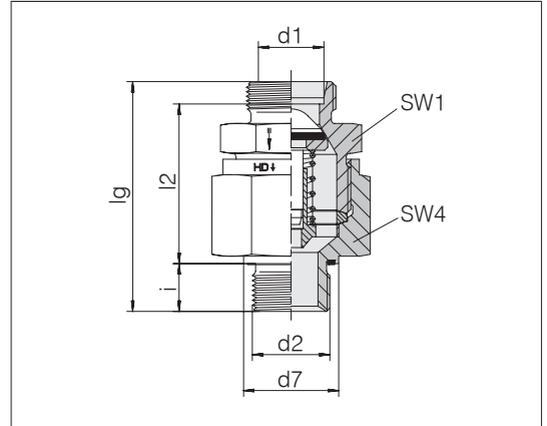

Series	d2	Pressure	d7	lg	l2	SW1	SW4	i	Nm -10 %	kg/100 ca.	Order-No.	Designation	
L	6	M 10 x 1	PN 400	13.9	44	29	17	19	8	15	6.0	1603302081	24-VNROTPHP-L6-M10E
L	8	M 12 x 1.5	PN 400	16.9	51	32	19	22	12	25	8.2	1603312081	24-VNROTPHP-L8-M12E
L	10	M 14 x 1.5	PN 400	18.9	53	34	22	24	12	50	10.6	1603322081	24-VNROTPHP-L10-M14E
L	12	M 16 x 1.5	PN 400	21.9	58	39	27	30	12	70	17.8	1603332081	24-VNROTPHP-L12-M16E
L	15	M 18 x 1.5	PN 400	23.9	60	41	30	32	12	90	20.8	1603342081	24-VNROTPHP-L15-M18E
L	18	M 22 x 1.5	PN 400	26.9	67	45.5	36	36	14	130	29.5	1603352081	24-VNROTPHP-L18-M22E
L	22	M 26 x 1.5	PN 250	31.9	77	53.5	41	46	16	180	51.4	1603362081	24-VNROTPHP-L22-M26E
L	28	M 33 x 2	PN 250	39.9	80	54.5	50	55	18	230	74.7	1603372081	24-VNROTPHP-L28-M33E
L	35	M 42 x 2	PN 250	49.9	97.5	67	60	65	20	330	126.8	1603382081	24-VNROTPHP-L35-M42E
L	42	M 48 x 2	PN 250	54.9	98	65	65	70	22	500	143.5	1603392081	24-VNROTPHP-L42-M48E
S	6	M 12 x 1.5	PN 420	16.9	51	32	19	19	12	50	7.6	1603402081	24-VNROTPHP-S6-M12E
S	8	M 14 x 1.5	PN 420	18.9	51	32	19	19	12	60	7.9	1603412081	24-VNROTPHP-S8-M14E
S	10	M 16 x 1.5	PN 420	21.9	56.5	37	22	24	12	80	13.1	1603422081	24-VNROTPHP-S10-M16E
S	12	M 18 x 1.5	PN 420	23.9	56.5	37	24	27	12	90	15.7	1603432081	24-VNROTPHP-S12-M18E
S	16	M 22 x 1.5	PN 420	26.9	67	44.5	32	36	14	130	29.5	1603452081	24-VNROTPHP-S16-M22E
S	20	M 27 x 2	PN 420	31.9	77	50.5	41	41	16	200	46.9	1603462081	24-VNROTPHP-S20-M27E
S	25	M 33 x 2	PN 420	39.9	82.5	52.5	46	50	18	250	71.3	1603472081	24-VNROTPHP-S25-M33E
S	30	M 42 x 2	PN 250	49.9	94	60.5	55	60	20	500	114.9	1603482081	24-VNROTPHP-S30-M42E
S	38	M 48 x 2	PN 250	54.9	103.5	65.5	65	70	22	600	162.9	1603492081	24-VNROTPHP-S38-M48E

High-pressure non-return valves

Flow direction to threaded stud

screw thread: Whitworth pipe thread, parallel

Sealed with PEFLEX profile seal ring

Standard seal material is NBR

Opening pressure 1 bar

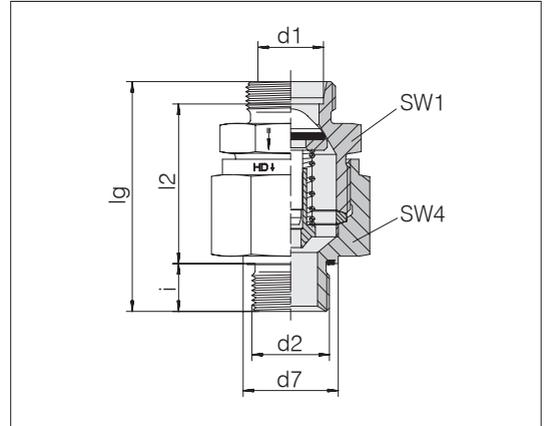

Series	d2	Pressure	d7	lg	l2	SW1	SW4	i	Nm -10 %	kg/100 ca.	Order-No.	Designation
Tube OD d1												
L 6	G 1/8 A	PN 400	13.9	44	29	17	17	8	20	6.0	1604302081	24-VNROTPHP-L6-G1/8E
L 8	G 1/4 A	PN 400	18.9	51	32	19	19	12	50	8.5	1604312081	24-VNROTPHP-L8-G1/4E
L 10	G 1/4 A	PN 400	18.9	53	34	22	24	12	50	10.4	1604322081	24-VNROTPHP-L10-G1/4E
L 12	G 3/8 A	PN 400	21.9	58	39	27	30	12	80	17.8	1604332081	24-VNROTPHP-L12-G3/8E
L 15	G 1/2 A	PN 400	26.9	62	41	30	32	14	100	21.9	1604342081	24-VNROTPHP-L15-G1/2E
L 18	G 1/2 A	PN 400	26.9	67	45.5	36	36	14	100	31.7	1604352081	24-VNROTPHP-L18-G1/2E
L 22	G 3/4 A	PN 250	31.9	77	53.5	41	46	16	180	51.4	1604362081	24-VNROTPHP-L22-G3/4E
L 28	G 1 A	PN 250	39.9	80	54.5	50	55	18	230	71.8	1604372081	24-VNROTPHP-L28-G1E
L 35	G 1 1/4 A	PN 250	49.9	97.5	67	60	65	20	330	126.6	1604382081	24-VNROTPHP-L35-G11/4E
L 42	G 1 1/2 A	PN 250	54.9	98	65	65	70	22	500	142.9	1604392081	24-VNROTPHP-L42-G11/2E
S 6	G 1/4 A	PN 420	18.9	51	32	19	19	12	60	7.8	1604402081	24-VNROTPHP-S6-G1/4E
S 8	G 1/4 A	PN 420	18.9	51	32	19	19	12	60	7.8	1604412081	24-VNROTPHP-S8-G1/4E
S 10	G 3/8 A	PN 420	21.9	56.5	37	22	24	12	90	13.2	1604422081	24-VNROTPHP-S10-G3/8E
S 12	G 3/8 A	PN 420	21.9	56.5	37	24	27	12	90	19.5	1604432081	24-VNROTPHP-S12-G3/8E
S 16	G 1/2 A	PN 420	26.9	67	44.5	32	36	14	150	28.7	1604452081	24-VNROTPHP-S16-G1/2E
S 20	G 3/4 A	PN 420	31.9	77	50.5	41	46	16	200	46.6	1604462081	24-VNROTPHP-S20-G3/4E
S 25	G 1 A	PN 420	39.9	82.5	52.5	46	50	18	250	71.2	1604472081	24-VNROTPHP-S25-G1E
S 30	G 1 1/4 A	PN 250	49.9	94	60.5	55	60	20	500	114.7	1604482081	24-VNROTPHP-S30-G11/4E
S 38	G 1 1/2 A	PN 250	54.9	103.5	65.5	65	70	22	600	161.4	1604492081	24-VNROTPHP-S38-G11/2E

Non-return valve plug-in cartridges

Flow direction B-A

Opening pressure 1 bar
(standard version)

Standard O-ring material is NBR

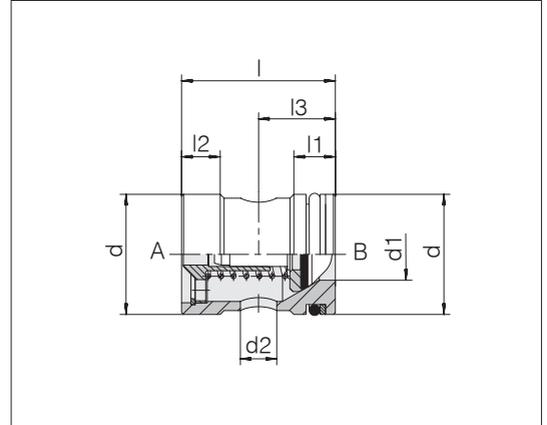

Type	Pressure	d	d1	d2	l	l1	l2	l3	kg/100 ca.	Order-No.	Designation
RVP 13	PB 400	13	4	3	23	8	6	11	1.6	0605002000	GP-VNRCO-NW13
RVP 16	PB 400	16	6	4.5	26.5	8	7	12	2.7	0605012000	GP-VNRCO-NW16
RVP 20	PB 400	20	8	6	30	9	7	14	4.3	0605022000	GP-VNRCO-NW20
RVP 24	PB 400	24	10	7	35	11	8	17	6.4	0605032000	GP-VNRCO-NW24
RVP 27	PB 400	27	12	8.5	38	11	8	18	8.9	0605042000	GP-VNRCO-NW27
RVP 35	PB 400	35	15	11	44.5	12	9.5	25	18.5	0605052000	GP-VNRCO-NW35
RVP 40	PB 250	40	19	13.5	50.5	12	11	27.5	25.2	0605062000	GP-VNRCO-NW40
RVP 47	PB 250	47	24	17	60	12	13	32	40.4	0605072000	GP-VNRCO-NW47
RVP 55	PB 250	55	30	21.5	70	14	13	42	62.6	0605082000	GP-VNRCO-NW55

Example for comp. :
RVP13

Internal valve part installation kits

Flow direction B-A

Opening pressure 1 bar
(standard version)

Standard O-ring material is NBR

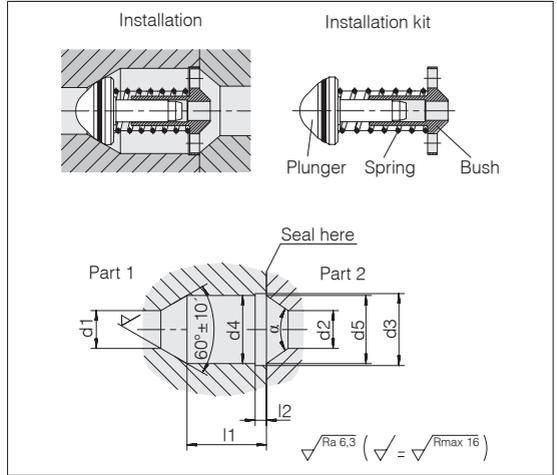

Series	d1	d2	d3 + 0.1	d4 + 0.1	d5 ± 0.1	l1 ± 0.1	l2 + 0.2	α °	Order-No.	Designation	
L 6	6	4	4	9.6	8.6	8.6	16.5	2.5	70	0669032000	GP-VNRIO-L/S6
L 8	8	6	6	11.5	10.5	10.5	16	2.5	70	0669042000	GP-VNRIO-L8
L 10	10	8	8	15.5	14.5	14.5	21.8	2.5	70	0669052000	GP-VNRIO-L10-S12
L 12	12	10	10	19	18	18	21	3	70	0669062000	GP-VNRIO-L12-S14
L 15	15	12	12	21	20	20	23	3	70	0669072000	GP-VNRIO-L15
L 18	18	15	15	26	25	25	24.5	3.5	70	0669082000	GP-VNRIO-L18
L 22	22	19	19	32	31	30.6	29.2	4	80	0669092000	GP-VNRIO-L22
L 28	28	24	24	40	39	38.5	34.5	4.5	90	0669102000	GP-VNRIO-L28
L 35	35	30	30	50	49	48.6	32.2	4.5	70	0669112000	GP-VNRIO-L35
L 42	42	36	36	56	55	54.2	31.7	5.5	70	0669122000	GP-VNRIO-L42
S 6	6	4	4	9.6	8.6	8.6	16.5	2.5	70	0669032000	GP-VNRIO-L/S6
S 8	8	5	5	11	10	10	15	2.5	70	0669132000	GP-VNRIO-S8
S 10	10	7	7	13	12	12	22	2.5	70	0669142000	GP-VNRIO-S10
S 12	12	8	8	15.5	14.5	14.5	21.8	2.5	70	0669052000	GP-VNRIO-L10-S12
S 14	14	10	10	19	18	18	21	3	70	0669062000	GP-VNRIO-L12-S14
S 16	16	12	12	22.5	21.5	21.5	24	3	70	0669152000	GP-VNRIO-S16
S 20	20	16	16	28	27	27	28	3.5	70	0669162000	GP-VNRIO-S20
S 25	25	20	20	35	34	33.6	28.7	4	70	0669172000	GP-VNRIO-S25
S 30	30	25	25	41	40	39.6	32.3	4.5	70	0669182000	GP-VNRIO-S30
S 38	38	32	32	51	50	49.2	34.7	4.5	70	0669192000	GP-VNRIO-S38

Example for comp. :
ITL06L



Shuttle valves

Ball seat

Tube installation

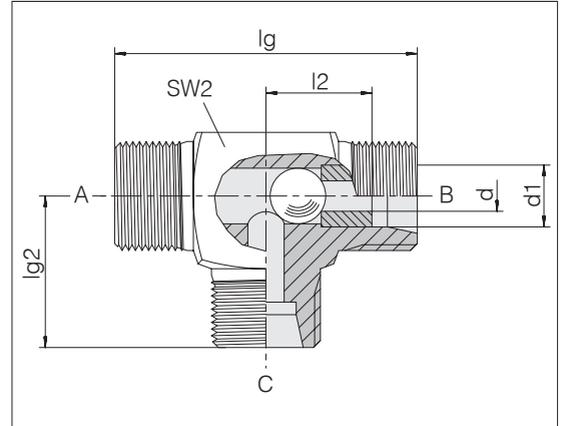
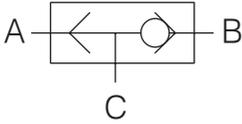

Series	Tube OD	Pressure	d	lg	lg2	l2	SW2	kg/100 ca.	Order-No.	Designation
L	8	PB 250	4.5	42	21	14	14	5.7	5690992281	24-VST-L8-P
L	10	PB 250	6	44	22	15	17	7.4	5690998281	24-VST-L10-P
L	12	PB 250	7.5	48	24	17	19	10.8	5690997081	24-VST-L12-P
L	15	PB 250	10	56	28	21	19	12.4	5690996281	24-VST-L15
S	6	PB 630	3	46	23	16	14	6.9	5690993281	24-VST-S6-P
S	8	PB 630	4.5	48	24	17	17	9.5	5690999281	24-VST-S8-P
S	10	PB 630	6	50	25	17.5	19	12.4	5690990281	24-VST-S10-P
S	12	PB 630	7.5	58	29	21.5	22	17.7	5690995281	24-VST-S12-P
S	16	PB 400	10	66	33	24.5	24	18.8	5690994281	24-VST-S16

Example for comp. :
WV08LOMD

Shuttle valves

Ball seat

with taper connection

Standard O-ring material is FPM/FKM

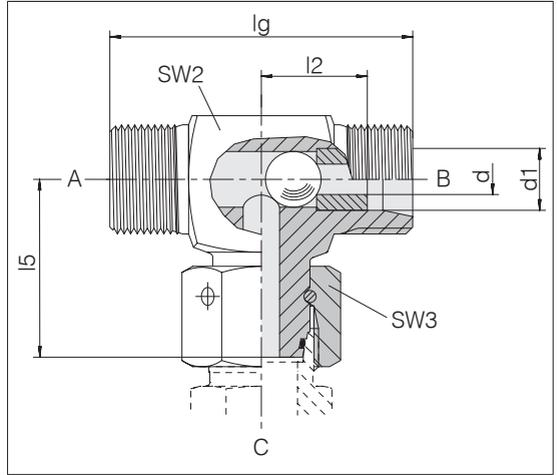
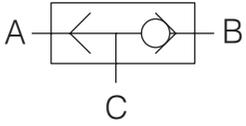

Series	Pressure	d	lg	l2	l5	SW2	SW3	kg/100 ca.	Order-No.	Designation	
Tube OD d1											
L	12	PB 250	7.5	48	17	29.5	19	22	13.4	5690991181	24-VSSWOT-L12-P

Example for comp. :
WV-ET12LOMD



Shuttle valves

Soft-sealing

Tube installation

Standard O-ring material is NBR

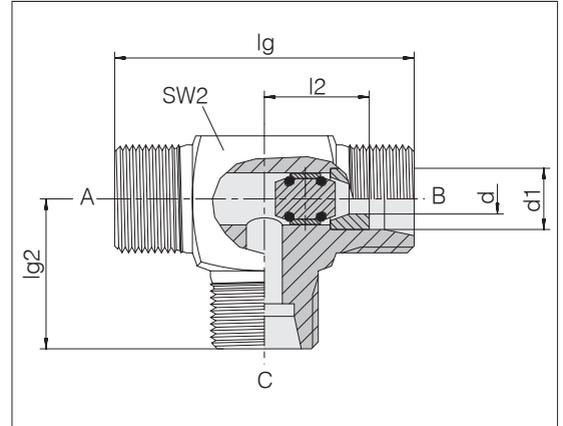
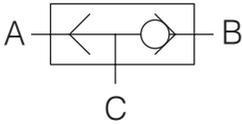

Series	Tube OD	Pressure	d	lg	lg2	l2	SW2	kg/100 ca.	Order-No.	Designation
L	8	PB 250	4.5	44	22	15	17	5.8	5690980281	24-VSOT-L8-P
L	10	PB 250	5.6	44	22	15	17	7.4	5690981281	24-VSOT-L10-P
L	12	PB 250	6.6	48	24	17	19	11.1	5690982281	24-VSOT-L12-P
L	15	PB 250	8.5	56	28	21	19	26.0	5690983281	24-VSOT-L15
S	6	PB 630	2.7	46	23	16	14	12.6	5690984281	24-VSOT-S6-P
S	8	PB 630	4.5	48	24	17	17	12.1	5690985281	24-VSOT-S8-P
S	10	PB 630	5.6	50	25	17.5	19	22.1	5690985381	24-VSOT-S10-P
S	12	PB 630	6.6	58	29	21.5	22	17.9	5690985481	24-VSOT-S12-P
S	16	PB 400	8.5	66	33	24.5	24	19.7	5690985581	24-VSOT-S16

Example for comp. :
WV08LOMD

Pre-assembly devices and tools



Content	Type/Page
The new product designations of VOSS products	P.334
Product information VOSS pre-assembly devices and tools	P.339
Pre-assembly devices	TYPE80N3 TYPE90B2 TYPE90C2 TYPE85
Forming machines	P.348 P.349 P.350 P.351 TYPE100 TYPE100C
Foot switch	P.352 P.353 FOOTSWITCH1
Tube bending device	P.354 TBM1
Thread gauge board	P.355 TIB
	P.356



Content	Type/Page
Cone gauges	CG
	P.357
Inspections gauges	TGCR
	P.358
Pre-assembly tools cutting ring assemblies	VRPT CRPT-M CRPT-PA CRCB-TYPE80 CRPT-MT
	P.359 P.360 P.361 P.362 P.363
	CRCB
	P.364
Pre-assembly tools BV-10	BV10PT/ BV10CJ
	P.365
Pre-assembly tools ZAKO / ZAKO LP	ZAKOPP/ ZAKOCJ
	P.369
Pre-assembly tools VOSSForm	SQRFH/SQRCJ
	P.374

The new designations of VOSS products



This catalog contains a new, alphanumerical product designation system based to a large extent on ISO 8434-1. This makes the designation self-explanatory and facilitates identification of the products. Since the structure is based on English, the designation is understood internationally.

Furthermore, the new product designations make it possible to generate customized special solutions by combining variations of the existing VOSS product program.

Example: TD-CRPT-L35-M-PM

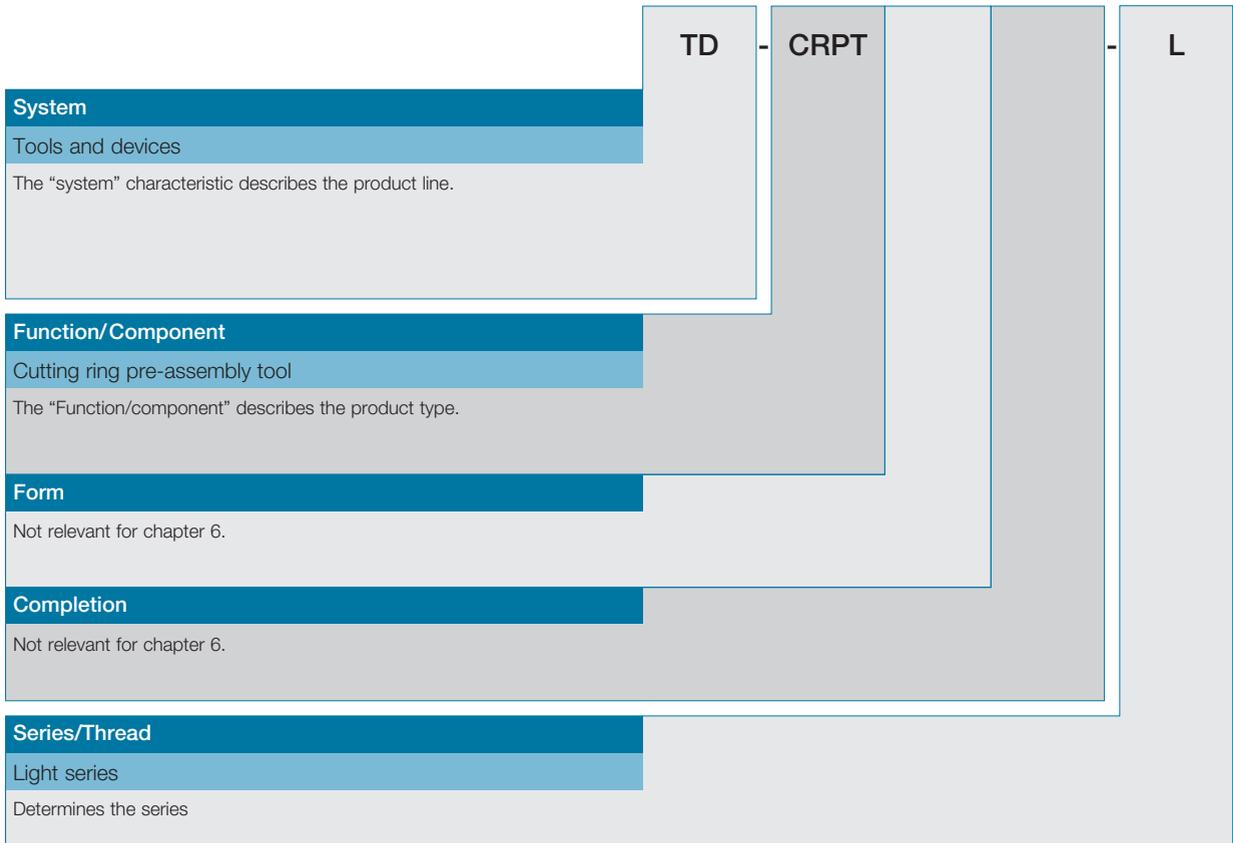

Manual pre-assembly dies made of heavy-duty steel, for tube OD L35



Examples of how to order items, as well as additional explanations and variation options are given in the respective chapters and in the following pages for the individual product groups.

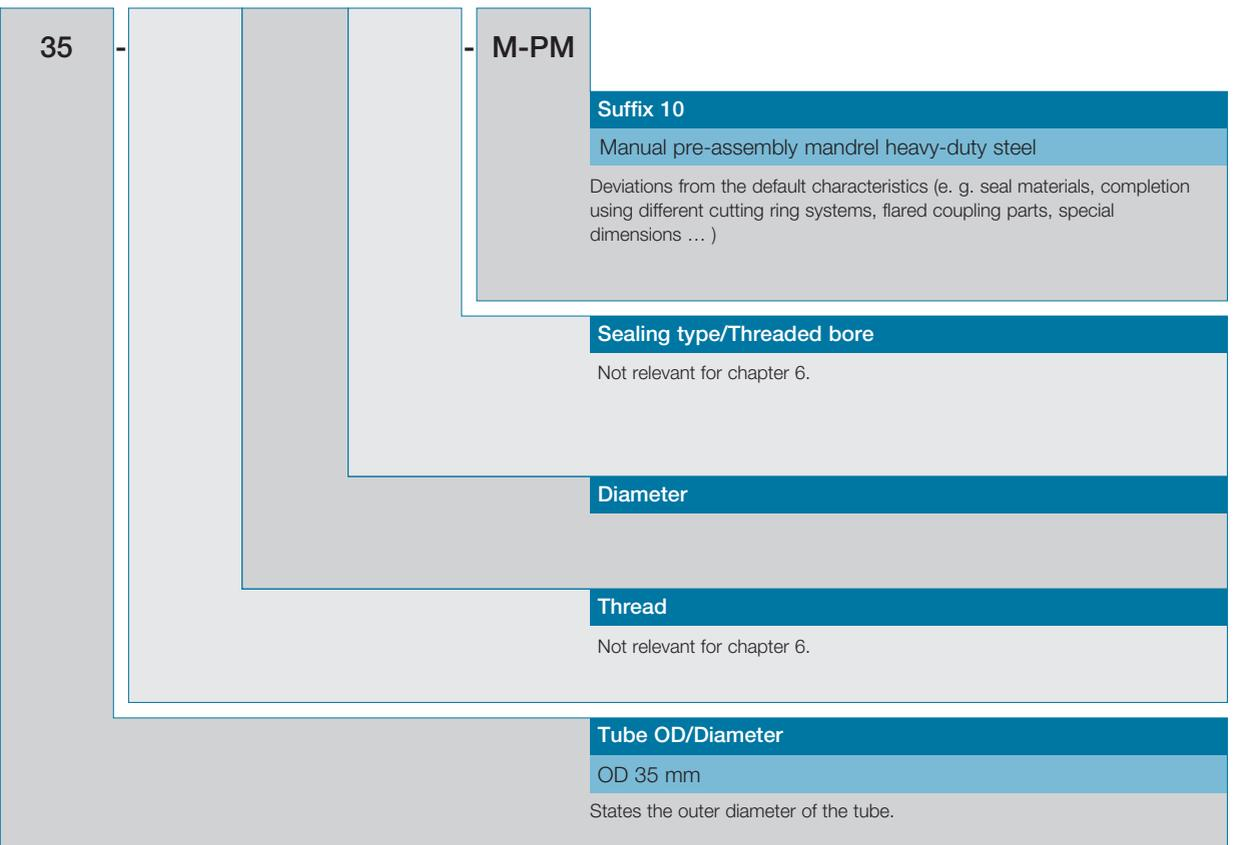

6

System	
TD	Tools and devices

Function	
Tools	
BV-10	
BV10CJ	BV-10 Clamping jaws
BV10PT	BV-10 Pre-assembly tools
Cutting rings	
CRCB	Cutting ring counter brackets
CRPT	Cutting ring pre-assembly tools
SQR	
SQRCJ	SQR Clamping jaws
SQRFH	SQR Forming heads
ZAKO	
ZAKOCJ	ZAKO Clamping jaws
ZAKOPP	ZAKO Pressure plates
ZAKOSR	ZAKO Spacer rings
Gauges	
CG	Cone gauges
TGCR	Cutting ring testing gauges
TIB	Thread identification board
Devices	
TBM1	Tube bending manual no. 1
TYPE80N3	Pre-assembly device TYPE 80N3
TYPE85	Pre-assembly device TYPE 85
TYPE90B2	Pre-assembly device TYPE 90B2
TYPE90C2	Pre-assembly device TYPE 90 Comfort
TYPE100	Pre-assembly device TYPE 100
TYPE100C	Pre-assembly device TYPE 100 Compact
DUHY1	Drive unit 1, hydraulic (number consecutively) YALE PY-07
FOOTSWITCH1	Footswitch 1 with protection cover (number consecutively) Wire Plug CA 3 LS
BV10A	BV-10 Attachments

Series/Thread	
Series	
LL	Extra light series
L	Light series
S	Heavy series
L/S	Light and heavy series are identical



	Tube OD/Diameter
6	6 mm
8	8 mm
10	10 mm
12	12 mm
14	14 mm
15	15 mm
16	16 mm
18	18 mm
20	20 mm
22	22 mm
25	25 mm
28	28 mm
30	30 mm
35	35 mm
38	38 mm
42	42 mm
48,3	48,3 mm
50	50 mm
60	60 mm
60,3	60,3 mm
65	65 mm
75	75 mm
76,1	76,1 mm
80	80 mm
88	88 mm
89,9	89,9 mm
101,6	101,6 mm
114,3	114,3 mm
1/2	1/2 inch
3/4	3/4 inch
1	1 inch
1 1/4	1 1/4 inch

Suffix overview

Suffix 6	Differing dimension
Suffix 10	Tool

Suffixes not referred to here are not relevant to this chapter.

Note: For articles having more than one relevant suffix, these are listed in numerical order in the sales designation.

Suffix 6

Differing dimension

	Inner diameter
ID3	Inner diameter 3 mm
...	...

Suffix 10	Tool
BV10A	BV-10 Attachments
DUHY1	Drive unit 1, hydraulic (number consecutively) YALE PY-07
M	Manual pre-assembly mandrel
M-PM	Manual pre-assembly mandrel heavy-duty steel
MT	Mop-top
MT-RFID	Mop-top with RFID
MT-PM-RFID	Mop-top heavy-duty steel with RFID
PA	Pin adapter
PA-PM	Pin adapter heavy-duty steel
RR8	Reserve roll 8 mm
RR10	Reserve roll 10 mm
RR12	Reserve roll 12 mm
RR14	Reserve roll 14 mm
RR15	Reserve roll 15 mm
RR16	Reserve roll 16 mm
RR18	Reserve roll 18 mm
RR20	Reserve roll 20 mm
RR22	Reserve roll 22 mm
SST	Stainless steel applications
TYPE82	pre-assembly device TYPE82
TYPE80	pre-assembly device TYPE80 (all generations)
TYPE85	pre-assembly device TYPE85
TYPE90B2	pre-assembly device TYPE90B2
TYPE90C2	pre-assembly device TYPE90C2 Comfort

Product information VOSS pre-assembly devices and tools



One-off assembly

VOSS pre-assembly devices and tools are specially designed for assembling tube couplings.

For every application, whether for one-off or series-production assembly of cutting rings, *VOSSForm^{SGR}*, BV-10 flared cone rings or ZAKO rings, a variety of tools are available – from simple aids to automatically assembly-force-controlled devices and the associated tool inserts.

The manual pre-assembly die is a simple but necessary tool for manual pre-assembly of cutting rings.

The hardened pre-assembly die guarantees that the taper cuts into the tube reliably without damaging the cone of the actual coupling connecting piece.

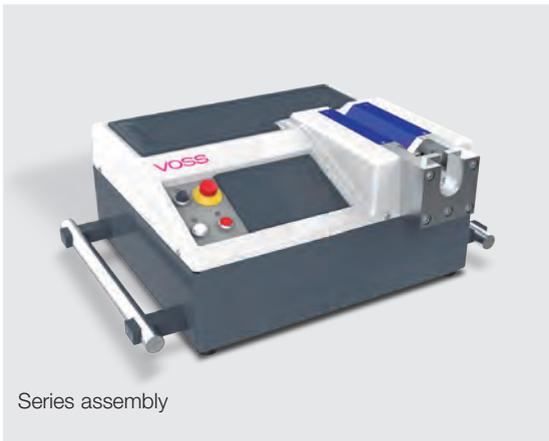

Series assembly

For series-production assembly of cutting rings, BV-10 flared cones and ZAKO rings, a wide range of devices ranging from portable hand-pump devices to permanently installed, electrically operated pre-assembly devices for outer tube diameters of 6 – 114.3 mm is available.

Reliability right down to the last detail



We at VOSS, see ourselves not only as manufacturers and suppliers of high-quality connecting components, but also as system partners who guide and support you in the entire field hydraulic tube connecting technology and help your products to be a success – all around the world. We manufacture our own systems, operate our own in-house electroplating plant, and can supply pre-assembly devices, tools and auxiliary equipment for your operations. We

also offer training courses and audits to our customers. Logistics is another important aspect for us – only products that are delivered to you reliably and on time can be used dependably in your processes. Our aim: all tube couplings must be absolutely reliable and safe. The use of VOSS pre-assembly devices which are perfectly matched to the applications and their outstanding, well-conceived features play an essential role towards achieving this aim.

Safe and reliable pre-assembly and final assembly processes

Device designation	Type 80 N3	Type 90 Basic II	Type 90 Comfort	VOSSForm 100	VOSSForm 100 Compact	Type 85
One-off assembly	X	X				
Series assembly			X	X		X
Small volume assembly					X	
Automatic tool recognition			X			
Reverse stroke optimization		X	X	X	X	
Semi-automatic tooling			X	X	X	
Touch screen			X			
Error detection			X			
Error prevention				X	X	
Including calibration service			X			
Free parameter definition acc. to customer requirements			X			
"Countdown" workpiece counter		X				
Freely programmable workpiece counter			X			
Optional pedal switch		X	X	X	X	
Tube OD	6–42 mm	6–42 mm	6–42 mm	6–42 mm	6–42 mm	38–114.3 mm
Bench-top device	X	X	X		X	X
Floor-mounted device				X		
Systems:						
Cutting ring systems	X	X	X			
BV-10 flared cone system	X	X	X			
ZAKO flange system	X	X	X			X
VOSSForm ^{SQR} / VOSSForm ^{SQRVA}				X	X	
VFS 90 (ORFS)						
Electrical connection	–	400 V	400 V	400 V	400 V	400 V
Dimensions (wxhxd) in mm	185x267x590	540x280x480	800x308x615	900x1122x943	800x951x480	340x320x650
Weight	15 kg	66 kg	90 kg	630 kg	440 kg	160 kg

Our pre-assembly devices and tools have been specially designed for one-off and for series production and match our entire coupling system right down to the last detail. We offer appropriate solutions for all requirements – safe and economical pre-assembly for initial production and for

maintenance work. From simple manual assembly tools right up to automatic devices with tool recognition, VOSS offers a wide range of tools for tubes diameters between 6 and 114.3 mm.

Always prepared

Manual pre-assembly studs



For individual cutting ring assembly using a vise.

If a cutting ring has to be replaced on-site or during servicing, a manual pre-assembly die should be used. This allows a connection to be made without subjecting the actual coupling connecting piece to wear.

- for individual manual pre-assembly work
- wear-resistant

Systems

Cutting rings VOSS *Ring*^M, 2SVA, ES-4, ES-4VA:
tube OD 6 mm – 42 mm

Applications

On-site service work requiring a vise.

See page 359 for ordering information.

The star of the construction site

VOSS Type 80 N3



Also suitable for 10° flared coupling systems

Lots of tubing at a lot of different, difficult-to-access places? The handy VOSS Type 80 N3 tool takes on any service work challenge. Its extending side surfaces allow it to be securely gripped in a vise or be bolted directly onto the workbench. Tool sets are easily exchanged and the pressure gauge, in conjunction with the settings printed on the device, ensure precision assembly results. This is THE portable field service device for pre-assembly work if no electric mains power is available.

- pressure gauge, table of settings
- new: operating lever and mounting can be removed to facilitate transportation

Systems

Cutting rings VOSS *Ring*^M, 2SVA, ES-4, ES-4VA:
tube OD 6 mm – 42 mm

BV-10: tube OD 6 mm – 42 mm

ZAKO: tube OD up to – 38 mm

Applications

Mobile device for maintenance and service work, easy assembly, with mounting options.

See page 348 for ordering information.

Serial reproducibility

VOSS Type 90 Basic II



With automatic pre-assembly and workpiece counter

One shop floor, but multiple workplaces? The easily transported VOSS Type 90 Basic II ensures reliable series pre-assembly of cutting ring couplings anywhere and everywhere with reproducible results. The automated pre-assembly process ensures consistently good results and the adjustable working pressure allows the pre-assembly process to be adjusted to match varying assembly parameters. One especially practical feature: system-related setting values are printed directly on the device casing. These can be adjusted individually and are shown clearly on a large display. The built-in count-down workpiece counter makes sure that not a single tube too many or too few is pre-assembled.

- Weighs just 66 kg
- Easy to operate, integrated workpiece counter, easy tool change
- Intelligent controls lead to short cycle times
- Pedal switch available as an option

Systems

Cutting rings VOSS *Ring*^M, 2SVA, ES-4, ES-4VA:
tube OD 6 mm – 42 mm

BV-10 (machine conversion by VOSS service)
tube OD 6 mm – 42 mm

ZAKO (machine conversion by VOSS service)
tube OD up to 38 mm

Applications

Bench-top device for shop-floor use, larger production runs

See page 349 for ordering information.

Maximum process reliability

VOSS Type 90 Comfort



Automatic RFID tool recognition prevents errors and lowers production costs

Pre-assembly work for large series production has its own special requirements. Tools have to be exchanged quickly, cycle times must be extremely short but not a single fault is permitted since this might render an entire lot unusable. The answer to such demands is the VOSS Type 90 Comfort. This device reads the RFID chips integrated in the VOSS tools and then adjusts parameters automatically to suit the tool. In this way, the shortest tooling times possible can be achieved, while effectively preventing operator errors – even when tools have to be exchanged often and fast. Simple, precise, safe and reliable – especially suitable for tight tube bends.

- Automatic pressure settings
- Tool recognition via RFID chip
- Programmable workpiece counter
- Pre-assembly controlled in relation to tool travel
- Touch-panel, intuitive menu guidance
- Including on-site calibration service
- Pedal switch available as an option
- Error detection

Systems

Cutting rings VOSS *Ring*^M, 2SVA, ES-4, ES-4VA:
tube OD 6 mm – 42 mm

BV-10 (machine conversion by VOSS service)
tube OD 6 mm – 42 mm

ZAKO (machine conversion by VOSS service)
tube OD up to 38 mm

Applications

For series production on shop floors, offering maximum process safety and reliability.

See page 350 for ordering information.

Fast, perfect tube forming

VOSSForm 100



Large-series assembly of VOSSForm^{SQR} couplings, safe operation thanks to a stop plate.

Flaring tubes to obtain the VOSSForm^{SQR} contour can be carried out easily and reliably using the VOSSForm 100. The unmistakable markings on both tools minimize assembly errors, and the stop plate for the tube end prevents insertion errors. This ensures that there is always enough tube material for shaping the contour and avoids rejects right from the start. Operating errors are prevented by automatic shaping pressure adjustment and by optical indication of the next operating step. Once the tube has been formed, the device returns to the start position under optical gate control – an ideal solution for fast-cycle mass production. Another feature which helps to achieve this is the design of the VOSSForm 100 as a complete workplace with an integrated magazine for easy-to-change tools and an additional 230 V mains outlet on the back.

- Automatic set-up to match tube size
- Cycle times from 7 (6 – 10 mm OD) to 15 seconds (25 – 42 mm OD)
- Optical gate detects end of work step and causes machine to return to start position
- Ergonomical: tool magazine lock with single-handed operation, extremely simple operation thanks to intuitive concept
- Pedal switch available as an option

Systems

VOSSForm^{SQR} and VOSSForm^{SQR}VA: tube OD 6 mm – 42 mm

Applications

Stationary device, series production, maximum process safety and reliability

See page 352 for ordering information.

The space-saving alternative

VOSSForm 100 Compact



Ready for the construction site.

The forming machine VOSSForm 100 Compact is the alternative to the VOSSForm 100 when it comes to compact external dimensions. This table unit has been designed especially for the construction site or a small volume production - allowing it to offer the same advantages as the standing unit. The VOSSForm^{SQR} tube contour in steel or stainless steel is identical – the tools can be used with both the table and standing unit. The table unit also comes with an integrated stop plate designed to prevent insertion errors. The intuitive operating concept is user friendly and quick to learn. The advantages of the Compact variant are especially apparent when transporting it: a special holder for forklifts is integrated on the bottom, sturdy crane lugs having been mounted on the top for this.

- Compact table unit variant of type 100
- Same forming process and operating comfort
- For use on the construction site or in small volume production
- Optionally available with foot switch

Systems

VOSSForm^{SQR} and VOSSForm^{SQR}VA: 6 – 42 mm tube external diameter

Applications

Transportable table unit, for the construction site or small volume production, maximum process reliability

See page 353 for ordering information.

Optimum results that can be seen – with ZAKO

VOSS Type 85



No wear and tear; protection against excessive flaring

Type 85 – a compact electro-hydraulic machine is available for pre-assembly mounting of rings for ZAKO flange couplings on tubes with outer diameters up to 114.3 mm. Easy transportation is ensured by the two-part design: separate pre-assembly cylinder plus assembly head, and external hydraulic unit. Another advantage of this construction: the forming process can be visually monitored. The actual ZAKO ring is used directly to flare the tube – there is no “tool” wear as the “tool” is turned into part of the tube coupling by the process. This means that the tube does not have to be flared in advance. As the system is so extremely simple, pre-assembly is very easy and great accuracy is obtained.

- Tool remains in the tube so that there is no tool wear
- Simple operation
- Complete assembly process can be monitored visually

Systems

ZAKO: tube OD 38 mm – 114.3 mm

Applications

Can be transported, one-off and series production

See page 351 for ordering information.

100 % fault-free cutting ring assembly

Pre-assembly studs made of high performance steel



Tool service life extended by more than 20 times plus built-in wear indicator

Two versions of the VOSS pre-assembly tools for cutting rings are available: a basic version and a more sophisticated version made of high performance steel. Normal pre-assembly studs wear faster so that they have to be checked using a gauge after every 50 pre-assembly operations. This is time-consuming, is a potential source of faults and therefore means adhering to a tool test plan. Our solution: durable tools made of high performance steel. Typical tool wear no longer occurs, there are no test and inspection intervals and the service life is very long – up to 20 times that of conventional tools. When the die reaches the usable tolerance limits, its front end breaks off, forcing the user to replace it. This ensures fault-free processes in your company.

- Basic version: accuracy has to be checked using a gauge after every 50 pre-assembly processes
- High performance steel version: no inspection/checking required, service life up to 20 times longer, clear indication when service tolerance limit is reached
- Also available as manual pre-assembly studs for use in a vise
- Version for Type 90 Comfort: contains an integrated RFID chip as well
- All tools have the same mounting and can be used in any corresponding pre-assembly device

See page 359 for ordering information.

Precise checking of gauge accuracy

VOSS Fluid taper gauges for pre-assembly studs



Hardened pre-assembly studs for the coupling of cutting rings are wear-resistant, thus achieving consistent pre-assembly results. To maintain these results, the tools must be checked at regular intervals, since they are nevertheless subject to a certain degree of wear.

In addition to a visual inspection for damage or cracks, the checks must also include verification of the die dimensions using a gauge. This involves checking the internal conical bore of the pre-assembly die after every 50 applications.

VOSS taper gauges are available individually or as a complete set containing all sizes of the light-weight and heavy duty versions in a practical plastic case.

See page 357 for ordering information.

Cutting ring geometry at a glance

VOSS Fluid test gauges for cutting ring preassembly



VOSS supplies inspection gauges to check the results of cutting ring pre-assembly and which can be used to evaluate pre-assembly in conjunction with visual inspection of the pushed-up tube material. To establish a permanently leak-tight cutting ring coupling, the pre-assembled end of the tube must contact the screw coupling connecting piece and the cutting ring must be inserted securely into the 24° conical recess. A closed force transmission path and the resulting safe connection can only be achieved by the interaction of this geometry with a strong ring of raised tube material. The VOSS taper gauge is used as an auxiliary device for evaluating cutting ring pre-assemblies and summarizing the geometry situation in the form of legible values.

Operating principle:

The results are checked by measuring the pre-assembled tube end. This is done by pushing the tube end into the conical opening of the taper gauge and screwing on the union nut manually, hand-tight, without a spanner. The pointer of the dial will move until the cutting ring cone is in contact with the tapered hole in the gauge. The indicated value must be within specified limits. If the value is below the specified range, the assembly is probably faulty and the cutting ring is too near the end of the tube. If the value is higher than the specified range, it must be assumed that the cutting ring is too far from the end of the tube.

Applications:

- Series production of tubingIncoming goods
- Inspection of preconfigured tubing

Caution!

Use of the gauge does not eliminate the need to visually check for excessive or too little pre-assembly pressures (by checking the height of tube material pushed up by the first cutting ring edge)

See page 358 for ordering information.

Prevent size confusion

VOSS thread gauge board to determine threaded stud sizes



The VOSS thread gauge board facilitates the determination of metric and imperial threaded stud sizes and prevents mistakes during assembly

The similarity of some metric and imperial threads makes it hard to distinguish between them. Furthermore, some threads can even be screwed into tapped holes which have been mistakenly assumed to have the correct thread. As such mistakes can endanger workers and the environment, we recommend that the cautionary notes in the respective standards be observed.

The VOSS thread gauge board allows the threads to be verified once more before the studs are used.

See page 356 for ordering information.

Reliable radii

VOSS tube-bending equipment



Light-weight manual bending device, vise-mounting, for accurate bending of tubes with ODs of 8 mm – 22 mm.

- For tubes with outer diameters of 8, 10, 12, 14, 16, 18, 20 and 22 mm
- Including a sturdy metal case
- Degree graduation marks on the bending templates make accurate bending of tubes easier
- Highly suitable for on-site use as the device can be simply held in a vise.

See page 355 for ordering information.

Pre-assembly devices

Type 80 N3

Manual pump pre-assembly device



Type	Order-No.	Designation
For manual pre-assembly of cutting rings on tubes with OD 6 – 42 mm, and for manual pre-assembly of flared cones and ZAKO rings up to 1 1/4".	5991080400	TD-TYPE80N3

Dimensions

Width: 190 mm

Height: 267 mm

Depth: 590 mm

Weight: 15 kg

Pre-assembly devices

Type 90 Basic II

Device for electrical mains power
400 V / 50 Hz / 3 Ph



Type	Order-No.	Designation
For machine-assisted pre-assembly of cutting rings on tubes with OD 6 – 42 mm, and for machine-assisted pre-assembly of flared cones and ZAKO rings, by means of a conversion kit (not part of standard delivery package).	5992892000	TD-TYPE90B2
Dimensions		
Width:	681 mm	
Height:	260 mm	
Depth:	520 mm	
Weight:	66 kg	
Noise level:	60 dBA	
Conversion kit	9799600140	TD-BV10A-TYPE90B2
Other power supply ratings upon request.		

Pre-assembly devices

Type 90 Comfort

Device for electrical mains power
400 V / 50 Hz / 3 Ph



Type	Order-No.	Designation
For machine-assisted pre-assembly of cutting rings on tubes with OD 6 - 42 mm, and for machine-assisted pre-assembly of flared cones and ZAKO rings, by means of a conversion kit (not part of standard delivery package).	5992893000	TD-TYPE90C2
Dimensions		
Width:	800 mm	
Height:	308 mm	
Depth:	615 mm	
Depth (with conversion kit):	636 mm	
Weight:		
Weight:	90 kg	
Noise level:	70 dBA	
Conversion kit	9799600141	TD-BV10A-TYPE90C2
Other power supply ratings upon request.		

Pre-assembly devices

Type 85

Device for electrical mains power
400 V 16 A AC
3 Ph / N / PE / 50 Hz / 0.75 kW



Type	Order-No.	Designation
For machine-assisted pre-assembly of ZAKO rings for tubes with outer diameters 38 mm – 114.3 mm incl. drive unit and high-pressure hose.	5991085000	TD-TYPE85-DUHY1
Pre-assembly cylinder Type 85 without drive unit. Device for connection to a drive unit. $P_A = \text{max. } 700 \text{ bar}$ $V = \text{min } 3\text{l}$ with hydraulic plug coupling (NW 10 coupling sleeve YALE CFY-10-10).	5991085100	TD-TYPE85
Dimensions Width: 340 mm Height: 320 mm Depth: 650 mm		
Weight: 160 kg		
Drive unit (Electric hydraulic power pack YALE PY-07).	5992361000	TD-DUHY1
Other power supply ratings upon request.		

Forming machines

VOSSForm 100

Forming machine for electrical mains power supply
400 V 16 A AC
3Ph / N / PE 50 Hz / 4 kW



Type	Order-No.	Designation
For machine-assisted forming of the VOSSForm ^{SQR} contour on steel and stainless steel tubes with ODs 6 – 42 mm.	5991008000	TD-TYPE100

5-pin CEE plug

Dimensions

Width: 900 mm

Height: 1122 mm

Depth: 943 mm

Weight: 630 kg

Noise level: < 74 dBA

Other power supply ratings upon request.

Forming machines

VOSSForm 100 Compact

Forming machine for electrical mains power supply
 400 V 16 A AC
 3Ph / N / PE 50 Hz / 3 kW



Type	Order-No.	Designation
For machine-assisted forming of the VOSSForm ^{SO_R} contour on steel and stainless steel tubes with OD 6 – 42 mm.	5992895000	TD-TYPE100C

Technical details

Minor changes to cycle times compared to Type VOSSForm 100, omission of the integrated tool magazine and cooling system

5-pin CEE plug

Dimensions

Width: 800 mm
 Height: 485 mm
 Depth: 935 mm

Weight: 440 kg
 Noise level: < 74 dBA

Other power supply ratings upon request.

Foot switch for pre-assembly devices

Connector: CA 3 LS
Protection class: IP65



Type	Order-No.	Designation
Safety foot switch with accident-prevention hood and safety interlock.	9799600139	TD-FOOTSWITCH1

For operating pre-assembly devices:

Typ 90 Basic II

Typ 90 Comfort

VOSSForm 100

VOSSForm 100 Compact

Min. cable length 3 m

Dimensions

Width: 156 mm

Height: 146 mm

Depth: 250 mm

Tube bending device

Mobile manual unit for producing precision tube bends



Type	Order-No.	Designation
Tube bending device for manual precision bending of tubes. Can be used to bend tubes with OD of 8 to 22 mm.	5994060000	TD-TBM1

The delivery package includes the following 9 bending templates:

Tube OD	Order-No.	Designation
8	5994059900	TD-TBM1-RR8
10	5994059800	TD-TBM1-RR10
12	5994059700	TD-TBM1-RR12
14	5994059600	TD-TBM1-RR14
15	5994059500	TD-TBM1-RR15
16	5994059400	TD-TBM1-RR16
18	5994059300	TD-TBM1-RR18
20	5994059200	TD-TBM1-RR20
22	5994058900	TD-TBM1-RR22

Thread gauge board

For determining thread sizes of threaded studs



Type	Order-No.	Designation
Can be used to determine following thread sizes: Metric fine thread, parallel M 10 x 1 – M 48 x 2 Inch-size Whitworth pipe thread, parallel G 1/8" – G 1 1/2"	5993571149	TD-TIB



Cone gauges for pre-assembly studs

For checking the 24° cone of a stud



Series	Order-No.	Designation
Tube OD		
L 6	5991001000	TD-CG-L/S6
L 8	5991001100	TD-CG-L/S8
L 10	5991001200	TD-CG-L/S10
L 12	5991001300	TD-CG-L/S12
L 15	5991001400	TD-CG-L15
L 18	5991001500	TD-CG-L18
L 22	5991001600	TD-CG-L22
L 28	5991001700	TD-CG-L28
L 35	5991001800	TD-CG-L35
L 42	5991001900	TD-CG-L42
S 6	5991001000	TD-CG-L/S6
S 8	5991001100	TD-CG-L/S8
S 10	5991001200	TD-CG-L/S10
S 12	5991001300	TD-CG-L/S12
S 14	5991002000	TD-CG-S14
S 16	5991002100	TD-CG-S16
S 20	5991002200	TD-CG-S20
S 25	5991002300	TD-CG-S25
S 30	5991002400	TD-CG-S30
S 38	5991002500	TD-CG-S38
Cone gages complete in handy case	5994090049	TD-CG

Inspection gauges

For inspection of cutting ring pre-assemblies

Including union nut and test pin in a handy suitcase



Series	Order-No.	Designation
Tube OD		
LL 16	5994503649	TD-TGCR-LL16
L 6	5994502249	TD-TGCR-L6
L 8	5994502349	TD-TGCR-L8
L 10	5994502449	TD-TGCR-L10
L 12	5994502549	TD-TGCR-L12
L 15	5994502649	TD-TGCR-L15
L 18	5994502749	TD-TGCR-L18
L 22	5994502849	TD-TGCR-L22
L 28	5994503749	TD-TGCR-L28
L 35	5994503849	TD-TGCR-L35
L 42	5994503949	TD-TGCR-L42
S 6	5994502949	TD-TGCR-S6
S 8	5994503049	TD-TGCR-S8
S 10	5994503149	TD-TGCR-S10
S 12	5994503249	TD-TGCR-S12
S 14	5994503349	TD-TGCR-S14
S 16	5994503449	TD-TGCR-S16
S 20	5994503549	TD-TGCR-S20
S 25	5994504049	TD-TGCR-S25
S 30	5994504149	TD-TGCR-S30
S 38	5994504249	TD-TGCR-S38

Pre-assembly tools for cutting ring assemblies

VOSS Ring-manual pre-assembly stud

VOSS Ring-pre-assembly stud

Typ 80 N3

Typ 90 Basic II

Typ 90 Comfort

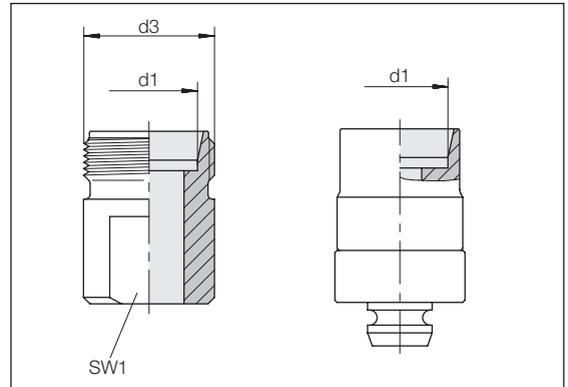

Series	d3	SW1	Order-No.	Designation	Order-No.	Designation	Order-No.	Designation
Tube OD				Manual pre-assembly stud		Manual pre-assembly stud		Pre-assembly stud
d1				Standard		High-performance steel		High-performance steel with RFID (Typ 90 Comfort)
L 6	M 12 x 1,5	10	5993234100	TD-VRPT-L6-M-PM	5993230300	TD-VRPT-L6-MT-PM	5993230349	TD-VRPT-L6-MT-PM-RFID
L 8	M 14 x 1,5	12	5993234200	TD-VRPT-L8-M-PM	5993230400	TD-VRPT-L8-MT-PM	5993230449	TD-VRPT-L8-MT-PM-RFID
L 10	M 16 x 1,5	13	5993234300	TD-VRPT-L10-M-PM	5993230500	TD-VRPT-L10-MT-PM	5993230549	TD-VRPT-L10-MT-PM-RFID
L 12	M 18 x 1,5	14	5993234400	TD-VRPT-L12-M-PM	5993230600	TD-VRPT-L12-MT-PM	5993230649	TD-VRPT-L12-MT-PM-RFID
L 15	M 22 x 1,5	19	5993234500	TD-VRPT-L15-M-PM	5993230700	TD-VRPT-L15-MT-PM	5993230749	TD-VRPT-L15-MT-PM-RFID
L 18	M 26 x 1,5	22	5993234600	TD-VRPT-L18-M-PM	5993230800	TD-VRPT-L18-MT-PM	5993230849	TD-VRPT-L18-MT-PM-RFID
L 22	M 30 x 2	24	5993234700	TD-VRPT-L22-M-PM	5993230900	TD-VRPT-L22-MT-PM	5993230949	TD-VRPT-L22-MT-PM-RFID
L 28	M 36 x 2	30	5993234800	TD-VRPT-L28-M-PM	5993231000	TD-VRPT-L28-MT-PM	5993231049	TD-VRPT-L28-MT-PM-RFID
L 35	M 45 x 2	36	5993234900	TD-VRPT-L35-M-PM	5993231100	TD-VRPT-L35-MT-PM	5993231149	TD-VRPT-L35-MT-PM-RFID
L 42	M 52 x 2	41	5993235000	TD-VRPT-L42-M-PM	5993231200	TD-VRPT-L42-MT-PM	5993231249	TD-VRPT-L42-MT-PM-RFID
S 6	M 14 x 1,5	12	5993235100	TD-VRPT-S6-M-PM	5993231300	TD-VRPT-S6-MT-PM	5993231349	TD-VRPT-S6-MT-PM-RFID
S 8	M 16 x 1,5	13	5993235200	TD-VRPT-S8-M-PM	5993231400	TD-VRPT-S8-MT-PM	5993231449	TD-VRPT-S8-MT-PM-RFID
S 10	M 18 x 1,5	14	5993235300	TD-VRPT-S10-M-PM	5993231500	TD-VRPT-S10-MT-PM	5993231549	TD-VRPT-S10-MT-PM-RFID
S 12	M 20 x 1,5	17	5993235400	TD-VRPT-S12-M-PM	5993231600	TD-VRPT-S12-MT-PM	5993231649	TD-VRPT-S12-MT-PM-RFID
S 14	M 22 x 1,5	19	5993235500	TD-VRPT-S14-M-PM	5993231700	TD-VRPT-S14-MT-PM	5993231749	TD-VRPT-S14-MT-PM-RFID
S 16	M 24 x 1,5	19	5993235600	TD-VRPT-S16-M-PM	5993231800	TD-VRPT-S16-MT-PM	5993231849	TD-VRPT-S16-MT-PM-RFID
S 20	M 30 x 2	24	5993235700	TD-VRPT-S20-M-PM	5993231900	TD-VRPT-S20-MT-PM	5993231949	TD-VRPT-S20-MT-PM-RFID
S 25	M 36 x 2	30	5993235800	TD-VRPT-S25-M-PM	5993232000	TD-VRPT-S25-MT-PM	5993232049	TD-VRPT-S25-MT-PM-RFID
S 30	M 42 x 2	36	5993235900	TD-VRPT-S30-M-PM	5993232100	TD-VRPT-S30-MT-PM	5993232149	TD-VRPT-S30-MT-PM-RFID
S 38	M 52 x 2	41	5993236000	TD-VRPT-S38-M-PM	5993232200	TD-VRPT-S38-MT-PM	5993232249	TD-VRPT-S38-MT-PM-RFID

Pre-assembly tools for cutting ring assemblies

Universal manual pre-assembly stud/mandrel

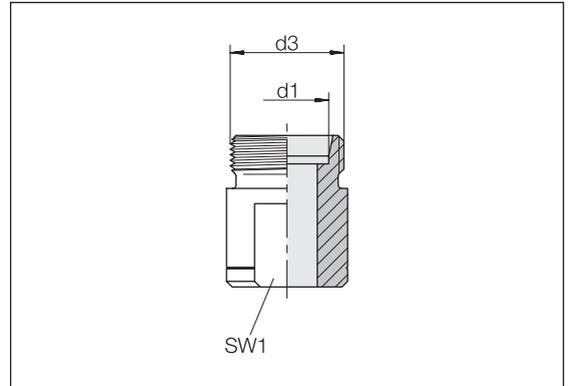

Series	d3	SW1	Order-No.	Designation	Order-No.	Designation
Tube OD				Manual pre-assembly stud		Manual pre-assembly stud
d1				Standard		High-performance steel
LL 4	M 8 x 1	7	5993950000	TD-CRPT-LL4-M	5993993000	TD-CRPT-LL4-M-PM
LL 6	M 10 x 1	9	5993952000	TD-CRPT-LL6-M	5993993200	TD-CRPT-LL6-M-PM
LL 8	M 12 x 1	11	5993953000	TD-CRPT-LL8-M	5993993300	TD-CRPT-LL8-M-PM
L 6	M 12 x 1,5	11	5993954000	TD-CRPT-L6-M	5993993400	TD-CRPT-L6-M-PM
L 8	M 14 x 1,5	12	5993955000	TD-CRPT-L8-M	5993993500	TD-CRPT-L8-M-PM
L 10	M 16 x 1,5	14	5993956000	TD-CRPT-L10-M	5993993600	TD-CRPT-L10-M-PM
L 12	M 18 x 1,5	17	5993957000	TD-CRPT-L12-M	5993993700	TD-CRPT-L12-M-PM
L 15	M 22 x 1,5	19	5993958000	TD-CRPT-L15-M	5993993800	TD-CRPT-L15-M-PM
L 18	M 26 x 1,5	24	5993959000	TD-CRPT-L18-M	5993993900	TD-CRPT-L18-M-PM
L 22	M 30 x 2	27	5993960000	TD-CRPT-L22-M	5993994000	TD-CRPT-L22-M-PM
L 28	M 36 x 2	32	5993961000	TD-CRPT-L28-M	5993994100	TD-CRPT-L28-M-PM
L 35	M 45 x 2	41	5993962000	TD-CRPT-L35-M	5993994200	TD-CRPT-L35-M-PM
L 42	M 52 x 2	46	5993963000	TD-CRPT-L42-M	5993994300	TD-CRPT-L42-M-PM
S 6	M 14 x 1,5	12	5993964000	TD-CRPT-S6-M	5993994400	TD-CRPT-S6-M-PM
S 8	M 16 x 1,5	14	5993965000	TD-CRPT-S8-M	5993994500	TD-CRPT-S8-M-PM
S 10	M 18 x 1,5	17	5993966000	TD-CRPT-S10-M	5993994600	TD-CRPT-S10-M-PM
S 12	M 20 x 1,5	17	5993967000	TD-CRPT-S12-M	5993994700	TD-CRPT-S12-M-PM
S 14	M 22 x 1,5	19	5993968000	TD-CRPT-S14-M	5993994800	TD-CRPT-S14-M-PM
S 16	M 24 x 1,5	22	5993969000	TD-CRPT-S16-M	5993994900	TD-CRPT-S16-M-PM
S 20	M 30 x 2	27	5993970000	TD-CRPT-S20-M	5993995000	TD-CRPT-S20-M-PM
S 25	M 36 x 2	32	5993971000	TD-CRPT-S25-M	5993995100	TD-CRPT-S25-M-PM
S 30	M 42 x 2	36	5993972000	TD-CRPT-S30-M	5993995200	TD-CRPT-S30-M-PM
S 38	M 52 x 2	46	5993973000	TD-CRPT-S38-M	5993995300	TD-CRPT-S38-M-PM

Pre-assembly tools for cutting ring assemblies

Type 80 N2

Universal pre-assembly stud/mandrel

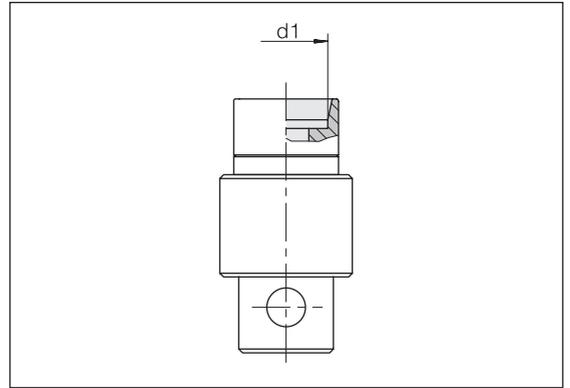

Series	Order-No.	Designation	Order-No.	Designation
Tube OD		Pre-assembly stud		Pre-assembly stud
d1		Standard		High-performance steel
LL 6	5991102000	TD-CRPT-LL6-PA		
LL 8	5991103000	TD-CRPT-LL8-PA		
L 6	5991207100	TD-CRPT-L6-PA	5993863400	TD-CRPT-L6-PA-PM
L 8	5991208100	TD-CRPT-L8-PA	5993863600	TD-CRPT-L8-PA-PM
L 10	5991209100	TD-CRPT-L10-PA	5993863800	TD-CRPT-L10-PA-PM
L 12	5991210100	TD-CRPT-L12-PA	5993864000	TD-CRPT-L12-PA-PM
L 15	5991211100	TD-CRPT-L15-PA	5993864300	TD-CRPT-L15-PA-PM
L 18	5991212100	TD-CRPT-L18-PA	5993864500	TD-CRPT-L18-PA-PM
L 22	5991213100	TD-CRPT-L22-PA	5993864700	TD-CRPT-L22-PA-PM
L 28	5991214100	TD-CRPT-L28-PA	5993864900	TD-CRPT-L28-PA-PM
L 35	5991215100	TD-CRPT-L35-PA	5993865100	TD-CRPT-L35-PA-PM
L 42	5991216100	TD-CRPT-L42-PA	5993865300	TD-CRPT-L42-PA-PM
S 6	5991217100	TD-CRPT-S6-PA	5993863500	TD-CRPT-S6-PA-PM
S 8	5991218100	TD-CRPT-S8-PA	5993863700	TD-CRPT-S8-PA-PM
S 10	5991219100	TD-CRPT-S10-PA	5993863900	TD-CRPT-S10-PA-PM
S 12	5991220100	TD-CRPT-S12-PA	5993864100	TD-CRPT-S12-PA-PM
S 14	5991221100	TD-CRPT-S14-PA	5993864200	TD-CRPT-S14-PA-PM
S 16	5991222100	TD-CRPT-S16-PA	5993864400	TD-CRPT-S16-PA-PM
S 20	5991223100	TD-CRPT-S20-PA	5993864600	TD-CRPT-S20-PA-PM
S 25	5991224100	TD-CRPT-S25-PA	5993864800	TD-CRPT-S25-PA-PM
S 30	5991225100	TD-CRPT-S30-PA	5993865000	TD-CRPT-S30-PA-PM
S 38	5991226100	TD-CRPT-S38-PA	5993865200	TD-CRPT-S38-PA-PM

Pre-assembly tools for cutting ring assemblies

Type 80 N2 / N3

Support plate

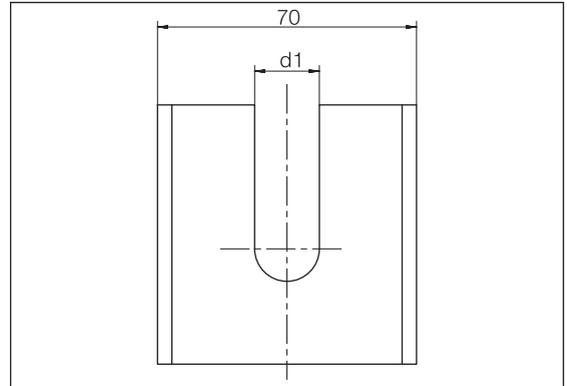

Series	Order-No.	Designation
Tube OD		Support plate
d1		Type 80 N2 / N3
LL 6	5991327100	TD-CRCB-L/S6-TYPE80
LL 8	5991328100	TD-CRCB-L/S8-TYPE80
L 6	5991327100	TD-CRCB-L/S6-TYPE80
L 8	5991328100	TD-CRCB-L/S8-TYPE80
L 10	5991329100	TD-CRCB-L/S10-TYPE80
L 12	5991330100	TD-CRCB-L/S12-TYPE80
L 15	5991331100	TD-CRCB-L15-TYPE80
L 18	5991332100	TD-CRCB-L18-TYPE80
L 22	5991333100	TD-CRCB-L22-TYPE80
L 28	5991334100	TD-CRCB-L28-TYPE80
L 35	5991335100	TD-CRCB-L35-TYPE80
L 42	5991336100	TD-CRCB-L42-TYPE80
S 6	5991327100	TD-CRCB-L/S6-TYPE80
S 8	5991328100	TD-CRCB-L/S8-TYPE80
S 10	5991329100	TD-CRCB-L/S10-TYPE80
S 12	5991330100	TD-CRCB-L/S12-TYPE80
S 14	5991337100	TD-CRCB-S14-TYPE80
S 16	5991338100	TD-CRCB-S16-TYPE80
S 20	5991339100	TD-CRCB-S20-TYPE80
S 25	5991340100	TD-CRCB-S25-TYPE80
S 30	5991341100	TD-CRCB-S30-TYPE80
S 38	5991342100	TD-CRCB-S38-TYPE80

Pre-assembly tools for cutting ring assemblies

Type 80 N3
Type 90 Basic II
Type 90 Comfort

Universal pre-assembly stud/mandrel

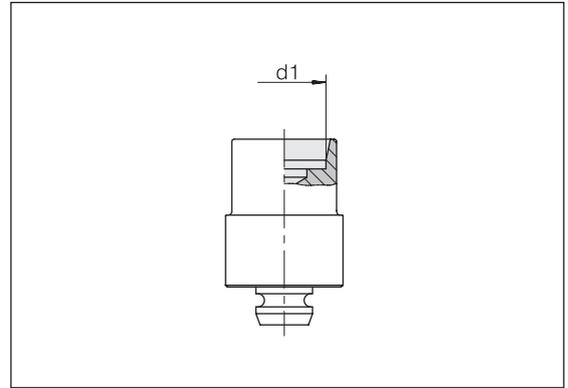

Series	Order-No.	Designation	Order-No.	Designation	Order-No.	Designation	Order-No.	Designation
Tube OD		Pre-assembly stud		Pre-assembly stud		Pre-assembly stud		Pre-assembly stud
d1		Standard		Standard with RFID (Type 90 Comfort)		High-performance steel		High-performance steel with RFID (Type 90 Comfort)
LL 6	5991102100	TD-CRPT-LL6-MT			5993867400	TD-CRPT-LL6-MT-PM	5993992500	TD-CRPT-LL6-MT-PM-RFID
LL 8	5991103100	TD-CRPT-LL8-MT			5993867300	TD-CRPT-LL8-MT-PM	5993992600	TD-CRPT-LL8-MT-PM-RFID
L 6	5991207300	TD-CRPT-L6-MT	5993850700	TD-CRPT-L6-MT-RFID	5993861400	TD-CRPT-L6-MT-PM	5993870700	TD-CRPT-L6-MT-PM-RFID
L 8	5991208300	TD-CRPT-L8-MT	5993850900	TD-CRPT-L8-MT-RFID	5993861600	TD-CRPT-L8-MT-PM	5993870900	TD-CRPT-L8-MT-PM-RFID
L 10	5991209300	TD-CRPT-L10-MT	5993851100	TD-CRPT-L10-MT-RFID	5993861800	TD-CRPT-L10-MT-PM	5993871100	TD-CRPT-L10-MT-PM-RFID
L 12	5991210300	TD-CRPT-L12-MT	5993851300	TD-CRPT-L12-MT-RFID	5993862000	TD-CRPT-L12-MT-PM	5993871300	TD-CRPT-L12-MT-PM-RFID
L 15	5991211300	TD-CRPT-L15-MT	5993851600	TD-CRPT-L15-MT-RFID	5993862300	TD-CRPT-L15-MT-PM	5993871600	TD-CRPT-L15-MT-PM-RFID
L 18	5991212300	TD-CRPT-L18-MT	5993851800	TD-CRPT-L18-MT-RFID	5993862500	TD-CRPT-L18-MT-PM	5993871800	TD-CRPT-L18-MT-PM-RFID
L 22	5991213300	TD-CRPT-L22-MT	5993852000	TD-CRPT-L22-MT-RFID	5993862700	TD-CRPT-L22-MT-PM	5993872000	TD-CRPT-L22-MT-PM-RFID
L 28	5991214300	TD-CRPT-L28-MT	5993852200	TD-CRPT-L28-MT-RFID	5993862900	TD-CRPT-L28-MT-PM	5993872200	TD-CRPT-L28-MT-PM-RFID
L 35	5991215300	TD-CRPT-L35-MT	5993852400	TD-CRPT-L35-MT-RFID	5993863100	TD-CRPT-L35-MT-PM	5993872400	TD-CRPT-L35-MT-PM-RFID
L 42	5991216300	TD-CRPT-L42-MT	5993852600	TD-CRPT-L42-MT-RFID	5993863300	TD-CRPT-L42-MT-PM	5993872600	TD-CRPT-L42-MT-PM-RFID
S 6	5991217300	TD-CRPT-S6-MT	5993850800	TD-CRPT-S6-MT-RFID	5993861500	TD-CRPT-S6-MT-PM	5993870800	TD-CRPT-S6-MT-PM-RFID
S 8	5991218300	TD-CRPT-S8-MT	5993851000	TD-CRPT-S8-MT-RFID	5993861700	TD-CRPT-S8-MT-PM	5993871000	TD-CRPT-S8-MT-PM-RFID
S 10	5991219300	TD-CRPT-S10-MT	5993851200	TD-CRPT-S10-MT-RFID	5993861900	TD-CRPT-S10-MT-PM	5993871200	TD-CRPT-S10-MT-PM-RFID
S 12	5991220300	TD-CRPT-S12-MT	5993851400	TD-CRPT-S12-MT-RFID	5993862100	TD-CRPT-S12-MT-PM	5993871400	TD-CRPT-S12-MT-PM-RFID
S 14	5991221300	TD-CRPT-S14-MT	5993851500	TD-CRPT-S14-MT-RFID	5993862200	TD-CRPT-S14-MT-PM	5993871500	TD-CRPT-S14-MT-PM-RFID
S 16	5991222300	TD-CRPT-S16-MT	5993851700	TD-CRPT-S16-MT-RFID	5993862400	TD-CRPT-S16-MT-PM	5993871700	TD-CRPT-S16-MT-PM-RFID
S 20	5991223300	TD-CRPT-S20-MT	5993851900	TD-CRPT-S20-MT-RFID	5993862600	TD-CRPT-S20-MT-PM	5993871900	TD-CRPT-S20-MT-PM-RFID
S 25	5991224300	TD-CRPT-S25-MT	5993852100	TD-CRPT-S25-MT-RFID	5993862800	TD-CRPT-S25-MT-PM	5993872100	TD-CRPT-S25-MT-PM-RFID
S 30	5991225300	TD-CRPT-S30-MT	5993852300	TD-CRPT-S30-MT-RFID	5993863000	TD-CRPT-S30-MT-PM	5993872300	TD-CRPT-S30-MT-PM-RFID
S 38	5991226300	TD-CRPT-S38-MT	5993852500	TD-CRPT-S38-MT-RFID	5993863200	TD-CRPT-S38-MT-PM	5993872500	TD-CRPT-S38-MT-PM-RFID

Pre-assembly tools for cutting ring assemblies

Type 90 Basic II
Type 90 Comfort

Support plate

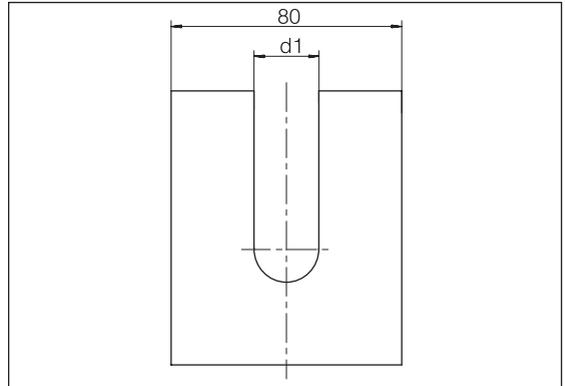

Series	Order-No.	Designation
Tube OD		Support plate
d1		
LL 6	5991327300	TD-CRCB-L/S6
LL 8	5991328300	TD-CRCB-L/S8
L 6	5991327300	TD-CRCB-L/S6
L 8	5991328300	TD-CRCB-L/S8
L 10	5991329300	TD-CRCB-L/S10
L 12	5991330300	TD-CRCB-L/S12
L 15	5991331300	TD-CRCB-L15
L 18	5991332300	TD-CRCB-L18
L 22	5991333300	TD-CRCB-L22
L 28	5991334300	TD-CRCB-L28
L 35	5991335300	TD-CRCB-L35
L 42	5991336300	TD-CRCB-L42
S 6	5991327300	TD-CRCB-L/S6
S 8	5991328300	TD-CRCB-L/S8
S 10	5991329300	TD-CRCB-L/S10
S 12	5991330300	TD-CRCB-L/S12
S 14	5991337300	TD-CRCB-S14
S 16	5991338300	TD-CRCB-S16
S 20	5991339300	TD-CRCB-S20
S 25	5991340300	TD-CRCB-S25
S 30	5991341300	TD-CRCB-S30
S 38	5991342300	TD-CRCB-S38

Pre-assembly tools for BV-10 flared coned assembly

Type 80 N
Type 80 N2

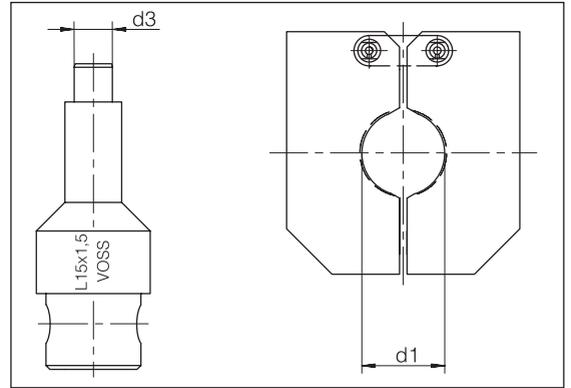

Series	d3	Order-No.	Designation	Order-No.	Designation
Tube OD			Pre-assembly stud		Clamping jaws
d1 x s					
L 6 x 1	2,9	5993050000	TD-BV10PT-L6x1-PA	5993000000	TD-BV10CJ-L/S6
L 8 x 1	4,9	5993050100	TD-BV10PT-L8x1-PA	5993001000	TD-BV10CJ-L/S8
L 10 x 1	6,3	5993050200	TD-BV10PT-L10x1-PA	5993002000	TD-BV10CJ-L/S10
L 10 x 1,5	5,5	5993050300	TD-BV10PT-L/S10x1,5-PA	5993002000	TD-BV10CJ-L/S10
L 12 x 1	8,0	5993050400	TD-BV10PT-L12x1-PA	5993003000	TD-BV10CJ-L/S12
L 12 x 1,5	7,5	5993050500	TD-BV10PT-L/S12x1,5-PA	5993003000	TD-BV10CJ-L/S12
L 15 x 1,5	10,2	5993050600	TD-BV10PT-L15x1,5-PA	5993004000	TD-BV10CJ-L15
L 15 x 2	9,1	5993050700	TD-BV10PT-L15x2-PA	5993004000	TD-BV10CJ-L15
L 18 x 1,5	13,0	5993050800	TD-BV10PT-L18x1,5-PA	5993005000	TD-BV10CJ-L18
L 18 x 2	12,0	5993050900	TD-BV10PT-L18x2-PA	5993005000	TD-BV10CJ-L18
L 22 x 1,5	16,2	5993051000	TD-BV10PT-L22x1,5/22x2-PA	5993006000	TD-BV10CJ-L22
L 22 x 2	16,2	5993051000	TD-BV10PT-L22x1,5/22x2-PA	5993006000	TD-BV10CJ-L22
L 28 x 2	21,0	5993051100	TD-BV10PT-L28x2/28x2,5-PA	5993007000	TD-BV10CJ-L28
L 28 x 2,5	21,0	5993051100	TD-BV10PT-L28x2/28x2,5-PA	5993007000	TD-BV10CJ-L28
L 28 x 3	19,5	5993051200	TD-BV10PT-L28x3-PA	5993007000	TD-BV10CJ-L28
L 35 x 2	28,5	5993051300	TD-BV10PT-L35x2-PA	5993008000	TD-BV10CJ-L35
L 35 x 3	26,5	5993051400	TD-BV10PT-L35x3/35x3,5-PA	5993008000	TD-BV10CJ-L35
L 35 x 3,5	26,5	5993051400	TD-BV10PT-L35x3/35x3,5-PA	5993008000	TD-BV10CJ-L35
L 42 x 3	33,5	5993051600	TD-BV10PT-L42x3-PA	5993009000	TD-BV10CJ-L42

Locking plate available upon request.

Pre-assembly tools for BV-10 flared coned assembly

Type 80 N
Type 80 N2

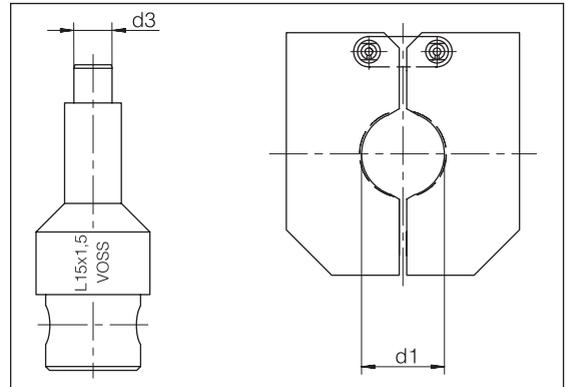

Series	d3	Order-No.	Designation	Order-No.	Designation
Tube OD			Pre-assembly stud		Clamping jaws
d1 x s					
S 8 x 1,5	4	5993051800	TD-BV10PT-S8x1,5-PA	5993001000	TD-BV10CJ-L/S8
S 8 x 2	3	5993051900	TD-BV10PT-S8x2-PA	5993001000	TD-BV10CJ-L/S8
S 10 x 1,5	5,5	5993050300	TD-BV10PT-L/S10x1,5-PA	5993002000	TD-BV10CJ-L/S10
S 10 x 2	4,5	5993052000	TD-BV10PT-S10x2/12x3-PA	5993002000	TD-BV10CJ-L/S10
S 12 x 1,5	7,5	5993050500	TD-BV10PT-L/S12x1,5-PA	5993003000	TD-BV10CJ-L/S12
S 12 x 2	6,5	5993052100	TD-BV10PT-S12x2-PA	5993003000	TD-BV10CJ-L/S12
S 12 x 3	4,5	5993052000	TD-BV10PT-S10x2/12x3-PA	5993003000	TD-BV10CJ-L/S12
S 14 x 2	8,5	5993052200	TD-BV10PT-S14x2/16x3-PA	5993014000	TD-BV10CJ-S14
S 14 x 3	6	5993052300	TD-BV10PT-S14x3-PA	5993014000	TD-BV10CJ-S14
S 16 x 2	10,5	5993052400	TD-BV10PT-S16x2-PA	5993015000	TD-BV10CJ-S16
S 16 x 2,5	9,5	5993052500	TD-BV10PT-S16x2,5-PA	5993015000	TD-BV10CJ-S16
S 16 x 3	8,5	5993052200	TD-BV10PT-S14x2/16x3-PA	5993015000	TD-BV10CJ-S16
S 20 x 2	13,5	5993052600	TD-BV10PT-S20x2/20x2,5-PA	5993016000	TD-BV10CJ-S20
S 20 x 2,5	13,5	5993052600	TD-BV10PT-S20x2/20x2,5-PA	5993016000	TD-BV10CJ-S20
S 20 x 3	12,5	5993052700	TD-BV10PT-S20x3-PA	5993016000	TD-BV10CJ-S20
S 20 x 3,5	11	5993052800	TD-BV10PT-S20x3,5-PA	5993016000	TD-BV10CJ-S20
S 20 x 4	10	5993057800	TD-BV10PT-S20x4-PA	5993016000	TD-BV10CJ-S20
S 25 x 2,5	18	5993053000	TD-BV10PT-S25x2,5-PA	5993017000	TD-BV10CJ-S25
S 25 x 3	17	5993053100	TD-BV10PT-S25x3/30x5-PA	5993017000	TD-BV10CJ-S25
S 25 x 4	15	5993053200	TD-BV10PT-S25x4-PA	5993017000	TD-BV10CJ-S25
S 30 x 3	22	5993053300	TD-BV10PT-S30x3-PA	5993018000	TD-BV10CJ-S30
S 30 x 4	20	5993053400	TD-BV10PT-S30x4-PA	5993018000	TD-BV10CJ-S30
S 30 x 5	17	5993053100	TD-BV10PT-S25x3/30x5-PA	5993018000	TD-BV10CJ-S30
S 38 x 3	30	5993053500	TD-BV10PT-S38x3-PA	5993019000	TD-BV10CJ-S38
S 38 x 4	27	5993053600	TD-BV10PT-S38x4-PA	5993019000	TD-BV10CJ-S38
S 38 x 5	26	5993053700	TD-BV10PT-S38x5-PA	5993019000	TD-BV10CJ-S38
S 38 x 6	23	5993053800	TD-BV10PT-S38x6-PA	5993019000	TD-BV10CJ-S38

Locking plate available upon request.

Pre-assembly tools for BV-10 flared coned assembly

Type 80 N3
Type 90 Basic II
Type 90 Comfort

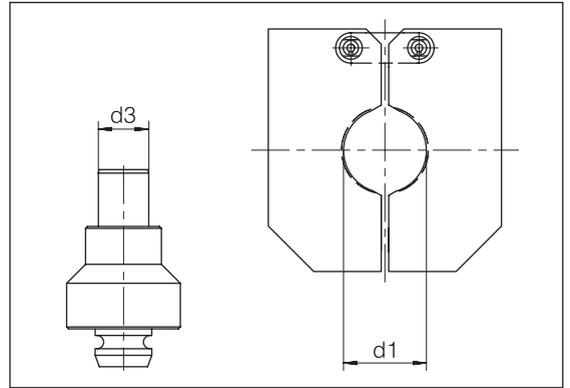

Series	d3	Order-No.	Designation	Order-No.	Designation
Tube OD			Pre-assembly stud		Clamping jaws
d1 x s					
L 6 x 1	2,9	5993020100	TD-BV10PT-L6x1-MT	5993000000	TD-BV10CJ-L/S6
L 8 x 1	4,9	5993020200	TD-BV10PT-L8x1-MT	5993001000	TD-BV10CJ-L/S8
L 10 x 1	6,3	5993020300	TD-BV10PT-L10x1-MT	5993002000	TD-BV10CJ-L/S10
L 10 x 1,5	5,5	5993020400	TD-BV10PT-L/S10x1,5-MT	5993002000	TD-BV10CJ-L/S10
L 12 x 1	8,0	5993020500	TD-BV10PT-L12x1-MT	5993003000	TD-BV10CJ-L/S12
L 12 x 1,5	7,5	5993020600	TD-BV10PT-L/S12x1,5-MT	5993003000	TD-BV10CJ-L/S12
L 15 x 1,5	10,2	5993020700	TD-BV10PT-L15x1,5-MT	5993004000	TD-BV10CJ-L15
L 15 x 2	9,1	5993020800	TD-BV10PT-L15x2-MT	5993004000	TD-BV10CJ-L15
L 18 x 1,5	13,0	5993020900	TD-BV10PT-L18x1,5-MT	5993005000	TD-BV10CJ-L18
L 18 x 2	12,0	5993021000	TD-BV10PT-L18x2-MT	5993005000	TD-BV10CJ-L18
L 22 x 1,5	16,2	5993021100	TD-BV10PT-L22x1,5/22x2-MT	5993006000	TD-BV10CJ-L22
L 22 x 2	16,2	5993021100	TD-BV10PT-L22x1,5/22x2-MT	5993006000	TD-BV10CJ-L22
L 28 x 2	21,0	5993021200	TD-BV10PT-L28x2/28x2,5-MT	5993007000	TD-BV10CJ-L28
L 28 x 2,5	21,0	5993021200	TD-BV10PT-L28x2/28x2,5-MT	5993007000	TD-BV10CJ-L28
L 28 x 3	19,5	5993021300	TD-BV10PT-L28x3-MT	5993007000	TD-BV10CJ-L28
L 35 x 2	28,5	5993021400	TD-BV10PT-L35x2-MT	5993008000	TD-BV10CJ-L35
L 35 x 3	26,5	5993021500	TD-BV10PT-L35x3/35x3,5-MT	5993008000	TD-BV10CJ-L35
L 35 x 3,5	26,5	5993021500	TD-BV10PT-L35x3/35x3,5-MT	5993008000	TD-BV10CJ-L35
L 42 x 3	33,5	5993021700	TD-BV10PT-L42x3-MT	5993009000	TD-BV10CJ-L42

Locking plate available upon request.

Pre-assembly tools for BV-10 flared coned assembly

Type 80 N3
Type 90 Basic II
Type 90 Comfort

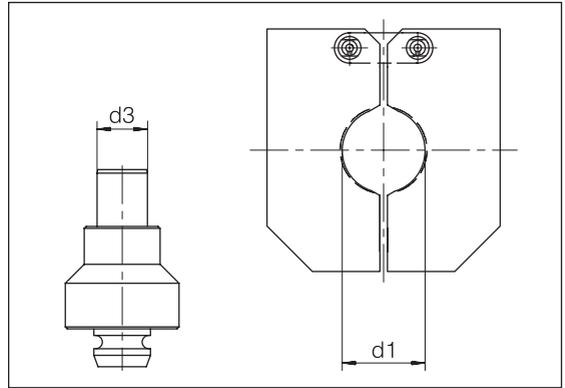

Series	d3	Order-No.	Designation	Order-No.	Designation
Tube OD			Pre-assembly stud		Clamping jaws
d1 x s					
S 8 x 1,5	4	5993021800	TD-BV10PT-S8x1,5-MT	5993001000	TD-BV10CJ-L/S8
S 8 x 2	3	5993021900	TD-BV10PT-S8x2-MT	5993001000	TD-BV10CJ-L/S8
S 10 x 1,5	5,5	5993020400	TD-BV10PT-L/S10x1,5-MT	5993002000	TD-BV10CJ-L/S10
S 10 x 2	4,5	5993022000	TD-BV10PT-S10x2/12x3-MT	5993002000	TD-BV10CJ-L/S10
S 12 x 1,5	7,5	5993020600	TD-BV10PT-L/S12x1,5-MT	5993003000	TD-BV10CJ-L/S12
S 12 x 2	6,5	5993022100	TD-BV10PT-S12x2-MT	5993003000	TD-BV10CJ-L/S12
S 12 x 3	4,5	5993022000	TD-BV10PT-S10x2/12x3-MT	5993003000	TD-BV10CJ-L/S12
S 14 x 2	8,5	5993022200	TD-BV10PT-S14x2/16x3-MT	5993014000	TD-BV10CJ-S14
S 14 x 3	6	5993022300	TD-BV10PT-S14x3-MT	5993014000	TD-BV10CJ-S14
S 16 x 2	10,5	5993022400	TD-BV10PT-S16x2-MT	5993015000	TD-BV10CJ-S16
S 16 x 2,5	9,5	5993022500	TD-BV10PT-S16x2,5-MT	5993015000	TD-BV10CJ-S16
S 16 x 3	8,5	5993022200	TD-BV10PT-S14x2/16x3-MT	5993015000	TD-BV10CJ-S16
S 20 x 2	13,5	5993022600	TD-BV10PT-S20x2/20x2,5-MT	5993016000	TD-BV10CJ-S20
S 20 x 2,5	13,5	5993022600	TD-BV10PT-S20x2/20x2,5-MT	5993016000	TD-BV10CJ-S20
S 20 x 3	12,5	5993022700	TD-BV10PT-S20x3-MT	5993016000	TD-BV10CJ-S20
S 20 x 3,5	11	5993022800	TD-BV10PT-S20x3,5-MT	5993016000	TD-BV10CJ-S20
S 20 x 4	10	5993023900	TD-BV10PT-S20x4-MT	5993016000	TD-BV10CJ-S20
S 25 x 2,5	18	5993023000	TD-BV10PT-S25x2,5-MT	5993017000	TD-BV10CJ-S25
S 25 x 3	17	5993023100	TD-BV10PT-S25x3/30x5-MT	5993017000	TD-BV10CJ-S25
S 25 x 4	15	5993023200	TD-BV10PT-S25x4-MT	5993017000	TD-BV10CJ-S25
S 30 x 3	22	5993023300	TD-BV10PT-S30x3-MT	5993018000	TD-BV10CJ-S30
S 30 x 4	20	5993023400	TD-BV10PT-S30x4-MT	5993018000	TD-BV10CJ-S30
S 30 x 5	17	5993023100	TD-BV10PT-S25x3/30x5-MT	5993018000	TD-BV10CJ-S30
S 38 x 3	30	5993023500	TD-BV10PT-S38x3-MT	5993019000	TD-BV10CJ-S38
S 38 x 4	27	5993023600	TD-BV10PT-S38x4-MT	5993019000	TD-BV10CJ-S38
S 38 x 5	26	5993023700	TD-BV10PT-S38x5-MT	5993019000	TD-BV10CJ-S38
S 38 x 6	23	5993023800	TD-BV10PT-S38x6-MT	5993019000	TD-BV10CJ-S38

Locking plate available upon request.

Pre-assembly tools for ZAKO ring assembly

Type 80 N
Type 80 N2

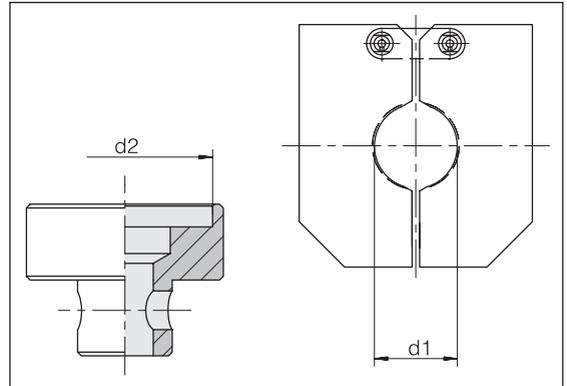

Flange size NW	d2	Order-No.	Designation Pre-assembly stud	Tube OD d1	Order-No.	Designation Clamping jaws
1/2"	30,3	5993065100	TD-ZAKOPP-1/2-PA	16	5993015000	TD-BV10CJ-S16
3/4"	38,3	5993066100	TD-ZAKOPP-3/4-PA	20	5993016000	TD-BV10CJ-S20
3/4"	38,3	5993066100	TD-ZAKOPP-3/4-PA	25	5993017000	TD-BV10CJ-S25
1"	38,3	5993066100	TD-ZAKOPP-3/4-PA	25	5993017000	TD-BV10CJ-S25
1"	46,3	5993067100	TD-ZAKOPP-1-PA	30	5993018000	TD-BV10CJ-S30
1"	46,3	5993067100	TD-ZAKOPP-1-PA	38	5993019000	TD-BV10CJ-S38
1 1/4"	46,3	5993067100	TD-ZAKOPP-1-PA	30	5993018000	TD-BV10CJ-S30
1 1/4"	52,3	5993068100	TD-ZAKOPP-1 1/4-PA	38	5993019000	TD-BV10CJ-S38
1 1/4"	52,3	5993068100	TD-ZAKOPP-1 1/4-PA	42	5993009000	TD-BV10CJ-S42

Locking plate available upon request.

Pre-assembly tools for ZAKO ring assembly

Type 80 N3
Type 90 Basic II
Type 90 Comfort

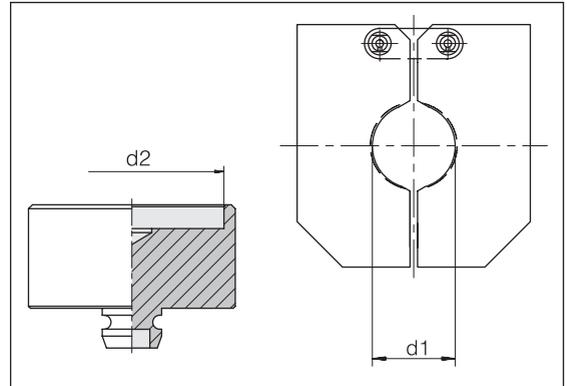

Flange size	d2	Order-No.	Designation	Tube OD	Order-No.	Designation
NW			Pre-assembly stud	d1		Clamping jaws
1/2"	30,3	5993065300	TD-ZAKOPP-1/2-MT	16	5993015000	TD-BV10CJ-S16
3/4"	38,3	5993066300	TD-ZAKOPP-3/4-MT	20	5993016000	TD-BV10CJ-S20
3/4"	38,3	5993066300	TD-ZAKOPP-3/4-MT	25	5993017000	TD-BV10CJ-S25
1"	38,3	5993066300	TD-ZAKOPP-3/4-MT	25	5993017000	TD-BV10CJ-S25
1"	46,3	5993067300	TD-ZAKOPP-1-MT	30	5993018000	TD-BV10CJ-S30
1"	46,3	5993067300	TD-ZAKOPP-1-MT	38	5993019000	TD-BV10CJ-S38
1 1/4"	46,3	5993067300	TD-ZAKOPP-1-MT	30	5993018000	TD-BV10CJ-S30
1 1/4"	52,3	5993068400	TD-ZAKOPP-11/4-MT	38	5993019000	TD-BV10CJ-S38
1 1/4"	52,3	5993068400	TD-ZAKOPP-11/4-MT	42	5993009000	TD-BV10CJ-S42

Locking plate available upon request.

Pre-assembly tools for ZAKO ring assembly

Typ 82

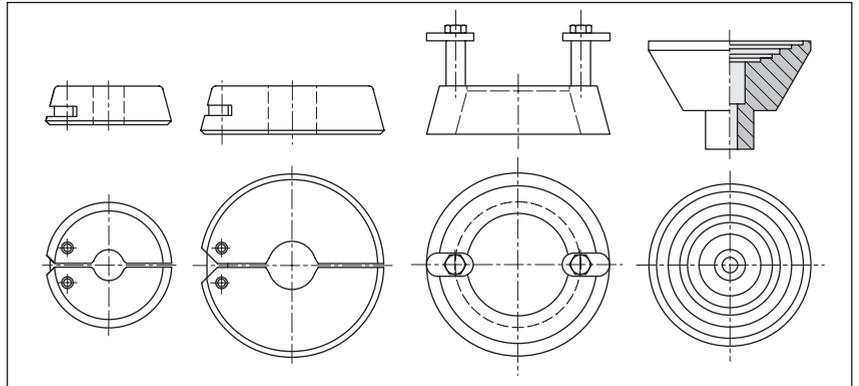

Tube OD	Order-No.	Designation	Order-No.	Designation	Order-No.	Designation	Order-No.	Designation
		Clamping jaws		Clamping jaws		Spacer ring		Pressure plate
16	5514963100	TD-ZAKOCJ-16-TYPE82			5514978000	TD-ZAKOSR-TYPE82	5514980000	TD-ZAKOPP-16-65-TYPE82
20	5514964100	TD-ZAKOCJ-20-TYPE82			5514978000	TD-ZAKOSR-TYPE82	5514980000	TD-ZAKOPP-16-65-TYPE82
25			5514965200	TD-ZAKOCJ-25-TYPE82			5514980000	TD-ZAKOPP-16-65-TYPE82
30			5514966200	TD-ZAKOCJ-30-TYPE82			5514980000	TD-ZAKOPP-16-65-TYPE82
38			5514967200	TD-ZAKOCJ-38-TYPE82			5514980000	TD-ZAKOPP-16-65-TYPE82
50			5514968100	TD-ZAKOCJ-50-TYPE82			5514980000	TD-ZAKOPP-16-65-TYPE82
60			5514968249	TD-ZAKOCJ-60-TYPE82			5514980000	TD-ZAKOPP-16-65-TYPE82
65			5514969100	TD-ZAKOCJ-65-TYPE82			5514980000	TD-ZAKOPP-16-65-TYPE82

Pre-assembly
tools for
ZAKO ring
assembly

Type 85

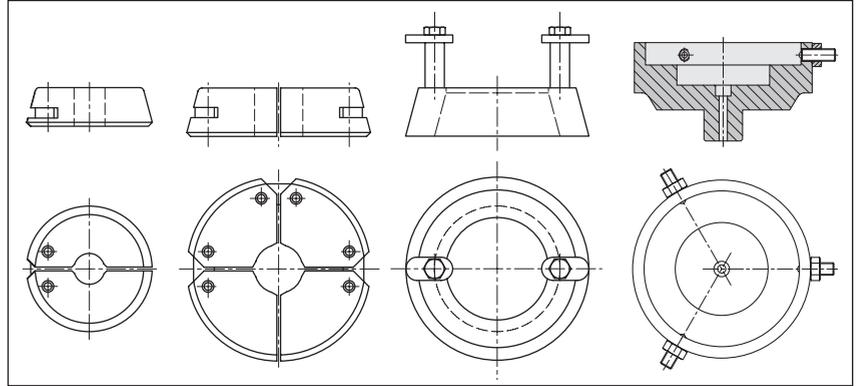

Tube OD	Order-No.	Designation	Order-No.	Designation	Order-No.	Designation	Order-No.	Designation
	Clamping jaws		Clamping jaws		Spacer ring		Pressure plate	
38	5514940049	TD-ZAKOCJ-38-TYPE85			5514978100	TD-ZAKOSR-TYPE85	5993802749	TD-ZAKOPP-38-TYPE85
50	5514940149	TD-ZAKOCJ-50-TYPE85			5514978100	TD-ZAKOSR-TYPE85	5993801849	TD-ZAKOPP-48,3/50-TYPE85
60	5514940249	TD-ZAKOCJ-60-TYPE85			5514978100	TD-ZAKOSR-TYPE85	5993801949	TD-ZAKOPP-60-TYPE85
65	5514940349	TD-ZAKOCJ-65-TYPE85			5514978100	TD-ZAKOSR-TYPE85	5993802049	TD-ZAKOPP-65-TYPE85
75			5514940949	TD-ZAKOCJ-75-TYPE85			5993802149	TD-ZAKOPP-75-TYPE85
80			5514940449	TD-ZAKOCJ-80-TYPE85			5993802249	TD-ZAKOPP-76,1/80-TYPE85
88			5514940549	TD-ZAKOCJ-88-TYPE85			5993802349	TD-ZAKOPP-88-TYPE85
101,6			5514940649	TD-ZAKOCJ-101,6-TYPE85			5993802449	TD-ZAKOPP-88,9/101,6-TYPE85
114,3			5514940749	TD-ZAKOCJ-114,3-TYPE85			5993802549	TD-ZAKOPP-114,3-TYPE85

Pre-assembly tools for ZAKO LP ring assembly

Type 85

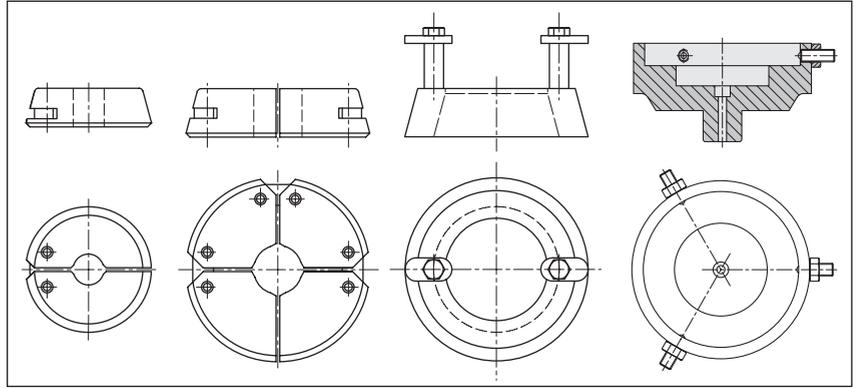

Flange size	Tube OD	Order-No.	Designation	Order-No.	Designation	Order-No.	Designation	Order-No.	Designation
NW			Clamping jaws		Clamping jaws		Spacer ring		Pressure plate
1 1/2"	48,3	5514941049	TD-ZAKOCJ-48,3-TYPE85			5514978100	TD-ZAKOSR-TYPE85	5993801849	TD-ZAKOPP-48,3/50-TYPE85
2"	60,3	5514941149	TD-ZAKOCJ-60,3-TYPE85			5514978100	TD-ZAKOSR-TYPE85	5993397949	TD-ZAKOPP-60,3-ID72,5-TYPE85
2 1/2"	60,3	5514941149	TD-ZAKOCJ-60,3-TYPE85			5514978100	TD-ZAKOSR-TYPE85	5993802949	TD-ZAKOPP-60,3-ID85,5-TYPE85
3"	76,1			5514941249	TD-ZAKOCJ-76,1-TYPE85			5993802249	TD-ZAKOPP-76,1/80-TYPE85
3 1/2"	88,9			5514941349	TD-ZAKOCJ-88,9-TYPE85			5993802449	TD-ZAKOPP-88,9/101,6-TYPE85
4"	114,3			5514940749	TD-ZAKOCJ-114,3-TYPE85			5993802849	TD-ZAKOPP-114,3-ID150,5-TYPE85

Pre-assembly tools VOSSForm^{SQR} (steel)

Type 100 / Type 100 Compact

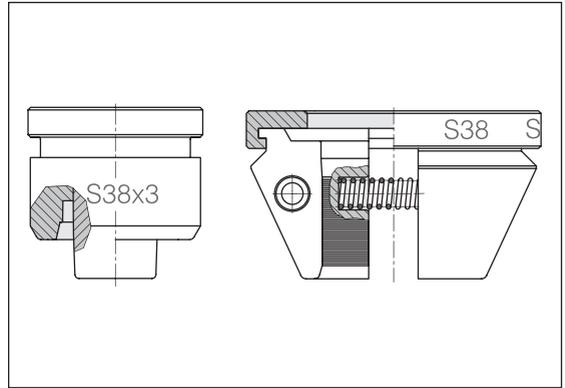

Tube OD	Order-No.	Designation	Tube OD	Order-No.	Designation
Forming head			Clamping jaws		
L/S 6 x 1	5993290690	TD-SQRFH-L/S6x1	L/S 6	5993090149	TD-SQRCJ-L/S6
L/S 6 x 1,5	5993290691	TD-SQRFH-L/S6x1,5	L/S 8	5993092949	TD-SQRCJ-L/S8
L/S 6 x 2	5993290692	TD-SQRFH-L/S6x2	L/S 10	5993093649	TD-SQRCJ-L/S10
L/S 8 x 1	5993293490	TD-SQRFH-L/S8x1	L/S 12	5993094349	TD-SQRCJ-L/S12
L/S 8 x 1,5	5993293491	TD-SQRFH-L/S8x1,5	L 15	5993096049	TD-SQRCJ-L15
L/S 8 x 2	5993293492	TD-SQRFH-L/S8x2	L 18	5993096749	TD-SQRCJ-L18
L/S 8 x 2,5	5993293493	TD-SQRFH-L/S8x2,5	L 22	5993097449	TD-SQRCJ-L22
L 10 x 1	5993294190	TD-SQRFH-L10x1	L 28	5993098149	TD-SQRCJ-L28
L 10 x 1,5	5993294191	TD-SQRFH-L10x1,5	L 35	5993098849	TD-SQRCJ-L35
L 10 x 2	5993294192	TD-SQRFH-L10x2	L 42	5993092249	TD-SQRCJ-L42
L 12 x 1	5993294890	TD-SQRFH-L12x1	S 14	5993099549	TD-SQRCJ-S14
L 12 x 1,5	5993294891	TD-SQRFH-L12x1,5	S 16	5993090849	TD-SQRCJ-S16
L 12 x 2	5993294892	TD-SQRFH-L12x2	S 20	5993091549	TD-SQRCJ-S20
L 15 x 1,5	5993296591	TD-SQRFH-L15x1,5	S 25	5993100349	TD-SQRCJ-S25
L 15 x 2	5993296592	TD-SQRFH-L15x2	S 30	5993101049	TD-SQRCJ-S30
L 15 x 2,5	5993296593	TD-SQRFH-L15x2,5	S 38	5993101749	TD-SQRCJ-S38
L 18 x 1,5	5993297291	TD-SQRFH-L18x1,5			
L 18 x 2	5993297292	TD-SQRFH-L18x2			
L 18 x 2,5	5993297293	TD-SQRFH-L18x2,5			
L 18 x 3	5993297294	TD-SQRFH-L18x3			
L 22 x 1,5	5993297991	TD-SQRFH-L22x1,5			
L 22 x 2	5993297992	TD-SQRFH-L22x2			
L 22 x 2,5	5993297993	TD-SQRFH-L22x2,5			
L 22 x 3	5993297994	TD-SQRFH-L22x3			
L 28 x 2	5993298692	TD-SQRFH-L28x2			
L 28 x 2,5	5993298693	TD-SQRFH-L28x2,5			
L 28 x 3	5993298694	TD-SQRFH-L28x3			
L 35 x 2	5993299392	TD-SQRFH-L35x2			
L 35 x 2,5	5993299393	TD-SQRFH-L35x2,5			
L 35 x 3	5993299394	TD-SQRFH-L35x3			
L 35 x 4	5993299396	TD-SQRFH-L35x4			
L 42 x 2	5993292792	TD-SQRFH-L42x2			

Pre-assembly tools VOSSForm^{SQR} (steel)

Type 100 / Type 100 Compact

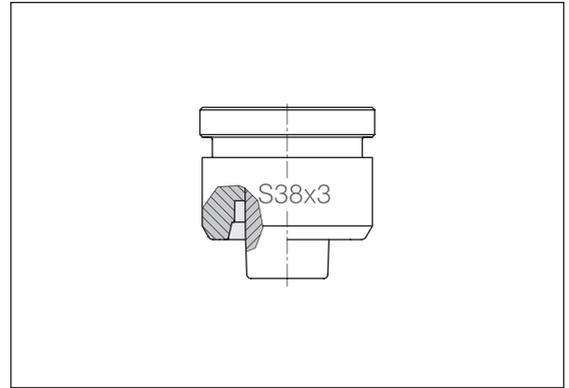

Tube OD	Order-No.	Designation
		Forming head
L 42 x 2,5	5993292793	TD-SQRFH-L42x2,5
L 42 x 3	5993292794	TD-SQRFH-L42x3
L 42 x 4	5993292796	TD-SQRFH-L42x4
S 10 x 1,5	5993295391	TD-SQRFH-S10x1,5
S 10 x 2	5993295392	TD-SQRFH-S10x2
S 10 x 2,5	5993295393	TD-SQRFH-S10x2,5
S 12 x 1,5	5993295891	TD-SQRFH-S12x1,5
S 12 x 2	5993295892	TD-SQRFH-S12x2
S 12 x 2,5	5993295893	TD-SQRFH-S12x2,5
S 12 x 3	5993295894	TD-SQRFH-S12x3
S 14 x 1,5	5993300191	TD-SQRFH-S14x1,5
S 14 x 2	5993300192	TD-SQRFH-S14x2
S 14 x 2,5	5993300193	TD-SQRFH-S14x2,5
S 14 x 3	5993300194	TD-SQRFH-S14x3
S 16 x 1,5	5993291391	TD-SQRFH-S16x1,5
S 16 x 2	5993291392	TD-SQRFH-S16x2
S 16 x 2,5	5993291393	TD-SQRFH-S16x2,5
S 16 x 3	5993291394	TD-SQRFH-S16x3
S 16 x 4	5993291396	TD-SQRFH-S16x4
S 20 x 2	5993292092	TD-SQRFH-S20x2
S 20 x 2,5	5993292093	TD-SQRFH-S20x2,5
S 20 x 3	5993292094	TD-SQRFH-S20x3
S 20 x 3,5	5993292095	TD-SQRFH-S20x3,5
S 20 x 4	5993292096	TD-SQRFH-S20x4
S 25 x 2	5993300892	TD-SQRFH-S25x2
S 25 x 2,5	5993300893	TD-SQRFH-S25x2,5
S 25 x 3	5993300894	TD-SQRFH-S25x3
S 25 x 4	5993300896	TD-SQRFH-S25x4
S 30 x 2	5993301592	TD-SQRFH-S30x2
S 30 x 2,5	5993301593	TD-SQRFH-S30x2,5
S 30 x 3	5993301594	TD-SQRFH-S30x3
S 30 x 4	5993301596	TD-SQRFH-S30x4

Pre-assembly tools VOSSForm^{SQR} (steel)

Type 100 / Type 100 Compact

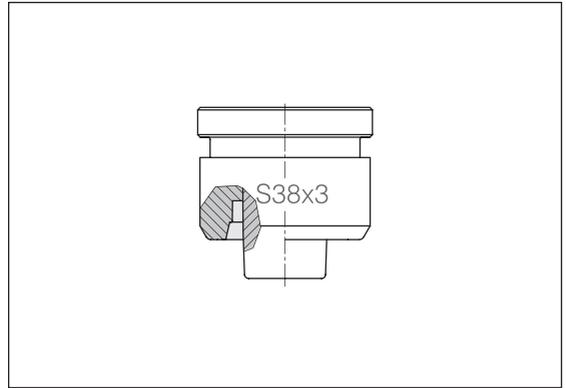

Tube OD	Order-No.	Designation Forming head
S 30 x 5	5993301597	TD-SQRFH-S30x5
S 30 x 6	5993301598	TD-SQRFH-S30x6
S 38 x 2,5	5993302293	TD-SQRFH-S38x2,5
S 38 x 3	5993302294	TD-SQRFH-S38x3
S 38 x 4	5993302296	TD-SQRFH-S38x4
S 38 x 5	5993302297	TD-SQRFH-S38x5
S 38 x 6	5993302298	TD-SQRFH-S38x6
S 38 x 7	5993302299	TD-SQRFH-S38x7

Pre-assembly tools VOSSForm^{SQRVA} (stainless steel)

Type 100 / Type 100 Compact

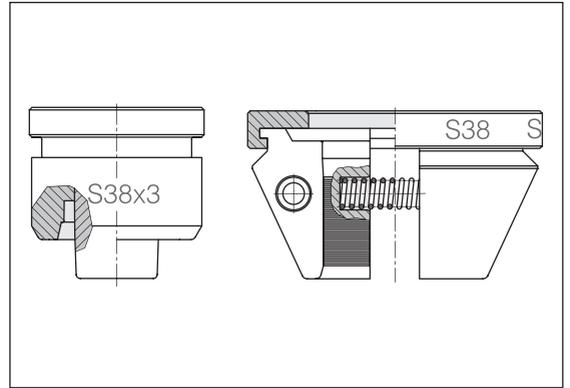

Tube OD	Order-No.	Designation	Tube OD	Order-No.	Designation
Forming head			Clamping jaws		
L/S 6 x 1	5993145000	TD-SQRFH-L/S6x1-SST	L/S 6	5993090149	TD-SQRCJ-L/S6
L/S 6 x 1,5	5993145100	TD-SQRFH-L/S6x1,5-SST	L/S 8	5993092949	TD-SQRCJ-L/S8
L/S 6 x 2	5993145200	TD-SQRFH-L/S6x2-SST	L/S 10	5993093649	TD-SQRCJ-L/S10
L/S 8 x 1	5993145300	TD-SQRFH-L/S8x1-SST	L/S 12	5993094349	TD-SQRCJ-L/S12
L/S 8 x 1,5	5993145400	TD-SQRFH-L/S8x1,5-SST	L 15	5993096049	TD-SQRCJ-L15
L/S 8 x 2	5993145500	TD-SQRFH-L/S8x2-SST	L 18	5993096749	TD-SQRCJ-L18
L/S 8 x 2,5	5993145600	TD-SQRFH-L/S8x2,5-SST	L 22	5993097449	TD-SQRCJ-L22
L 10 x 1	5993145700	TD-SQRFH-L10x1-SST	L 28	5993098149	TD-SQRCJ-L28
L 10 x 1,5	5993145800	TD-SQRFH-L10x1,5-SST	L 35	5993098849	TD-SQRCJ-L35
L 10 x 2	5993145900	TD-SQRFH-L10x2-SST	L 42	5993092249	TD-SQRCJ-L42
L 12 x 1	5993146000	TD-SQRFH-L12x1-SST	S 14	5993099549	TD-SQRCJ-S14
L 12 x 1,5	5993146100	TD-SQRFH-L12x1,5-SST	S 16	5993090849	TD-SQRCJ-S16
L 12 x 2	5993146200	TD-SQRFH-L12x2-SST	S 20	5993091549	TD-SQRCJ-S20
L 15 x 1,5	5993146300	TD-SQRFH-L15x1,5-SST	S 25	5993100349	TD-SQRCJ-S25
L 15 x 2	5993146400	TD-SQRFH-L15x2-SST	S 30	5993101049	TD-SQRCJ-S30
L 15 x 2,5	5993146500	TD-SQRFH-L15x2,5-SST	S 38	5993101749	TD-SQRCJ-S38
L 18 x 1,5	5993146600	TD-SQRFH-L18x1,5-SST			
L 18 x 2	5993146700	TD-SQRFH-L18x2-SST			
L 18 x 2,5	5993146800	TD-SQRFH-L18x2,5-SST			
L 18 x 3	5993146900	TD-SQRFH-L18x3-SST			
L 22 x 1,5	5993147000	TD-SQRFH-L22x1,5-SST			
L 22 x 2	5993147100	TD-SQRFH-L22x2-SST			
L 28 x 2	5993147200	TD-SQRFH-L28x2-SST			
L 28 x 2,5	5993147300	D-SQRFH-L28x2,5-SST			
L 28 x 3	5993147400	TD-SQRFH-L28x3-SST			
L 35 x 2	5993147500	TD-SQRFH-L35x2-SST			
L 35 x 2,5	5993147600	TD-SQRFH-L35x2,5-SST			
L 35 x 3	5993147700	TD-SQRFH-L35x3-SST			
L 42 x 2	5993147800	TD-SQRFH-L42x2-SST			
L 42 x 3	5993147900	TD-SQRFH-L42x3-SST			

Pre-assembly tools VOSSForm^{SQRVA} (stainless steel)

Type 100 / Type 100 Compact

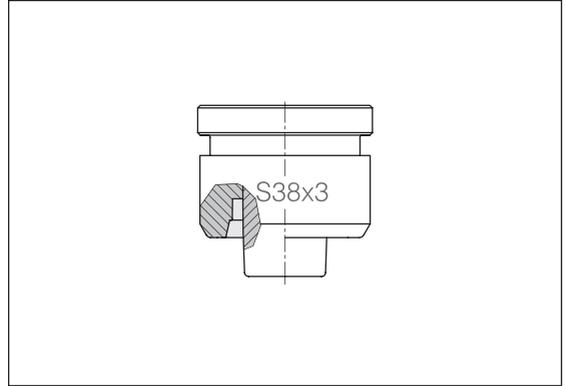

Tube OD	Order-No.	Designation
		Forming head
S 10 x 1,5	5993148000	TD-SQRFH-S10x1,5-SST
S 10 x 2	5993148100	TD-SQRFH-S10x2-SST
S 10 x 2,5	5993148200	TD-SQRFH-S10x2,5-SST
S 12 x 1,5	5993148300	TD-SQRFH-S12x1,5-SST
S 12 x 2	5993148400	TD-SQRFH-S12x2-SST
S 12 x 2,5	5993148500	TD-SQRFH-S12x2,5-SST
S 12 x 3	5993148600	TD-SQRFH-S12x3-SST
S 14 x 1,5	5993148700	TD-SQRFH-S14x1,5-SST
S 14 x 2	5993148800	TD-SQRFH-S14x2-SST
S 14 x 2,5	5993148900	TD-SQRFH-S14x2,5-SST
S 14 x 3	5993149000	TD-SQRFH-S14x3-SST
S 16 x 1,5	5993149100	TD-SQRFH-S16x1,5-SST
S 16 x 2	5993149200	TD-SQRFH-S16x2-SST
S 16 x 2,5	5993149300	TD-SQRFH-S16x2,5-SST
S 16 x 3	5993149400	TD-SQRFH-S16x3-SST
S 20 x 2	5993149500	TD-SQRFH-S20x2-SST
S 20 x 2,5	5993149600	TD-SQRFH-S20x2,5-SST
S 20 x 3	5993149700	TD-SQRFH-S20x3-SST
S 25 x 2	5993149800	TD-SQRFH-S25x2-SST
S 25 x 2,5	5993149900	TD-SQRFH-S25x2,5-SST
S 25 x 3	5993150000	TD-SQRFH-S25x3-SST
S 25 x 4	5993150100	TD-SQRFH-S25x4-SST
S 30 x 2,5	5993150200	TD-SQRFH-S30x2,5-SST
S 30 x 3	5993150300	TD-SQRFH-S30x3-SST
S 30 x 4	5993150400	TD-SQRFH-S30x4-SST
S 38 x 3	5993150500	TD-SQRFH-S38x3-SST
S 38 x 4	5993150600	TD-SQRFH-S38x4-SST
S 38 x 5	5993150700	TD-SQRFH-S38x5-SST

Assembly instructions

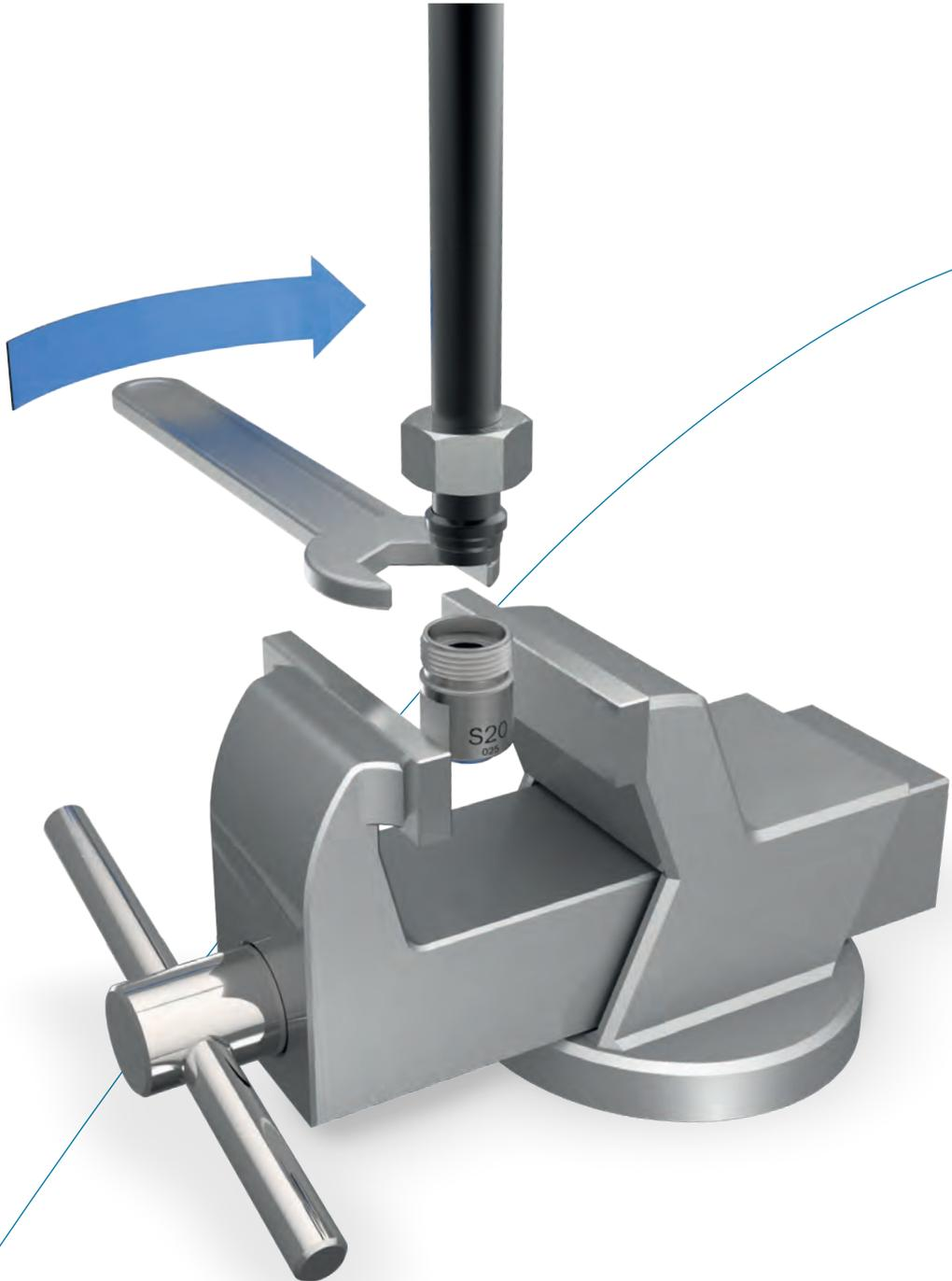

Content Type/Page

Important notes on VOSS
assembly instructions P.384

Assembly instructions *VOSSRing^M*
in conjunction with *VOSSRing* pre-
assembly stud P.386

Assembly instructions *VOSSRing^M*
in conjunction with universal pre-
assembly stud P.391

Assembly instructions for 2SVA
tube couplings P.395

Assembly instructions for ES-4
tube couplings P.400

Assembly instructions for ES-4VA
tube couplings P.405

Assembly instructions for
VOSSForm^{SQR} tube couplings P.410



Content	Type/Page
---------	-----------

Assembly instructions for VOSS <i>Form</i> ^{SQRVA} tube couplings	P.416
---	-------

Assembly instructions for BV-10 flared couplings	P.422
---	-------

Assembly instructions for taper (DKO) and weld nipple	P.427
--	-------

Assembly instructions for flange couplings / ZAKO / ZAKO LP	P.431
--	-------

Assembly instructions for flange couplings with cutting ring connection	P.438
---	-------

Assembly instructions for adjustable couplings as specified in ISO 6149 / 11926-1	P.441
---	-------

Assembly instructions for adjustable elbow couplings with lock nut	P.443
--	-------

Content	Type/Page
---------	-----------

Assembly instructions for 37° flare adapters	P.445
--	-------

Assembly instructions for tube blanking screws – sealed with PEFLEX moulded seal rings	P.451
--	-------

Important notes on VOSS assembly instructions

In order to ensure maximum performance and functional reliability of VOSS products, the respective assembly instructions, operating conditions and tube recommendations have to be adhered to.

We recommend that you use VOSS pre-assembly devices at all times. The use of pre-assembly devices is a strict requirement from tube sizes L18/S16 and larger! It is absolutely essential to follow the operating instructions for the respective pre-assembly device used.

Do not start with assembly until you are absolutely sure that you have understood the operating and assembly instructions for each VOSS pre-assembly device or machine, tool and product. Incorrect handling leads to risks regarding safety and leak-tightness and can result in failure of the entire connection.

It is impossible for the manufacturer to monitor whether the user is adhering to the operating and assembly instructions for individual pre-assembly devices or machines, tools and products, as well as what conditions prevail and what methods are used for installation, operation, application and maintenance of the individual products. Improper workmanship can lead to material damage, which in turn may pose a danger to life and limb. This means that VOSS Fluid GmbH can accept no responsibility or liability for loss, damage or costs incurred due to faulty installation, improper operation or incorrect application and maintenance or from any related issue. Failure to heed this warning will lead to loss of guarantee.

VOSS Fluid GmbH reserves the right to make changes or additions to the information provided without prior notification. Customers can obtain the latest version of the operating and assembly instructions upon request, or from our download area at: www.voss.net

General notes on VOSS assembly instructions

Make sure that all components, including the tubes, are clean before assembly is started and that they remain clean during the entire assembly process. Soiled components may lead to failure of the system.

Before starting assembly, make sure that you have carried out all preparatory work in accordance with the respective instructions.

Specifications concerning permissible steel tubes:

seamless, cold-drawn and normalized precision steel tubes as specified in DIN EN 10305-4, material E235+N, mat. no. 1.0308+N or E355, mat. no. 1.0580. The tubes must be ordered by specifying the outer diameter and the inner diameter.

Specifications concerning permissible stainless steel tubes:

seamless, cold-drawn and solution-annealed, scale-free stainless steel tubes in CFA or CFD delivery condition of dimensions and tolerances according to DIN EN 10305-1 and all other delivery conditions as specified in DIN EN 10216-5, material X6CrNiMoTi17-12-2, mat. no. 1.4571. The tubes must be ordered by specifying the outer diameter and the inner diameter.

The tubes should be prepared with the same thoroughness as pre-assembly and final assembly of the connection. Especially when using long tubes, check the end sections for damage or distortion.

We recommend that pre-assembled tubes which are not to be finally assembled yet should be fitted with protective caps.

Marking a stroke on the union nut and the tube makes it easier to achieve the correct number of turns when tightening the coupling.

Before starting to assemble VOSS components with elastomer seals, always check that:

- the nut and the seal surfaces are clean and undamaged and/or
- the elastomer sealing is clean and undamaged

Determining the tightening torque for screw couplings

The tightening torques specified in the catalogue apply under the following conditions:

- steel fittings with VOSS coat surface coating
- the specified nominal pressure ranges assume that the mating material has a tensile strength of $\geq 600 \text{ N/mm}^2$
- our recommendations on lubrication of the threaded studs are observed

If other values for strength, modulus of elasticity and friction-surface combinations are used, the user has to adapt the tightening torque empirically.

The recommended tightening torques have to be adhered to if the pressure range is to be fully utilized and the appropriate safety level is to be maintained.

The recommended tightening torques for the threads are given in the tables for the respective type of thread.

Explanation of symbols and other notes



Visual inspection



Turn until hand-tight or carry out another manual activity



Use the tool to tighten the coupling according to the instructions



Oil and lubricate at the point marked with an arrow

All dimensions in millimetres [mm]

Assembly Instructions VOSSRing^M tube couplings in conjunction with VOSSRing pre-assembly stud

1

Notes

Before starting assembly work please consider the general notes in the latest VOSS catalog and check that your assembly instructions are up to date!

These assembly instructions describe the manual mounting options provided in DIN 3859-2.

However, we always recommend assembly using VOSS pre-assembly devices and tools. Here the respective operating instructions must be observed.

To use the VOSSRing^M the use of specially developed VOSSRing pre-assembly mandrel is recommended. Only in this way can the patented stop function and the shortened 30° final assembly route be used.

Conventional VOSS pre-assembly mandrels can also be used. However, in this case separate installation instructions must be observed.

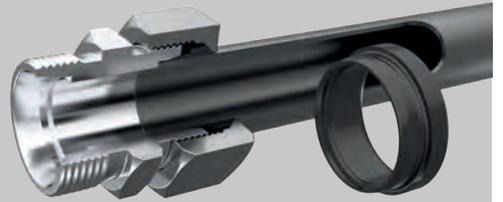

For use with steel and stainless steel tubes according to VOSS specification (see introduction assembly instructions).

Attention:

Please note the recommendation on the use of support sleeves for thin-walled steel pipes and soft tubes of non-ferrous metals and support sleeves of material 1.4571 for thin-walled stainless steel tubes.

2

Tube preparation

2.1 Minimum dimensions of the straight tube ends must be taken into account for determining the tube lengths.

Series	Tube OD [mm]	H [mm]	L [mm]
L	6/8	31	39
L	10/12	33	42
L	15	36	45
L	18	38	48
L	22/28	42	53
L	35/42	48	60

Series	Tube OD [mm]	H [mm]	L [mm]
S	6/8	35	44
S	10/12	37	47
S	14/16	43	54
S	20	50	63
S	25	54	68
S	30	58	72
S	38	65	82

With machine pre-assembly, the minimum lengths are contained in the respective operating instructions of the pre-assembly devices.

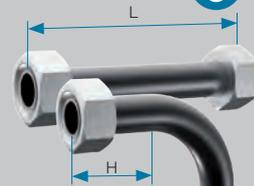

VOSSRing^M in conjunction with VOSSRing pre-assembly stud

2.2 Saw off tube at a right angle. An angular tolerance of $\pm 1^\circ$ is permissible. Do not use pipe cutters or abrasive cutting machines.

2.3 Slightly deburr tube ends inside and outside. Clean tube.

Attention:

Tubes cut crookedly or improperly deburred reduce service life and the tightness of the connection.

2.4 Assembly of VOSS reinforcement sleeves.

1a. Lightly coat the outer circumference of the steel sleeve with lubricant (e.g. mineral-oil based hydraulic oil HLP32). Then insert the sleeve into the tube up to the knurled section.

1b. Lightly coat the outer circumference of the stainless steel sleeve with assembly paste (e.g. assembly paste MPE). Then insert the sleeve into the tube up to the knurled section.

2. Use a hammer (plastic or hard rubber) to drive in the sleeve totally. In doing so, the knurled section is pressed against the inner wall of the tube and prevents the sleeve from being displaced or falling out.

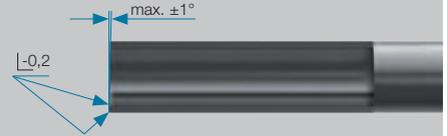

Sleeve inserted



Sleeve driven in

Series	Tube OD [mm]	Wall thickness [mm]						
		0.5	0.75	1	1.5	2	2.5	3
L	6	•	•					
L	8	•	•					
L	10	•	•					
L	12	•	•	•				
L	15	•	•	•				
L	18	•	•	•	•			
L	22	•	•	•	•	•		
L	28	•	•	•	•	•		
L	35	•	•	•	•	•	•	
L	42	•	•	•	•	•	•	
S	6	•	•					
S	8	•	•					
S	10	•	•					
S	12	•	•	•				
S	14	•	•	•				
S	16	•	•	•	•			
S	20	•	•	•	•	•		
S	25	•	•	•	•	•		
S	30	•	•	•	•	•	•	
S	38	•	•	•	•	•	•	•

VOSSRing^M in conjunction with VOSSRing pre-assembly stud

3

Assembly preparation

3.1 Lightly lubricate the thread, the cutting ring, the tube end and the taper of the coupling connecting piece and/or the manual pre-assembly mandrel (e.g. using mineral-oil based hydraulic oil HLP32 or, with stainless steel, assembly paste MPE).

3.2 Put the union nut and the VOSSRing^M on the tube end one after the other. The cutting edges of the VOSSRing^M point towards the tube end.

Attention:

Make sure that the VOSSRing^M is in the right position!

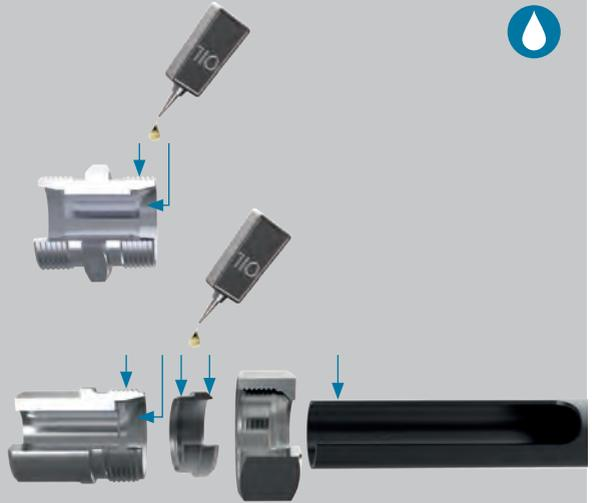

4

Pre-assembly

The VOSSRing^M can be pre-assembled directly in the coupling connecting piece or using the hardened VOSSRing pre-assembly mandrel.

VOSSRing^M pre-assembly mandrels for heavy-duty steel show no typical wear and have no inspection intervals. When the usage limits of the pre-assembly mandrel are reached, the front end breaks off, so that a replacement must be made.

Attention:

When mounting these directly in the coupling connecting piece, this may be used only once for pre-assembly!

All given assembly instructions must be strictly adhered to! Otherwise the coupling could leak or the tube may be torn out of the coupling!

4.1 Insert the tube end into the 24° taper as far as it will go and press on it. The tube must be held in as far as it can go during the assembly process in order to avoid faulty assembly.

4.2 Tighten the union nut until it is hand tight.

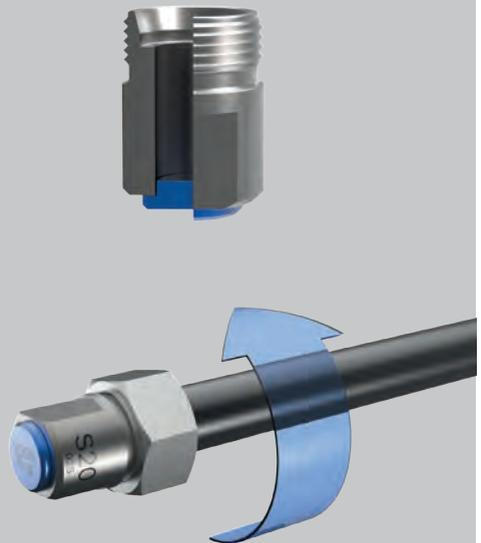

VOSSRing^M in conjunction with VOSSRing pre-assembly stud

4.3 Tighten the nut
1 1/2 turns with the wrench.

Notes:

In pre-assembly in the patented VOSSRing pre-assembly mandrel, the end of assembly is easily recognizable after about 1 1/2 turns thanks to the block stop installation or a noticeable force increase.

For assembly into the tube hold the coupling connecting piece in place with a wrench. For compliance with the specified number of turns marking lines are recommended on the union nut and tube.

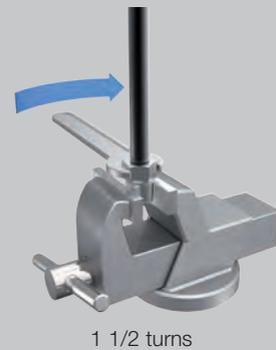
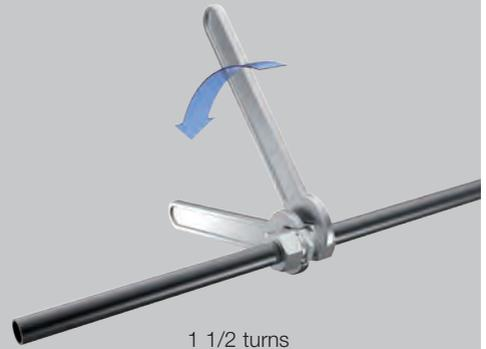

5

Assembly inspection

Loosen the nut and check the shoulder throw-up. The shoulder throw-up should cover the cutting-edge front face completely, i.e. cover approximately 100%. With thin-walled tubes and stainless steel tubes the shoulder throw-up has shown to be as markedly less.

In this position, it is still permissible for the cutting ring to turn on the tube. Any dirt must be removed.

Attention:

If not enough tube material has been raised, the procedure must be repeated using more force. The result must be rechecked.

Note:

We recommend the use of the VOSS gauge to check the correct axial position of the cutting ring.

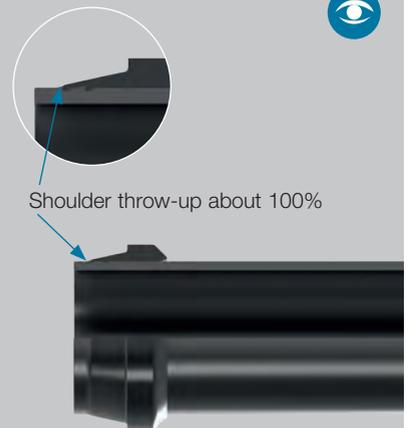

VOSSRing^M in conjunction with VOSSRing pre-assembly stud

6

Final assembly

6.1 Lightly lubricate the thread, the pre-assembled tube end and the taper of the coupling connecting piece easily with lubricant (e.g. using mineral-oil based hydraulic oil HLP32 or, with stainless steel, assembly paste MPE).

6.2 Carefully insert the pre-assembled tube end into the coupling connecting piece. Then tighten the union nut until it is hand tight.

Attention:

If the VOSSRing^M was pre-assembled in the coupling connecting piece, the same coupling connecting piece used for the direct assembly must be used again for the final assembly.

6.3 Tighten the union nut with a wrench until there is a noticeable force increase. As a result, the coupling components are elastically stressed and the state of assembly after pre-assembly is once again achieved.

6.4 Then tighten a further **30° final assembly route**. As a result of this, a lower final cut of the cutting ring is achieved and an absolute tightness guaranteed.

Attention:

When tightening up the coupling connecting piece for the final time, always hold it in wrench or clamp it in a vise.

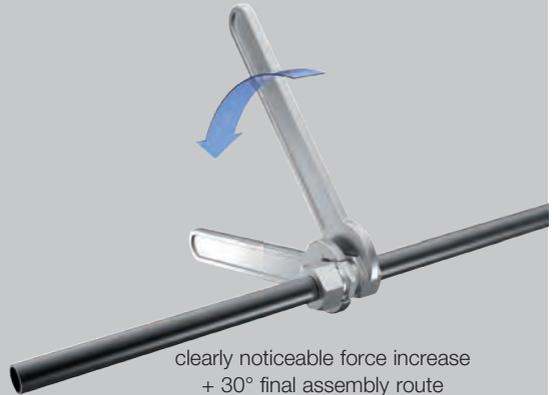

7

Repeat assembly

The repeated assembly is carried out identically to the final assembly.

7.1 Tighten the nut with a wrench until there is a noticeable force increase.

7.2 Then tighten a further 30° final assembly route.



Assembly instructions VOSSRing^M in conjunction with universal pre-assembly stud

1

Notes

These assembly instructions describe the pre-assembly of the VOSSRing^M in conjunction with the universal pre-assembly stud in steel or heavy duty steel.

However, to use the VOSSRing^M the use of specially developed VOSSRing pre-assembly stud is nevertheless recommended. Only in this way can the patented stop function and the shortened 30° final assembly route be used.

Before starting assembly work please consider the general notes in the latest VOSS catalog and check that your assembly instructions are up to date!

These assembly instructions describe the manual mounting options provided in DIN 3859-2.

However, we always recommend assembly using VOSS pre-assembly devices and tools. Here the respective operating instructions must be observed.



For use with steel and stainless steel tubes according to VOSS specification (see introduction assembly instructions).

Attention!

Please note the recommendation on the use of support sleeves for thin-walled steel tubes and soft tubes of non-ferrous metals and support sleeves of material 1.4571 for thin-walled stainless steel tubes.

2

Tube preparation

2.1 Minimum dimensions of the straight tube ends must be taken into account for determining the tube lengths.

Series	Tube OD [mm]	H [mm]	L [mm]
L	6/8	31	39
L	10/12	33	42
L	15	36	45
L	18	38	48
L	22/28	42	53
L	35/42	48	60

Series	Tube OD [mm]	H [mm]	L [mm]
S	6/8	35	44
S	10/12	37	47
S	14/16	43	54
S	20	50	63
S	25	54	68
S	30	58	72
S	38	65	82

With machine pre-assembly, the minimum lengths are contained in the respective operating instructions of the pre-assembly devices.

2.2 Saw off tube at a right angle. An angular tolerance of $\pm 1^\circ$ is permissible. Do not use tube cutters or abrasive cutting machines.



VOSSRing^M in conjunction with universal pre-assembly stud

2.3 Slightly deburr tube ends inside and outside.
Clean tube.

Attention!

Tubes cut crookedly or improperly deburred reduce service life and the tightness of the connection.

2.4 Assembly of VOSS reinforcement sleeves.

1a. Lightly coat the outer circumference of the steel sleeve with lubricant (e.g. mineral-oil based hydraulic oil HLP32). Then insert the sleeve into the tube up to the knurled section.

1b. Lightly coat the outer circumference of the stainless steel sleeve with assembly paste (e.g. assembly paste MPE). Then insert the sleeve into the tube up to the knurled section.

2. Use a hammer (plastic or hard rubber) to drive in the sleeve totally. In doing so, the knurled section is pressed against the inner wall of the tube and prevents the sleeve from being displaced or falling out.



Sleeve inserted



Sleeve driven in

Series	Tube-OD [mm]	Wall thickness [mm]						
		0.5	0.75	1	1.5	2	2.5	3
L	6	•	•					
L	8	•	•					
L	10	•	•					
L	12	•	•	•				
L	15	•	•	•				
L	18	•	•	•	•			
L	22	•	•	•	•	•		
L	28	•	•	•	•	•	•	
L	35	•	•	•	•	•	•	
L	42	•	•	•	•	•	•	
S	6	•	•					
S	8	•	•					
S	10	•	•					
S	12	•	•	•				
S	14	•	•	•				
S	16	•	•	•	•			
S	20	•	•	•	•	•		
S	25	•	•	•	•	•	•	
S	30	•	•	•	•	•	•	
S	38	•	•	•	•	•	•	•

3

Assembly preparation

3.1 Lightly lubricate the thread, the cutting ring, the tube end and the taper of the coupling connecting piece and/or the manual pre-assembly mandrel (e.g. using mineral-oil based hydraulic oil HLP32 or, with stainless steel, assembly paste MPE).

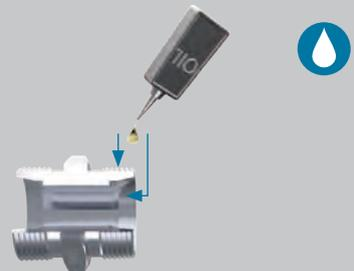

VOSSRing^M in conjunction with universal pre-assembly stud

3.2 Put the union nut and the VOSSRing^M on the tube end one after the other. The cutting edges of the VOSSRing^M point towards the tube end.

Attention!

Make sure that the VOSSRing^M is in the right position!

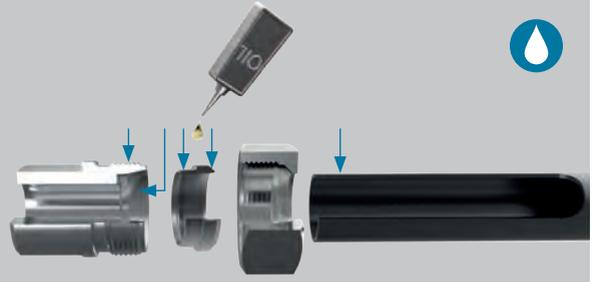

4

Pre-assembly

VOSSRing^M can be pre-assembled directly in the coupling connecting piece or with a hardened universal pre-assembly stud.

Hardened pre-assembly studs in steel are low-wear and enable uniform assembly results. Approximately every 50 pre-assemblies, accuracy to gauge must be checked.

Pre-assembly studs in heavy duty steel have up to 20x longer service life and a "wear inspection". If the usage limit is reached, the front end of the stud breaks off.

Attention!

Universal pre-assembly studs that are not true to gauge or damaged in the cone area must be replaced!

When mounting these directly in the coupling connecting piece, this may be used only once for pre-assembly!

All given assembly instructions must be strictly adhered to! Otherwise the coupling could leak or the tube may be torn out of the coupling!

4.1 Insert the tube end into the 24° taper as far as it will go and press on it. The tube must be held in as far as it can go during the assembly process in order to avoid faulty assembly.

4.2 Tighten the union nut until it is hand tight.

4.3 Tighten the union nut with a wrench to an outer tube.

- diameter of 18
1 1/2 turns
- to 20 mm.
1 1/4 turns

For assembly into the tube hold the coupling connecting piece in place with a wrench. For compliance with the specified number of turns marking lines are recommended on the union nut and tube.

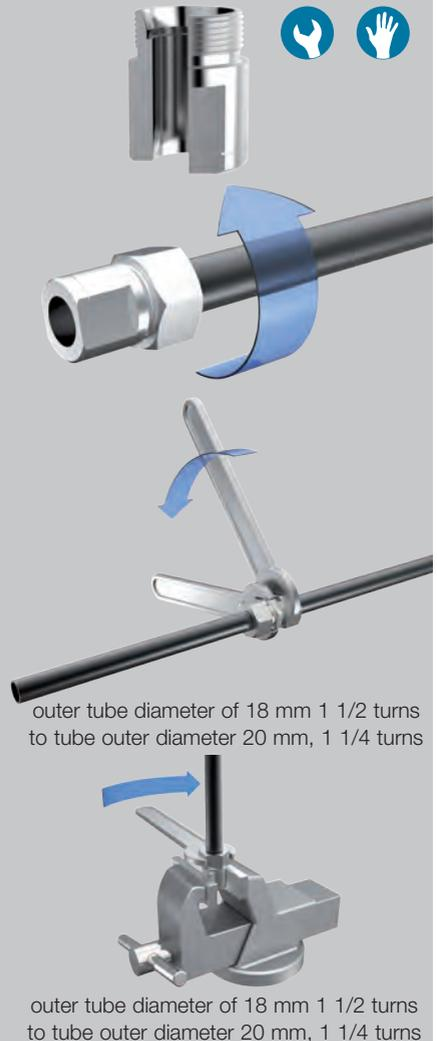

VOSSRing^M in conjunction with universal pre-assembly stud

5

Assembly inspection

Loosen the nut and check the shoulder throw-up. The shoulder throw-up should cover approximately 80 % of the cutting-edge front face. With thin-walled tubes and stainless steel tubes the shoulder throw-up has shown to be as markedly less.

In this position, it is still permissible for the cutting ring to turn on the tube. Any dirt must be removed.

Attention!

If not enough tube material has been raised, the procedure must be repeated using more force. The result must be rechecked.

Note:

We recommend the use of the VOSS gauge to check the correct axial position of the cutting ring.

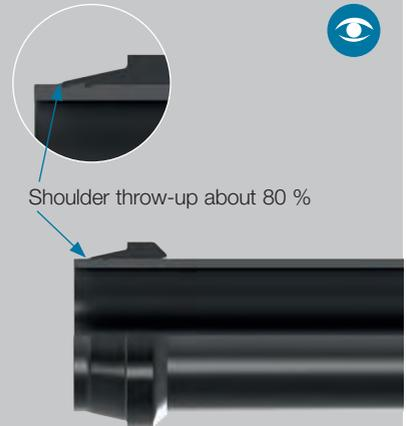

6

Final assembly

6.1 Lightly lubricate the thread, the pre-assembled tube end and the taper of the coupling connecting piece easily with lubricant (e.g. using mineral-oil based hydraulic oil HLP32 or, with stainless steel, assembly paste MPE).

6.2 Carefully insert the pre-assembled tube end into the coupling connecting piece. Then tighten the union nut until it is hand tight.

Attention!

If the VOSSRing^M was pre-assembled in the coupling connecting piece, the same coupling connecting piece used for the direct assembly must be used again for the final assembly.

6.3 Tighten the nut with a wrench until there is a noticeable force increase. As a result, the coupling components are elastically stressed.

Then tighten another 1/4 turn.

Attention!

When tightening up the coupling connecting piece for the final time, always hold it in wrench or clamp it in a vise.



7

Repeat assembly

For repeated assembly, the union nut is tightened with the same force as during the initial assembly.



Assembly instructions for 2SVA tube couplings

1 Notes

Before starting the assembly work, read the general notes in the latest VOSS catalogue and check that your assembly instructions are up to date

VOSS 2SVA cutting rings have to be pre-assembled in hardened tools.

These assembly instructions describe the pre-assembly in hardened pre-assembly studs.

We recommend that VOSS pre-assembly devices and tools are used for assembly at all times.

For use with stainless-steel tubes in accordance with VOSS specifications (see introduction to assembly instructions).

Attention!
Please note the recommendation on the use of tube supports made of material 1.4571 for thin-walled steel tubes.





2 Tube preparation

2.1 The minimum dimensions of the straight tube ends must be taken into account for determining the tube lengths.

Series	Tube OD [mm]	H [mm]	L [mm]
L	6/8	31	39
L	10/12	33	42
L	15	36	45
L	18	38	48
L	22/28	42	53
L	35/42	48	60

Series	Tube OD [mm]	H [mm]	L [mm]
S	6/8	35	44
S	10/12	37	47
S	14/16	43	54
S	20	50	63
S	25	54	68
S	30	58	72
S	38	65	82

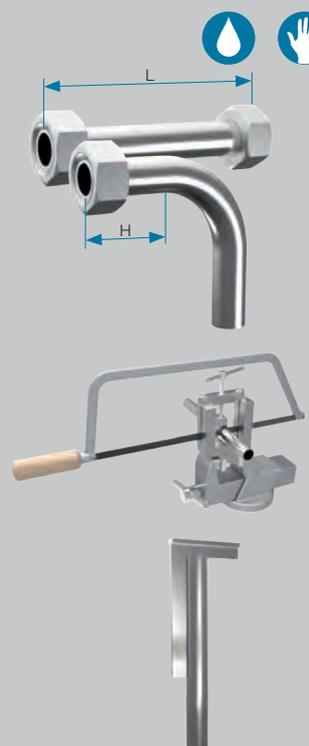
With machine pre-assembly, the minimum lengths are contained in the respective operating instructions of the pre-assembly devices.





2SVA

2.2 Saw tube off at right angles. An angle tolerance of $\pm 1^\circ$ is permissible. Do not use a rotary grinder or tube cutter.

2.3 Slightly deburr tube ends inside and outside. Clean the tube.

Attention!

If tubes are not cut off squarely or are not properly deburred, this may reduce the service life and leak-tightness of the couplings.

2.4 Assembly of VOSS reinforcing sleeves

1. Lubricate the outside surface the sleeve lightly using assembly paste (e.g. MPE assembly paste). Then insert the sleeve into the tube up to the knurled section.
2. Use a hammer (plastic or hard rubber) to drive the sleeve in totally. In doing so, the knurled section is pressed against the inner wall of the tube and prevents the sleeve from being displayed or falling out.

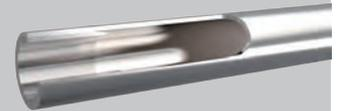

Series	Tube OD [mm]	Wall thickness [mm]						
		0.5	0.75	1	1.5	2	2.5	3
L	6	•	•					
L	8	•	•					
L	10	•	•					
L	12	•	•	•				
L	15	•	•	•				
L	18	•	•	•	•			
L	22	•	•	•	•	•		
L	28	•	•	•	•	•		
L	35	•	•	•	•	•	•	
L	42	•	•	•	•	•	•	
S	6	•	•					
S	8	•	•					
S	10	•	•					
S	12	•	•	•				
S	14	•	•	•				
S	16	•	•	•	•			
S	20	•	•	•	•	•		
S	25	•	•	•	•	•		
S	30	•	•	•	•	•	•	
S	38	•	•	•	•	•	•	•

2SVA

3

Assembly preparation

3.1 In order to carry out pre-assembly correctly, the thread of the coupling connecting piece, the tube end, the cutting ring, the union nut and the taper surfaces have to be lubricated with assembly paste (e.g. MPE assembly paste).

3.2 Put the union nut and the 2SVA cutting ring on the tube end.

Attention!

Make sure that the 2SVA cutting ring is in the right position.

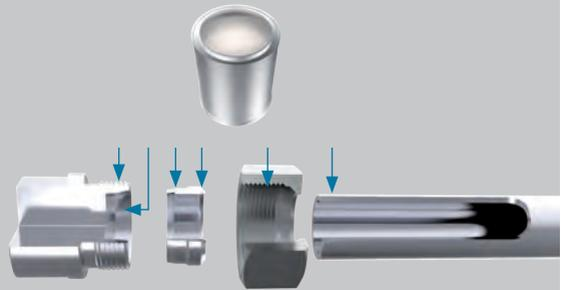

4

Assembly instructions

Hardened pre-assembly studs are wear-resistant, thus achieving consistent pre-assembly results. They have to be checked after approx. every 50 pre-assemblies for trueness of gauge.

Attention!

Pre-assembly studs that are not true to gauge or that are damaged in the taper section must be replaced immediately.

All specified assembly distances (number of turns) must be adhered to. Otherwise there is a danger that the coupling will leak or that the tube will tear out of the coupling.

4.1 Insert the tube end into the 24° taper as far as it will go and press on it. The tube must be held in as far as it will go during the entire assembly process in order to avoid faulty assembly.

4.2 Turn union nut until it is hand-tight.

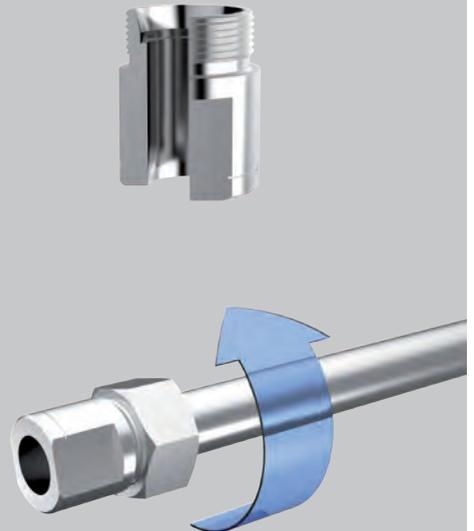

2SVA

4.3 Tighten union nut with approx. $1 \frac{1}{4}$ – $1 \frac{1}{2}$ turns.

Note:

Marking a stroke on the union nut and the tube makes it easier to achieve the correct number of turns.

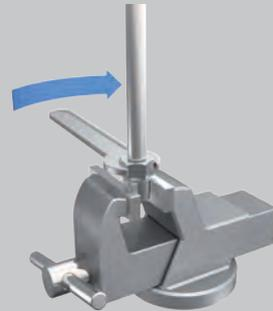

approx. $1 \frac{1}{4}$ – $1 \frac{1}{2}$ turns

5

Check results

Unscrew the union nut, check how much material has been pushed up. It is not possible to cut and raise as much material of stainless-steel tubes as on normal steel tubes. However, a certain amount of raised material must be visible.

On this position, it is still permissible for the cutting ring to turn on the tube.

Attention!

If not enough tube material has been raised, the procedure must be repeated using more force. The result must be rechecked.

Note:

We recommend the use of the VOSS gauge to check the correct axial position of the cutting ring.

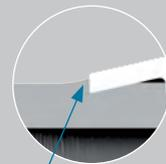

Visibly raised material



2SVA

6

Final assembly

6.1 Lubricate the thread, the pre-assembled tube end, the union nut and the taper lightly with assembly paste (e.g. MPE assembly paste).

6.2 Insert the pre-assembled tube end carefully into the coupling connecting piece. Then turn the union nut until it is hand-tight.

6.3 Use a spanner to tighten the union nut until there is a noticeable force increase.

6.4 Tighten up further by approximately **1/2 turns**.

Attention!

When finally tightening up the coupling connecting piece, always hold it in a spanner or clamp it in a vise.



7

Repeat assembly

For repeat assembly, the union nut must be tightened by using the same force as for the original assembly.



Assembly instructions for ES-4 tube couplings

1

Notes

Before starting the assembly work, read the general notes in the latest VOSS catalogue and check that your assembly instructions are up to date

These assembly instructions describe the possible assembly options provided for in the German standard DIN 3859 Part 2.

We recommend that VOSS pre-assembly devices and tools are used for assembly at all times.

For use with steel tubes in accordance with VOSS specifications (see introduction to assembly instructions).

Attention!

Please note the recommendation on the use of tube supports for thin-walled steel tubes and soft tubes made of non-ferrous metals.

This cutting ring is not suitable for stainless-steel tube assemblies. For these, cutting rings of types VOSSRing^M, 2SVA or ES-4VA must be used!



2

Tube preparation

2.1 The minimum dimensions of the straight tube ends must be taken into account for determining the tube lengths.

Series	Tube OD [mm]	H [mm]	L [mm]
L	6/8	31	39
L	10/12	33	42
L	15	36	45
L	18	38	48
L	22/28	42	53
L	35/42	48	60

Series	Tube OD [mm]	H [mm]	L [mm]
S	6/8	35	44
S	10/12	37	47
S	14/16	43	54
S	20	50	63
S	25	54	68
S	30	58	72
S	38	65	82

With machine pre-assembly, the minimum lengths are contained in the respective operating instructions of the pre-assembly devices.



ES-4

2.2 Saw tube off at right angles. An angle tolerance of $\pm 1^\circ$ is permissible. Do not use a rotary grinder or tube cutter.

2.3 Slightly deburr tube ends inside and outside. Clean the tube.

Attention!

If tubes are not cut off squarely or are not properly deburred, this may reduce the service life and leak-tightness of the couplings. Burrs on the tube outer diameter can damage the inner O-ring.

2.4 Assembly of VOSS reinforcing sleeves

1. Lubricate the outside surface of the sleeve lightly (e.g. using mineral-oil based hydraulic fluid HLP32). Then insert the sleeve into the tube up to the knurled section.
2. Use a hammer (plastic or hard rubber) to drive the sleeve in totally. In doing so, the knurled section is pressed against the inner wall of the tube and prevents the sleeve from being displaced or from falling out.

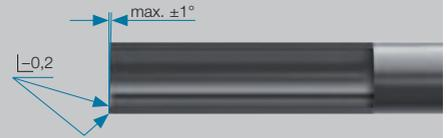

Series	Tube OD [mm]	Wall thickness [mm]						
		0.5	0.75	1	1.5	2	2.5	3
L	6	•	•					
L	8	•	•					
L	10	•	•					
L	12	•	•	•				
L	15	•	•	•				
L	18	•	•	•	•			
L	22	•	•	•	•	•		
L	28	•	•	•	•	•		
L	35	•	•	•	•	•	•	
L	42	•	•	•	•	•	•	
S	6	•	•					
S	8	•	•					
S	10	•	•					
S	12	•	•	•				
S	14	•	•	•				
S	16	•	•	•	•			
S	20	•	•	•	•	•		
S	25	•	•	•	•	•		
S	30	•	•	•	•	•	•	
S	38	•	•	•	•	•	•	•

ES-4

3

Assembly preparation

3.1 Lubricate the thread, the cutting ring, the tube end and the taper of the coupling connecting piece and/or of the manual pre-assembly stud lightly (e.g. using mineral-oil based hydraulic fluid HLP32).

Wetting the tube end with lubricant makes it easier to push the ES-4 cutting ring onto the tube.

3.2 Put the union nut and the ES-4 cutting ring on the tube end, one after the other. The cutting edges of the ES-4 cutting ring point towards the tube end.

Attention!

Make sure that the ES-4 cutting ring is in the right position.

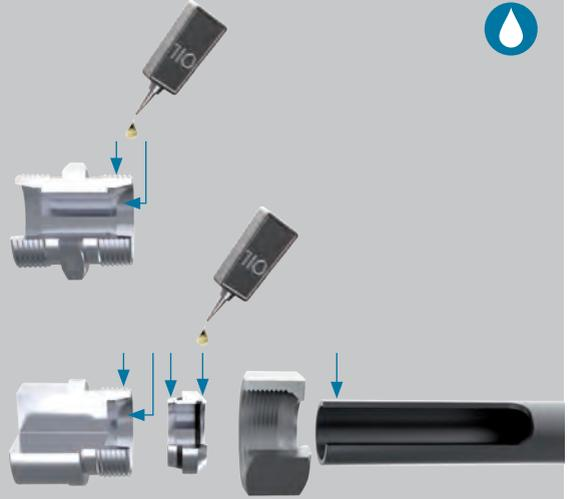

4

Assembly instructions

VOSS ES-4 cutting rings can be pre-assembled directly in the coupling connecting piece or using a hardened pre-assembly die.

Hardened pre-assembly dies are wear-resistant, thus achieving consistent pre-assembly results. They have to be checked after approx. every 50 pre-assemblies for trueness of gauge.

Attention!

Pre-assembly studs that are not true to gauge or that are damaged in the tapered section must be replaced on all accounts. When mounting them directly in the coupling connecting piece, this may be used only once for pre-assembly.

All specified assembly distances must be adhered to. Otherwise there is a danger that the coupling will leak or that the tube will tear out of the coupling.

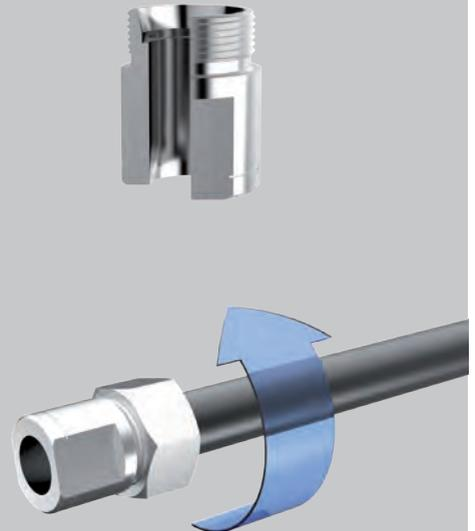

ES-4

4.1 Insert the tube end into the 24° taper as far as it will go and press on it. The tube must be held in as far as it will go during the entire assembly process in order to avoid faulty assembly.

4.2 Turn the union nut until it is hand-tight.

4.3 Tighten the union nut by approx. **1 1/4 turns** (min. 1 to max. 1 1/2 turns). This pushes the ES-4 cutting ring against the end face of the stud.

Notes:

When installing couplings in piping systems, always hold the coupling connecting piece in a spanner. Marking a stroke on the union nut and the tube makes it easier to achieve the correct number of turns.



5

Check results

5.1 Loosen the nut and check the shoulder throw-up and the moulded seal. The shoulder throw-up should cover approximate 80 % of the cutting-edge front face.

In this position, it is still permissible for the cutting ring to turn on the tube.

Attention!

The moulded seal must be undamaged. Remove possible soiling and replace the moulded seal if necessary.

If an inadequate amount of material is raised, repeat assembly with a higher torque. The results must be re-checked!

Note:

We recommend the use of the VOSS gauge to check the correct axial position of the cutting ring.

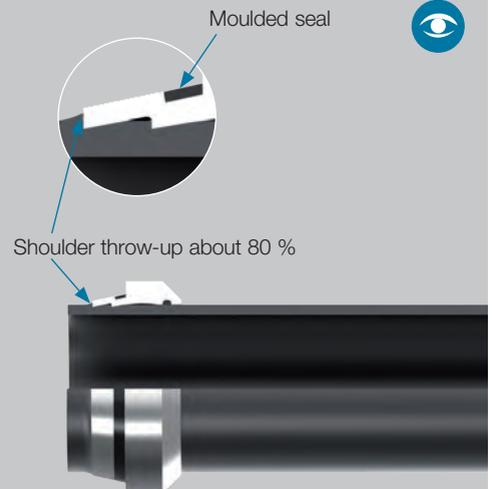

6

Final assembly

6.1 Lubricate the thread, the pre-assembled tube end and the taper of the coupling connecting piece lightly (e.g. using mineral-oil based hydraulic fluid HLP32).

6.2 Insert the pre-assembled tube end carefully into the coupling connecting piece, making sure that the moulded seal is not damaged and is seated in the seal groove correctly. Then turn the union nut until it is hand-tight.

Attention!

If the cutting ring was pre-assembled in the coupling connecting piece, the same coupling connecting piece used to pre-assemble the tube and cutting ring must be used again for final assembly.

6.3 Use a spanner to tighten the union nut until there is a noticeable force increase.

6.4 Tighten up further by approximately **1/4 turns**.

Attention!

When finally tightening up the coupling connecting piece, always hold it in a spanner or clamp it in a vise.



7

Repeat assembly

7.1 Each time the tube coupling is unscrewed, the moulded seal must be checked for damage and replaced if necessary.

7.2 For repeat assembly, the union nut must be tightened again with the same amount of force as during initial assembly.



Assembly instructions for ES-4VA tube couplings

1 Notes

Before starting the assembly work, read the general notes in the latest VOSS catalogue and check that your assembly instructions are up to date.

Toughened tools must be used to pre-assemble ES-4VA cutting rings.

These assembly instructions describe the pre-assembly in hardened pre-assembly studs.

We recommend that VOSS pre-assembly devices and tools are used for assembly at all times.

For use with stainless-steel tubes in accordance with VOSS specifications (see introduction to assembly instructions).

Attention!
Please note the recommendation on the use of tube supports made of material 1.4571 for thin-walled steel tubes.



2 Tube preparation

2.1 The minimum dimensions of the straight tube ends must be taken into account for determining the tube lengths.

Series	Tube OD [mm]	H [mm]	L [mm]
L	6/8	31	39
L	10/12	33	42
L	15	36	45
L	18	38	48
L	22/28	42	53
L	35/42	48	60

Series	Tube OD [mm]	H [mm]	L [mm]
S	6/8	35	44
S	10/12	37	47
S	14/16	43	54
S	20	50	63
S	25	54	68
S	30	58	72
S	38	65	82

With machine pre-assembly, the minimum lengths are contained in the respective operating instructions of the pre-assembly devices.



ES-4VA

2.2 Saw tube off at right angles. An angle tolerance of $\pm 1^\circ$ is permissible. Do not use a rotary grinder or tube.

2.3 Slightly deburr tube ends inside and outside. Clean the tube.

Attention!

If tubes are not cut off squarely or are not properly deburred, this may reduce the service life and leak-tightness of the couplings.

2.4 Assembly of VOSS reinforcing sleeves

1. Lubricate the outside surface of the sleeve lightly using assembly paste (e.g. MPE assembly paste). Then insert the sleeve into the tube up to the knurled section.
2. Use a hammer (plastic or hard rubber) to drive the sleeve in totally. In doing so, the knurled section is pressed against the inner wall of the tube and prevents the sleeve from being displaced or falling out.

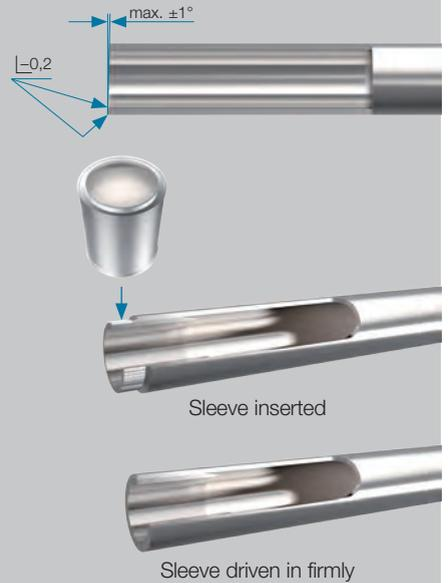

Series	Tube OD [mm]	Wall thickness [mm]						
		0.5	0.75	1	1.5	2	2.5	3
L	6	•	•					
L	8	•	•					
L	10	•	•					
L	12	•	•	•				
L	15	•	•	•				
L	18	•	•	•	•			
L	22	•	•	•	•	•		
L	28	•	•	•	•	•		
L	35	•	•	•	•	•	•	
L	42	•	•	•	•	•	•	
S	6	•	•					
S	8	•	•					
S	10	•	•					
S	12	•	•	•				
S	14	•	•	•				
S	16	•	•	•	•			
S	20	•	•	•	•	•		
S	25	•	•	•	•	•		
S	30	•	•	•	•	•	•	
S	38	•	•	•	•	•	•	•

ES-4VA

3

Assembly preparation



3.1 To ensure correct pre-assembly, lubricate the pre-assembly stud, tube end, cutting ring, union nut and the cone surface with assembly paste (e.g. MPE assembly paste).

3.2 Push the union nut and the ES-4VA cutting ring onto the tube end.

Attention!

Make sure that the ES-4VA cutting ring is in the right position.

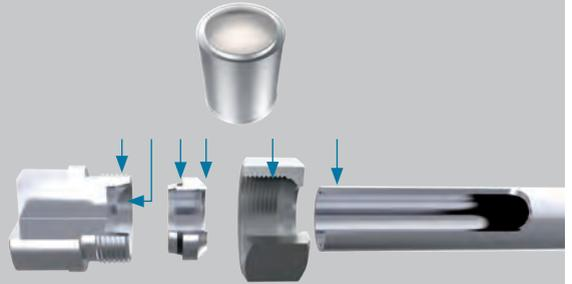

4

Assembly instructions



Hardened pre-assembly studs are wear-resistant, thus achieving consistent pre-assembly results. They have to be checked after approx. every 50 pre-assemblies for trueness of gauge.

Attention!

Pre-assembly studs that are not true to gauge or that are damaged in the taper section must be replaced immediately. All specified assembly distances must be adhered to. Otherwise there is a danger that the coupling will leak or that the tube will tear out of the coupling.

4.1 Insert the tube end into the 24° taper as far as it will go and press on it. The tube must be held in as far as it will go during the entire assembly process in order to avoid faulty assembly.

4.2 Push the pre-assembled tube end into the taper of the hardened manual pre-assembly die and turn the union nut until it is hand-tight.

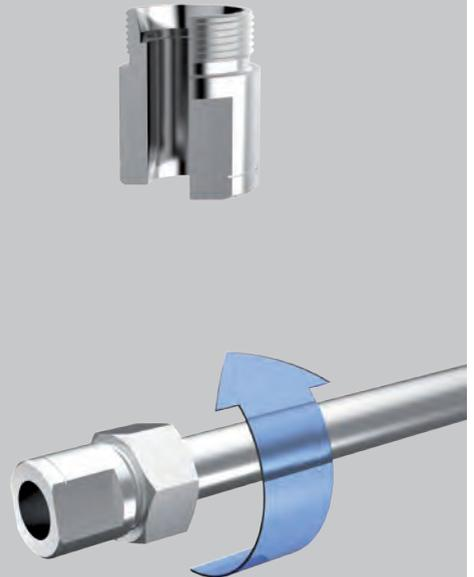

7

ES-4VA

4.3 Tighten union nut with approx. **1 1/4 turns** (min. 1 to max. 1 1/2 turns). This pushes the ES-4 cutting ring against the end face of the stud.

Note:

Marking a stroke on the union nut and the tube makes it easier to achieve the correct number of turns.

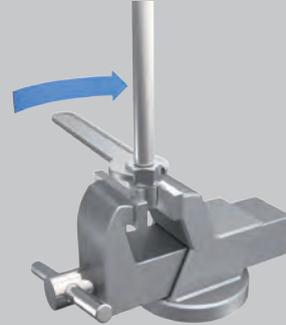

approx. 1 1/4 turns

5

Check results

5.1 Unscrew the union nut, check the moulded seal, gap width and how much material has been pushed up. It is not possible to cut and raise as much material of stainless-steel tubes as on normal steel tubes. However, a certain amount of raised material must be visible.

In this position, it is still permissible for the cutting ring to turn on the tube.

Attention!

The moulded seal must be undamaged. Remove possible soiling and replace the moulded seal if necessary.

If an inadequate amount of material is raised, repeat assembly with a higher torque. The results must be re-checked!

Note:

We recommend the use of the VOSS gauge to check the correct axial position of the cutting ring.

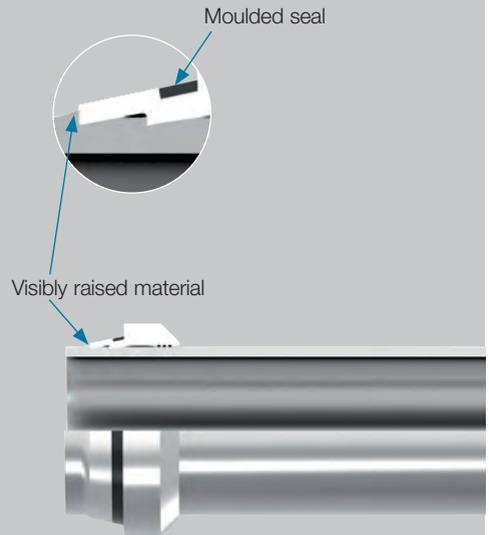

ES-4VA

6

Final assembly

6.1 Lubricate the thread, the pre-assembled tube end, the union nut and the taper lightly with assembly paste (e.g. MPE assembly paste).

6.2 Insert the pre-assembled tube end carefully into the coupling connecting piece. When fitting the parts together, take care not to damage the moulded seal and ensure that it is seated in the seal groove correctly. Then turn the union nut until it is hand-tight.

6.3 Use a spanner to tighten the union nut until there is a noticeable force increase.

6.4 Tighten up further by approximately **1/4 turns**.

Attention!

When finally tightening up the coupling connecting piece, always hold it in a spanner or clamp it in a vise.



7

Repeat assembly

7.1 Each time the tube coupling is unscrewed, the moulded seal must be checked for damage and replaced if necessary.

7.2 For repeat assembly, the union nut must be tightened using the same force as for the original assembly.

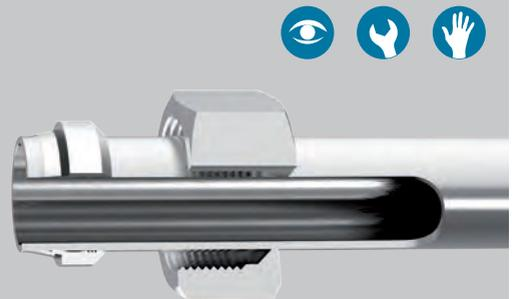

7

Assembly instructions for VOSSForm^{SQR} tube couplings

1

Notes

Before starting the assembly work, read and observe the general notes in the up-to-date VOSS catalogue and check that your assembly instructions are up to date.

These assembly instructions describe the tube forming and the final assembly of VOSSForm^{SQR}.

These assembly instructions are not a substitute for the detailed operating instructions of the forming device used. They only describe the basic tube preparation, forming and final assembly steps.



2

Tube preparation

2.1 When determining the tube lengths to be used, dimensions L1 and L2 have to be taken into consideration. The forming process compresses the tube and shortens it by the length L1.

In addition, the minimum lengths A1, A2 and B1, B2 required for clamping the tube ends have to be taken into consideration.

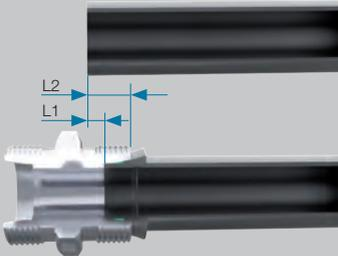

Height of the completely assembled VOSSForm^{SQR} connection.

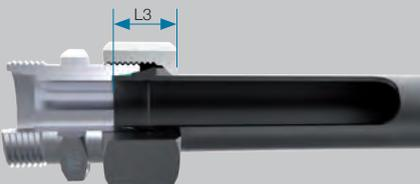

Series	Tube OD [mm]	s [mm]	L1 [mm]	L2 [mm]	L3 approx. [mm]	A1 [mm]		A2 [mm]		B1 [mm]	B2 [mm]
						$\alpha \leq 45^\circ$	$\alpha \leq 90^\circ$	$\alpha \leq 45^\circ$	$\alpha \leq 90^\circ$		
L	6	1	5.6	12.6	15.5	60	69	47	56	82	56
		1.5	6.0	13.0	16.0						
		2	5.3	12.3	16.0						
L	8	1	5.0	12.0	15.5	60	64	47	51	82	56
		1.5	5.7	12.7	16.0						
		2	5.2	12.2	16.0						
L	10	1	5.2	12.2	15.5	60	60	47	47	83	57
		1.5	5.8	12.8	16.0						
		2	5.1	12.1	16.0						
L	12	1	5.1	12.1	15.5	60	60	47	47	83	57
		1.5	5.8	12.8	16.0						
		2	4.9	11.9	16.0						
L	15	1.5	6.0	13.0	17.5	70	70	56	56	96	68
		2	5.6	12.6	17.5						
		2.5	5.3	12.3	17.5						
L	18	1.5	5.9	13.4	18.5	75	75	61	61	101	73
		2	5.3	12.8	18.5						
		2.5	5.1	12.6	18.5						
		3	5.1	12.6	18.5						
L	22	1.5	6.5	14.0	20.0	85	85	70	70	113	83
		2	5.6	13.1	20.0						
		2.5	5.4	12.9	20.0						
		3	5.3	12.8	20.0						
L	28	2	5.6	13.1	20.0	93	93	79	79	120	92
		2.5	5.4	12.9	20.0						
		3	5.5	13.0	20.0						
L	35	2	7.6	18.1	24.0	107	107	87	87	142	102
		2.5	7.0	17.5	24.0						
		3	7.5	18.0	25.0						
		4	7.2	17.7	25.0						
L	42	2	7.6	18.6	24.5	117	117	97	97	152	112
		2.5	7.0	18.0	24.5						
		3	7.4	18.4	25.5						
		4	7.0	18.0	25.5						

Minimum lengths for clamping in straight tubes.

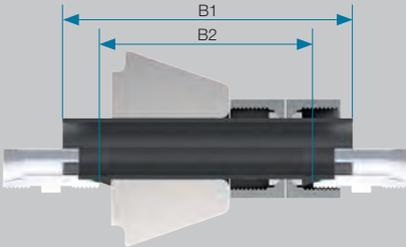

Minimum lengths for clamping in curved tubes (R ≥ 3x Tube OD).

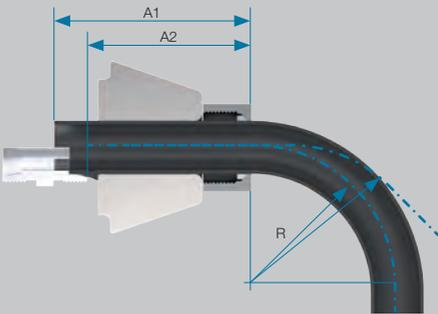

Series	Tube OD [mm]	s [mm]	L1 [mm]	L2 [mm]	L3 approx. [mm]	A1 [mm]		A2 [mm]		B1 [mm]	B2 [mm]
						R ≥ 3x DN	α ≤ 90°	R ≥ 3x DN	α ≤ 90°		
S	6	1	5.6	12.6	16.0	62	69	49	56	85	59
		1.5	6.0	13.0	16.5						
		2	5.3	12.3	16.5						
S	8	1	5.0	12.0	16.0	62	64	49	51	85	59
		1.5	5.7	12.7	16.5						
		2	5.2	12.2	16.5						
		2.5	4.4	11.4	16.5						
S	10	1.5	6.5	14.0	18.5	64	64	50	50	90	62
		2	5.9	13.4	18.5						
		2.5	5.2	12.7	18.5						
S	12	1.5	6.4	13.9	18.5	64	64	50	50	90	62
		2	5.7	13.2	18.5						
		2.5	5.2	12.7	18.5						
		3	4.9	12.4	18.5						
S	14	1.5	6.7	14.7	20.5	72	72	57	57	101	71
		2	6.3	14.3	20.5						
		2.5	5.8	13.8	20.5						
		3	5.7	13.7	20.5						
S	16	1.5	6.9	15.4	21.0	77	77	61	61	107	75
		2	6.1	14.6	21.0						
		2.5	5.7	14.2	21.0						
		3	5.5	14.0	21.0						
		4	5.2	13.7	21.5						
S	20	2	8.1	18.6	25.0	88	88	69	69	122	84
		2.5	7.2	17.7	25.0						
		3	6.8	17.3	25.0						
		3.5	6.6	17.1	25.0						
		4	6.4	16.9	25.0						
S	25	2	7.7	19.7	28.0	103	103	82	82	140	98
		2.5	7.3	19.3	28.0						
		3	7.0	19.0	28.0						
		4	6.6	18.6	28.0						
S	30	2	7.9	21.4	30.5	114	114	92	92	155	111
		2.5	7.3	20.8	30.5						
		3	8.1	21.6	31.5						
		4	7.6	21.1	31.5						
		5	7.3	20.8	31.5						
		6	7.0	20.5	32.0						
S	38	2.5	10.4	26.4	34.5	134	134	108	108	180	128
		3	9.1	25.1	34.5						
		4	9.2	25.2	35.5						
		5	9.1	25.1	35.5						
		6	9.0	25.0	35.5						
		7	9.0	25.0	36.0						

2.2 Cut tubes at right angles. An angle tolerance of $\pm 1^\circ$ is permissible. Do not use tube cutters or angle grinders to cut tubes.

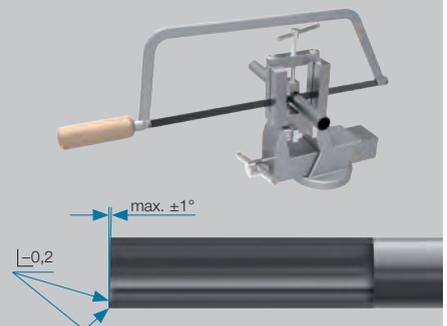

2.3 Slightly deburr tube ends inside and outside.
Clean the tube.

Attention!

Burrs on the outer and inner edges of the tube end can impair the forming process. Tubes which are not cut off squarely and correctly deburred reduce the service life and leak-tightness of the couplings.



3

Lubricating tools and steel tubes

After every tool change and after roughly 100 forming procedures, the outer surfaces of the clamping jaws at the tapered section should be lightly lubricated using hydraulic fluid or a non-resinous lubricant containing MoS₂.

Attention!

Ensure that no oil is applied to the teeth of the clamping jaw, otherwise the gripping function may be impaired.

Lubricating phosphate-treated steel tubes:

in order to reduce tool wear, on every tenth tube being processed, apply a thin film of hydraulic fluid to the internal and external surfaces of the tube section to be formed.

Lubricating zinc-plated steel tubes:

in order to reduce tool wear, on every tenth tube being processed, apply a thin film of hydraulic fluid to the internal and external surfaces of the tube section to be formed.

Attention!

If the lubricant film on the outer perimeter of the tubing is too thick, it will be trapped by the forming process and lead to inaccurate contours.

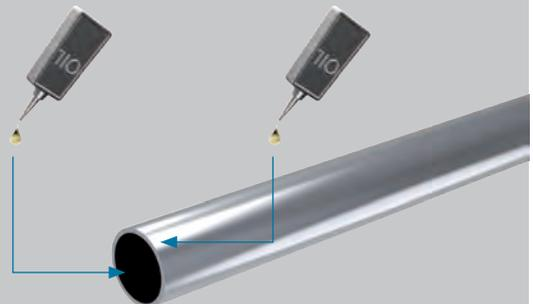
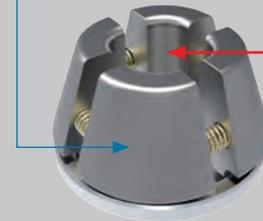

VOSSForm^{SQR}

4

Notes on tube forming

4.1 Prepare the tube forming device as described in the operating instructions and insert the tools.

4.2 Push the SQR-function nut onto the prepared tube end.

4.3 Form the tube as described in the operating instructions.



5

Check the results

It is adequate to visually inspect the quality of the three characteristic VOSSForm^{SQR} features.

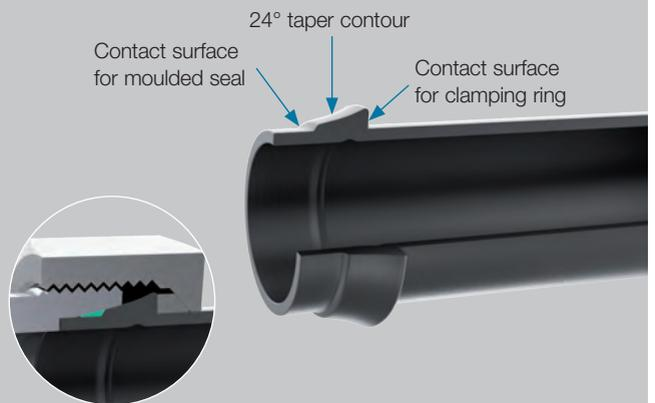

6

Final assembly

6.1 Install the moulded seal, ensuring that it is not twisted or damaged.

Push the pre-assembled tube end straight into the taper of the coupling connecting piece.

6.2 Lubricate the threads, the formed tube end and the moulded seal lightly (e.g. using mineral-oil based hydraulic fluid HLP32).

6.3 Turn union nut until it is hand-tight.

To achieve the final tightening torque, turn the SQR special function nut by approx. **1/2 to 3/4 of a turn**.

If the coupling is being installed on an already-installed piping system, hold the coupling connecting piece with a spanner when tightening the coupling.

Marking a stroke on the SQR special function nut and the tube makes it easier to achieve the correct number of turns when tightening the coupling.

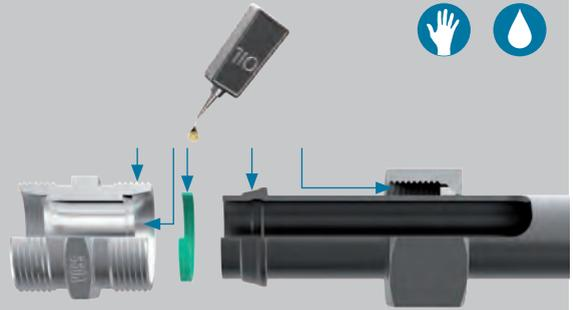

7

Re-assembly of couplings

7.1 Every time the coupling is taken apart, the moulded seal must be checked for damage and, if necessary, replaced.

7.2 For the second and all ensuing re-assembly processes, the SQR-function nut must be tightened by only **1/4 to 1/2 turns** after it has been hand-tightened.

Attention!

Fore re-assembling the coupling, the 24° taper contour, the moulded seal contact surfaces and the clamping ring must be checked for damage (see 5: Checking results).

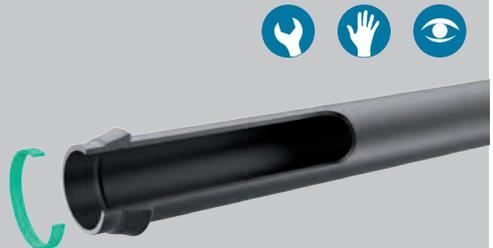

8

Tightening torques

8.1 As an alternative to achieving pre-assembly and final assembly states by distance dependent assembly, the tightening torques can be applied directly. The stated tightening torques are guideline values which have been determined under the following conditions:

- tube specifications as given in the general notes
- VOSS coat surface finish on all coupling components, and additional wax coating on the SQR-function nut.

Series	Tube OD [mm]	Tightening torque in Nm \pm 5 %
L	6	20
L	8	30
L	10	40
L	12	50
L	15	70
L	18	90
L	22	120
L	28	160
L	35	250
L	42	380
S	6	25
S	8	40
S	10	50
S	12	60
S	14	75
S	16	85
S	20	140
S	25	190
S	30	270
S	38	400

Assembly instructions for VOSSForm^{SQR}VA tube couplings

1

Notes

Before starting the assembly work, read and observe the general notes in the up-to-date VOSS catalogue and check that your assembly instructions are up to date.

These assembly instructions describe the tube forming and the final assembly of VOSSForm^{SQR}VA.

These assembly instructions are not a substitute for the detailed operating instructions of the forming device used. They only describe the basic tube preparation, forming and final assembly steps.

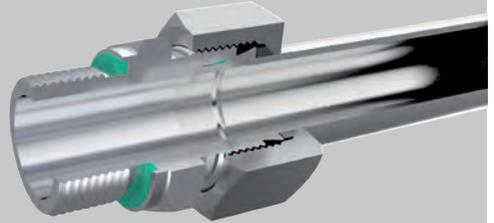

2

Tube preparation

2.1 When determining the tube lengths to be used, dimensions L1 and L2 have to be taken into consideration. The forming process compresses the tube and shortens it by the length L1.

In addition, the minimum lengths A1, A2 and B1, B2 required for clamping the tube ends have to be taken into consideration.

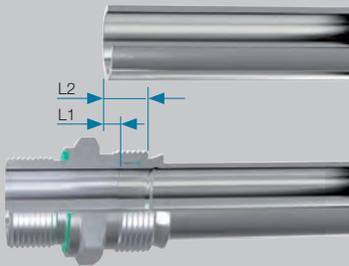

Height of the completely assembled VOSSForm^{SQR}VA connection.

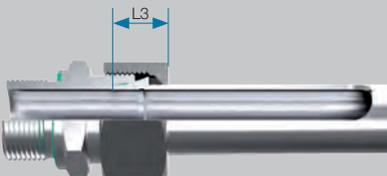

Series	Tube OD [mm]	s [mm]	L1 [mm]	L2 [mm]	L3 approx. [mm]	A1 [mm]		A2 [mm]		B1 [mm]	B2 [mm]
						$\alpha \leq 45^\circ$	$\alpha \leq 90^\circ$	$\alpha \leq 45^\circ$	$\alpha \leq 90^\circ$		
L	6	1	5.6	12.6	15.5	60	69	47	56	82	56
		1.5	6.1	13.1	16.0						
		2	5.5	12.5	16.0						
L	8	1	5.5	12.5	15.5	60	64	47	51	82	56
		1.5	5.7	12.7	16.0						
		2	5.2	12.2	16.0						
L	10	1	5.8	12.8	15.5	60	60	47	47	83	57
		1.5	6.0	13.0	16.0						
		2	5.2	12.2	16.0						
L	12	1	5.9	12.9	15.5	60	60	47	47	83	57
		1.5	5.7	12.7	16.0						
		2	5.1	12.1	16.0						
L	15	1.5	6.5	13.5	17.5	70	70	56	56	96	68
		2	5.8	12.8	17.5						
		2.5	5.6	12.6	17.5						
L	18	1.5	6.7	14.2	18.5	75	75	61	61	101	73
		2	5.8	13.3	18.5						
		2.5	5.5	13.0	18.5						
L	22	1.5	7.1	14.6	20.0	85	85	70	70	113	83
		2	6.6	14.1	20.0						
		2.5	6.2	13.7	19.5						
L	28	2	6.7	14.2	19.5	93	93	79	79	120	92
		2.5	6.2	13.7	19.5						
		3	6.3	13.8	19.5						
L	35	2	9.0	19.5	24.0	107	107	87	87	142	102
		2.5	8.1	18.6	24.0						
		3	8.6	19.1	25.0						
L	42	2	8.4	19.4	24.5	117	117	97	97	152	112
		2.5	8.4	19.4	24.5						
		3	8.6	19.6	25.5						

VOSSForm^{SQR}VA

Minimum lengths for clamping in straight tubes.

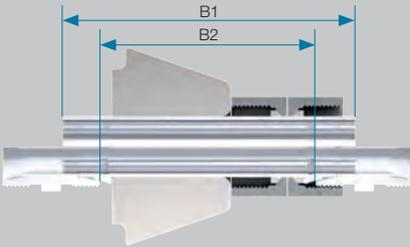

Minimum lengths for clamping in curved tubes
($R \geq 3x$ Tube OD).

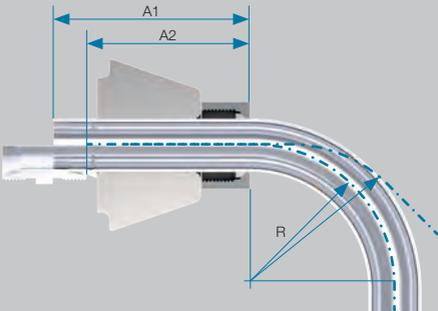

Series	Tube OD [mm]	s [mm]	L1 [mm]	L2 [mm]	L3 approx. [mm]	A1 [mm]		A2 [mm]		B1 [mm]	B2 [mm]
						$R \geq 3x DN$	$\alpha \leq 90^\circ$	$R \geq 3x DN$	$\alpha \leq 90^\circ$		
S	6	1	5.6	12.6	16.0	62	69	49	56	85	59
		1.5	6.1	13.1	16.5						
		2	5.5	12.5	16.5						
S	8	1	5.5	12.5	16.0	62	64	49	51	85	59
		1.5	5.7	12.7	16.5						
		2	5.2	12.2	16.5						
		2.5	4.7	11.7	16.5						
S	10	1.5	6.7	14.2	18.5	64	64	50	50	90	62
		2	5.9	13.4	18.5						
		2.5	5.5	13.0	18.5						
S	12	1.5	6.3	13.8	18.5	64	64	50	50	90	62
		2	5.7	13.2	18.5						
		2.5	5.3	12.8	18.5						
		3	5.0	12.5	18.5						
S	14	1.5	6.7	14.7	20.5	72	72	57	57	101	71
		2	6.3	14.3	20.5						
		2.5	5.7	13.7	20.5						
		3	5.7	13.7	20.5						
S	16	1.5	7.2	15.7	21.0	77	77	61	61	107	75
		2	6.2	14.7	21.0						
		2.5	6.0	14.5	21.0						
		3	5.8	14.3	21.0						
S	20	2	8.5	19.0	25.0	88	88	69	69	122	84
		2.5	7.7	18.2	25.0						
		3	7.3	17.8	25.0						
S	25	2	8.7	20.7	28.0	103	103	82	82	140	98
		2.5	8.0	20.0	28.0						
		3	7.6	19.6	28.0						
		4	7.6	19.6	28.0						
S	30	2.5	8.1	21.6	30.5	114	114	92	92	155	111
		3	8.7	22.2	31.5						
		4	8.4	21.9	31.5						
		5	9.8	25.8	35.5						
S	38	3	10.3	26.3	34.5	134	134	108	108	180	128
		4	10.2	26.2	35.5						
		5	9.8	25.8	35.5						

2.2 Cut off stainless-steel tubing at right angles. An angle tolerance of $\pm 1^\circ$ is permissible. Do not use tube cutters or angle grinders to cut tubes.

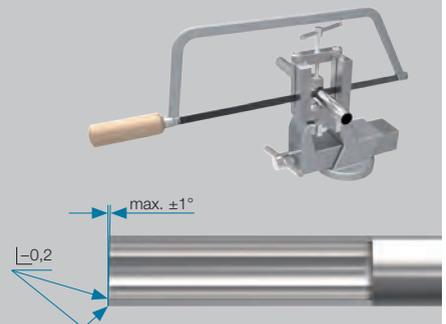

2.3 Slightly deburr tube ends inside and outside.
Clean the tube.

Attention!

Burrs on the outer and inner edges of the tube end can impair the forming process. Tubes which are not cut off squarely and correctly deburred may reduce the service life and leak-tightness of the couplings.



3

Lubricating tools and stainless steel tubes

3.1 Lubricating the tools

Clamping jaws:

After every tool change and after roughly 100 forming procedures, the outer part of clamping jaw taper must be lightly lubricated using hydraulic fluid or a non-resinous lubricant containing MoS₂. VOSS recommends that separate sets of clamping jaws be used if steel and stainless steel tubes are being used both at the same time.

Attention!

Ensure that no oil is applied to the teeth of the clamping jaw, otherwise the gripping function may be impaired.

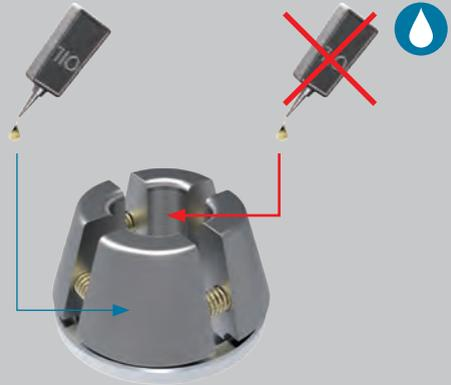

3.2 Lubricating the stainless steel tubes

To ensure fault-free forming, each tube must be lubricated on the inside and outside in the forming area with a thin film of oil. (VOSS forming oil FOE).

Attention!

If the lubricant film on the outer tubing surface is too thick, it will be trapped between the forming tool and the tube, thus leading to inaccurate contours. Always use VOSS forming oil FOE. (The use of normal hydraulic oil is not allowed).

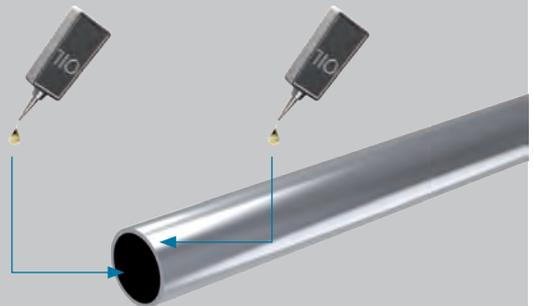

VOSSForm^{SQR}VA

4

Notes on tube forming

- 4.1** Prepare the tube forming device as described in the operating instructions and insert the tools.
- 4.2** Push the SQR-function nut onto the prepared tube end.
- 4.3** Form the tube as described in the operating instructions.



5

Checking the results

It is adequate to visually inspect the quality of the three characteristic VOSSForm^{SQR} features.



24° taper contour
Contact surface for moulded seal
Contact surface for clamping ring

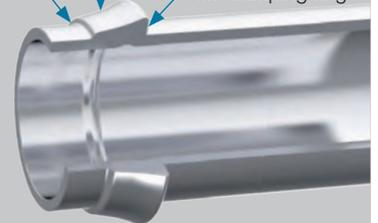

7

6

Final assembly



6.1 Install the moulded seal, ensuring that it is not twisted or damaged.

Push the pre-assembled tube end straight into the taper of the coupling connecting piece.

6.2 Apply a light film of assembly paste (e.g. MPE assembly paste) to the threads, the formed tube end, the SQR special function nut and the moulded seal.

6.3 Turn the SQR special function nut until it is hand-tight.

To achieve the final tightening torque, turn the SQR special function nut by approx. **1/2 to 3/4 of a turn.**

If the coupling is being installed on an already-installed piping system, hold the coupling connecting piece with a spanner when tightening the coupling.

Marking a stroke on the SQR-function nut and the tube makes it easier to achieve the correct number of turns when tightening the coupling.

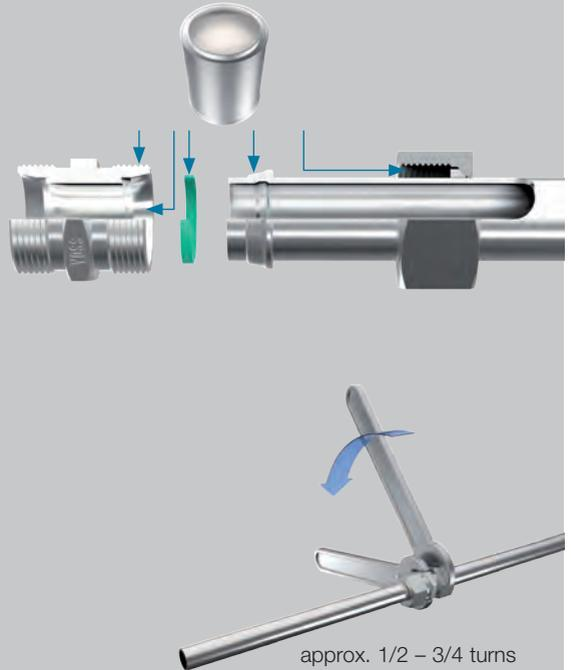

7

Re-assembly of couplings



7.1 Every time the coupling is taken apart, the moulded seal must be checked for damage and, if necessary, replaced.

7.2 For second and all following re-assembly processes, the SQR-function nut must be tightened by only **1/4 to 1/2 turns** after it has been hand-tightened.

Attention!

Before re-assembling the coupling, the 24° taper contour, the moulded seal contact surfaces and the clamping ring must be checked for damage (see 5: Checking results).



8

Tightening torques

8.1 As an alternative to achieving pre-assembly and final assembly states by distance dependent assembly, the tightening torques are guideline values which have been determined using MPE assembly paste.

Tube specifications as given in the general notes.

Series	Tube OD [mm]	Tightening torque Nm ± 5 %
L	6	25
L	8	35
L	10	55
L	12	65
L	15	90
L	18	125
L	22	150
L	28	220
L	35	380
L	42	580
S	6	30
S	8	50
S	10	65
S	12	85
S	14	115
S	16	125
S	20	220
S	25	300
S	30	430
S	38	640

Assembly instructions for BV-10 flared couplings

1

Notes

Before starting the assembly work, read and observe the general notes in the up-to-date VOSS catalogue and check that your assembly instructions are up to date.

These assembly instructions describe pre-assembly and final assembly of BV-10 flared couplings.

Attention!

Various VOSS pre-assembly devices are available for pre-assembly of the flared cone. The specifications in the respective operating instructions apply to the assembly procedures here.

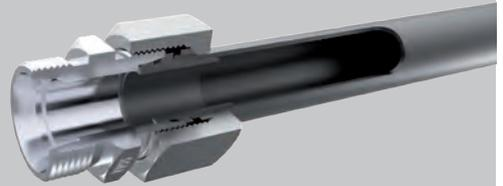

2

Tube preparation

2.1 Determine the tubing dimensions using the following table of dimensions.

Series	Tube OD[mm]	t5 [mm]	x approx. [mm]	L1 approx. [mm]	L2 approx. [mm]
L	6	7	0.8	7.8	55
L	8	7	1.1	8.1	55
L	10	7	0.5	7.5	60
L	12	7	0.5	7.5	62
L	15	7	0.5	7.5	62
L	18	7.5	1.5	9	63
L	22	7.5	1.5	9	65
L	28	7.5	1.5	9	72
L	35	10.5	2.8	13.3	75
L	42	11	3	14	75
S	8	7	2.4	9.4	55
S	10	7.5	2.4	9.9	60
S	12	7.5	2.4	9.9	60
S	14	8	3.4	11.4	65
S	16	8.5	2.5	11	65
S	20	10.5	3.5	14	70
S	25	12	3.5	15.5	75
S	30	13.5	4.5	18	75
S	38	16	5	21	78

2.2 Cut tubes at right angles. An angle tolerance of $\pm 1^\circ$ is permissible. Do not use tube cutters or angle grinders to cut tubes. Slightly deburr tube end inside and outside. Clean the tube.

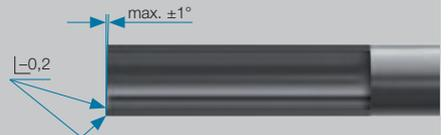
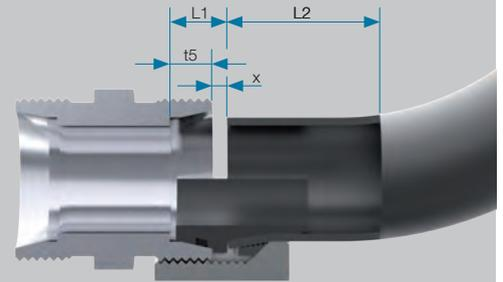

BV-10

3

Flared cone pre-assembly

3.1 Push the BV-10 union nut and the clamping ring onto the tube as shown in the diagram.

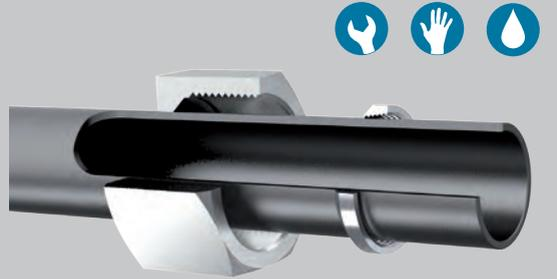

3.2 Pre-assembly principle

Only use a VOSS pre-assembly device for this process. During the pre-assembly the BV-10 flared cone is pressed into the tube.

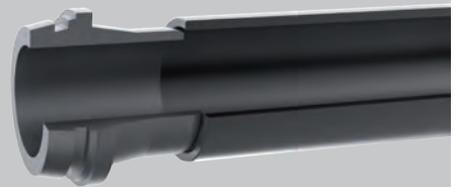

Attention!

Set up the pre-assembly device and tools as described in the corresponding operating instructions. The outer diameter and wall thickness of the tube must be observed when choosing which tools to use.

Pre-assemble the coupling as described in the operating instructions.

3.3 Apply a light film of lubricant (e.g. mineral-oil based hydraulic fluid HLP32) to toothed section and the cylindrical collar of the BV-10 flared cone and then push this onto the assembly mandrel.

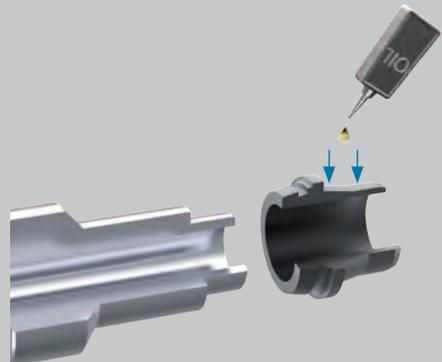

BV-10

3.4 Push the tube, with the BV-10 union nut and clamping ring on it, from the outside into the hole of the clamping jaws until it is centred on the BV-10 flared cone.

The BV-10 union nut and clamping ring must remain outside of the assembly area.

Attention!

Make sure the correct clamping jaw pressure is set. The tube must not be able to slip when the assembly process is started. Follow the relevant sections of the operating instructions for the respective pre-assembly device.

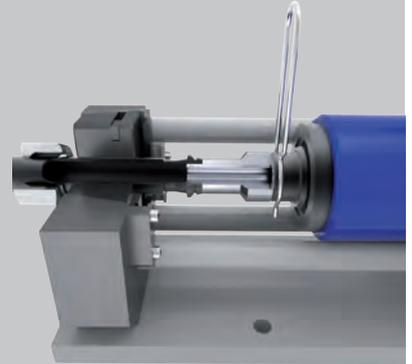

3.5 Press the BV-10 flared cone into the tube.

The optimum flared-cone assembly position is achieved when the remaining gap is ≥ 0.5 mm but not more than 1 mm.

Attention!

The BV-10 flared cone must not touch the flat surfaces of the tube end.

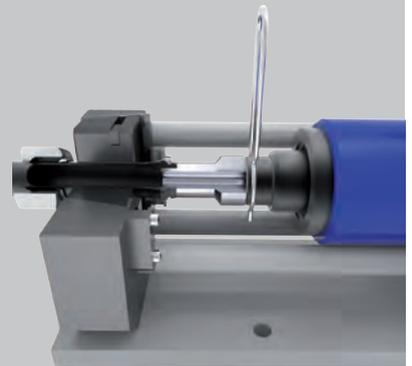

3.6 Check that the flared cone fits squarely.

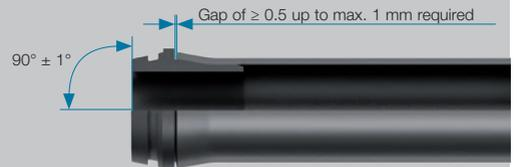

BV-10

4

Final assembly

4.1 Push the O-ring on and check that it is bedded in the groove of the flared cone without being twisted. Lubricate the threads, the taper surface and the BV-10 union nut lightly (e.g. using mineral-oil based hydraulic fluid HLP32).



4.2 Insert the pre-assembled tube end into the cone of the coupling connecting piece at a straight angle.

Attention!

Make sure the O-ring is not damaged. Ensure a tension-free connection of the pre-assembled tube and the coupling connecting piece.



4.3 Turn the BV-10 union nut until it is hand-tight.

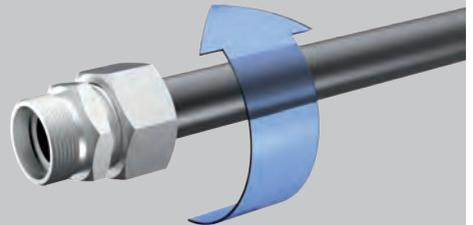

BV-10

4.4 Tighten up the coupling by turning the BV-10 union nut by approx. **3/4 – 1 full turns**.

If the coupling is being installed on an already-installed tubing system, hold the coupling connecting piece with a spanner when tightening the coupling.



5

Re-assembly

Each time the BV-10 flared cone is unscrewed, the O-ring must be checked for damage and replaced if necessary.

For the second and all ensuing re-assembly processes, the BV-10 union nut must be tightened by only **1/4 – 1/2 turns** after it has been hand-tightened.



Assembly instructions for taper (DKO) and weld nipple

1

Notes

Before starting the assembly work, read and observe the general notes in the up-to-date VOSS catalogue and check that your assembly instructions are up to date.

These assembly instructions describe the assembly of VOSS couplings and coupling parts with taper coupling (DKO) according to ISO-8434-1.

Attention!
When the tube coupling is being connected, the DKO coupling must always be held with a spanner to counter tightening torques.



2

Assembly of taper coupling

Assembly procedure

1. Check that the O-ring is not twisted and that it is bedded correctly in the groove of the taper.
2. Lubricate the threads, the cone surface and the O-ring lightly (e.g. using mineral-oil based hydraulic fluid HLP32).
3. Keeping the taper aligned, insert it into the cone and press it in firmly.

Attention!
After this step, no further alignment correction is possible.

4. Turn the union nut until it is hand-tight.
5. Then use a spanner to finally tighten up the coupling by the required angle or number of turns.

Marking a stroke on the DKO union nut and the coupling connecting piece makes it easier to achieve the correct number of turns when tightening the coupling.

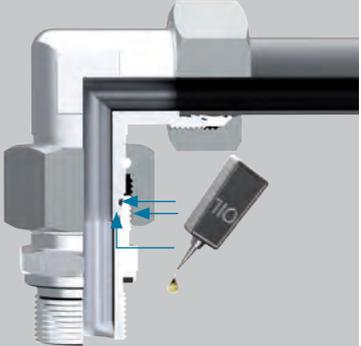
DKO

Attention!

The DKO coupling must be tightened by turning the union nut, not the counter connecting piece.

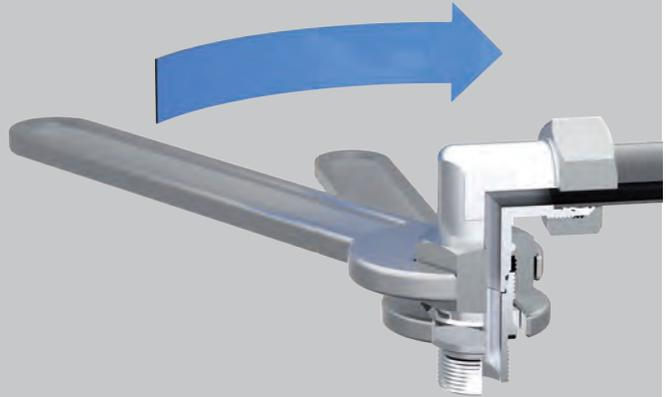

3

Assembly parameters

As an alternative to achieving pre-assembly and final assembly states by distance dependent assembly, the tightening torques can be applied directly. The stated tightening torques are guideline values which have been determined under the following conditions:

Series	Tube OD [mm]	Union nut thread	Number of turns, first assembly	Number of turns, re-assembly	Tightening torque [Nm] $\pm 5\%$
L	6	M 12 x 1.5	approx. 2/3	approx. 1/3	20
L	8	M 14 x 1.5	approx. 2/3	approx. 1/3	30
L	10	M 16 x 1.5	approx. 2/3	approx. 1/3	40
L	12	M 18 x 1.5	approx. 2/3	approx. 1/3	50
L	15	M 22 x 1.5	approx. 2/3	approx. 1/3	70
L	18	M 26 x 1.5	approx. 1/2	approx. 1/3	90
L	22	M 30 x 2	approx. 1/2	approx. 1/3	120
L	28	M 36 x 2	approx. 1/3	approx. 1/3	160
L	35	M 45 x 2	approx. 1/3	approx. 1/3	250
L	42	M 52 x 2	approx. 1/3	approx. 1/4	380
S	6	M 14 x 1.5	approx. 2/3	approx. 1/3	25
S	8	M 16 x 1.5	approx. 2/3	approx. 1/3	40
S	10	M 18 x 1.5	approx. 2/3	approx. 1/3	50
S	12	M 20 x 1.5	approx. 2/3	approx. 1/3	60
S	16	M 24 x 1.5	approx. 1/2	approx. 1/3	85
S	20	M 30 x 2	approx. 1/2	approx. 1/3	140
S	25	M 36 x 2	approx. 1/3	approx. 1/4	190
S	30	M 42 x 2	approx. 1/3	approx. 1/4	270
S	38	M 52 x 2	approx. 1/3	approx. 1/4	400

DKO

4

Assembly of weld nipple couplings

4.1 General notes

Weld nipples can be used with any tube coupling conforming to ISO 8434-1.

The weld nipples are phosphated and designed with a V-seam when delivered.

The weld nipples are welded on to the prepared tube end without the O-ring.

The user (installation company) is responsible for the welding work.

4.2 Determining the tube length

Series	Tube OD [mm]	L2
L	6	31.5
L	8	31.5
L	10	33.5
L	12	33.5
L	15	34.5
L	18	37
L	22	39.5
L	28	42.5
L	35	49.5
L	42	50
S	6	31.5
S	8	31.5
S	10	33.5
S	12	33.5
S	14	39.5
S	16	41
S	20	47
S	25	53.5
S	30	57
S	38	64

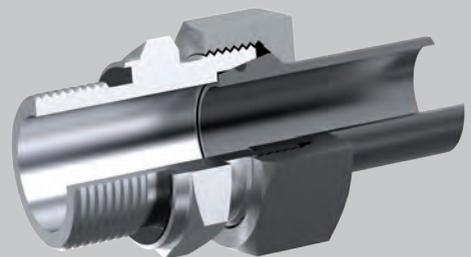
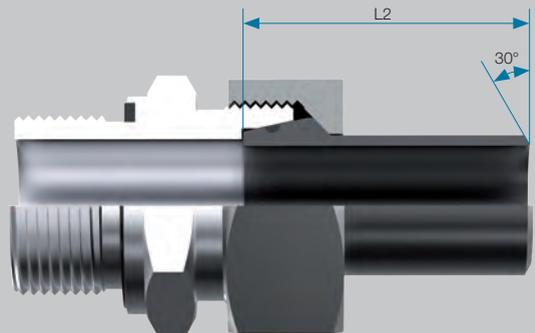

4.3 Assembly procedure

The principle of final assembly of weld nipple couplings is the same as for taper couplings.

1. Push the O-ring on and check that it is bedded in the groove of the taper without being twisted.
2. Lubricate the threads, the taper surface and the O-ring lightly (e.g. using mineral-oil based hydraulic fluid HLP32).
3. Insert the taper into the cone and press it in firmly. Turn the union nut until it is hand-tight.
4. To complete the assembly, turn the nut by approx. **1/4 turn.**

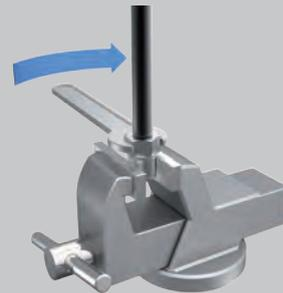
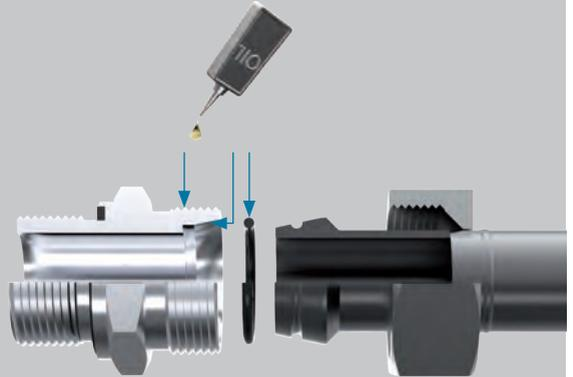

approx. 1/4 turns

Assembly instructions for flange couplings / ZAKO / ZAKO LP

1 Note

Before starting the assembly work, read and observe the general notes in the up-to-date VOSS catalogue and check that your assembly instructions are up to date.

The ZAKO flange coupling product range is designed for use in pipelines with outer diameters ranging from 16 mm to 114.3 mm. Flanges with a SAE hole pattern and square flanges can be used. For low-pressure applications, the ZAKO LP System can be used; this is available for thin-walled pipelines with tube ODs from 48.3 mm to 114.3 mm.

Different pre-assembly devices are available for the ZAKO ring assembly, depending on the tube and pipe dimensions. In each case, the descriptions given in the relevant individual operating instructions apply to the assembly procedures.

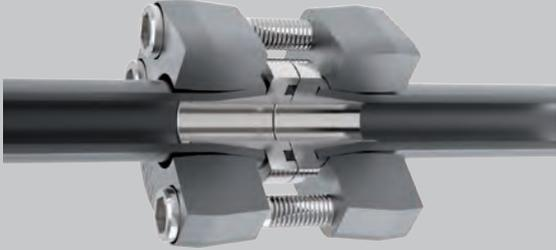

2 Tube preparation

2.1 Tube lengths for connecting flanges:

The first step in determining the required tube length is to calculate the theoretical total tube length L1. After this, the length L3 must be subtracted from the total tube length for each connection used (see table for length L3).

Tube OD [mm]	Connecting flange L3 approx. [mm]	Tube OD [mm]	Coupling flange L3 approx. [mm]	L2 approx. [mm]
ZAKO		ZAKO		
16	8	16	8	5.5
20	8	20	8	5.5
25	8.5	25	8.5	5.5
30	8.5	30	8.5	6
38/42	9	38	9	7
50	10	50	10	7
60	15	60	15	12
65	11	65	11	8
75	16	75	16	12
80	16	80	16	13
88	20	88	20	16
101.6	20	101.6	20	16
114.3	20	114.3	20	16
ZAKO LP		ZAKO LP		
48.3	10	48.3	10	7
60.3	15	60.3	15	12
76.1	16	76.1	16	12
88.9	20	88.9	20	16
114.3	20	114.3	20	16

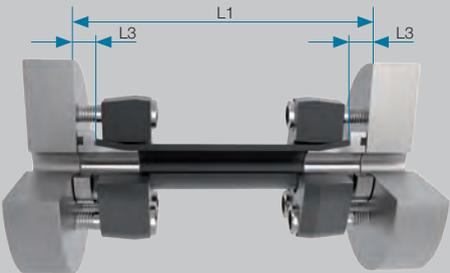

ZAKO / ZAKO LP

2.2 Tube lengths for coupling flanges:

To determine the tube lengths of coupling flanges the tube lengths L_3 applies to the connecting surface of the ZAKO ring with O-ring. If the connecting surface of the ZAKO ring without O-ring is required, length L_2 must be taken into account.

2.3 Compliance with straight tube length:

To assembly the ZAKO rings, a minimum tube length (L) of the straight tube end must be taken into account with curved tubing. Please observe the specifications listed here.

2.4 Preparing the tube ends:

Cut tubes at right angles. An angle tolerance of $\pm 1^\circ$ is permissible.

Do not use tube cutters or angle grinders to cut tubes.

Deburr the inner and outer edges of the tube ends. For the couplings to fulfil their function optimally, it is recommended that the outer edges of the tube ends be deburred only slightly and the inner edges more extensively.

The tube ends must be undamaged both internally and externally and free of metal chips, dirt, rust and other contamination.

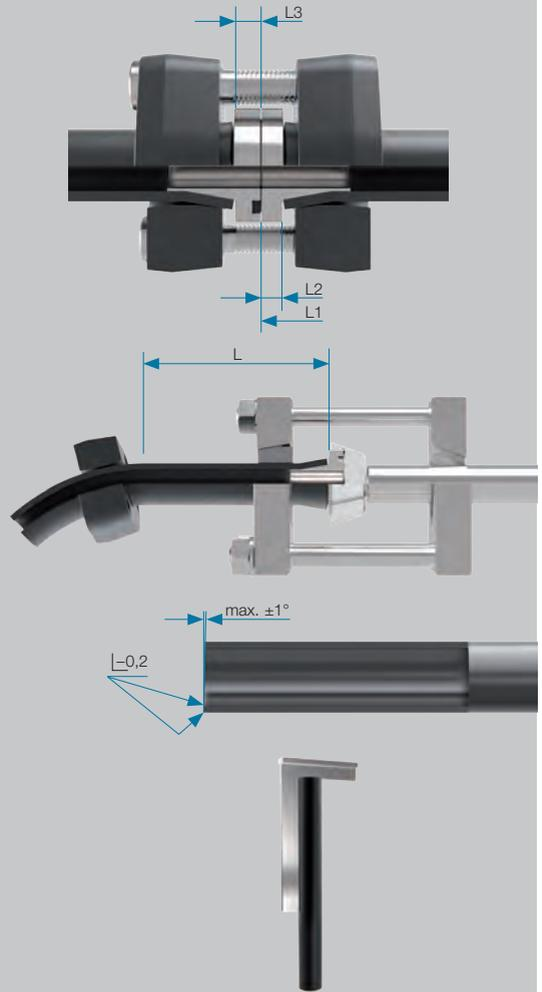

3

Principle of the ZAKO ring pre-assembly

3.1 Push the ZAKO flange onto the tube with the toothed conical section of the hole pointing towards the tube end.

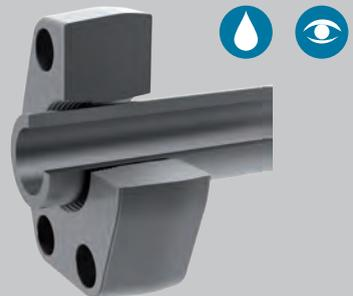

ZAKO / ZAKO LP

3.2 Pre-assembly principle

The pre-assembly procedure shown here is carried out using the VOSS pre-assembly device. Pre-assembly involves pressing the ZAKO ring into the tube.

Attention!

Set up the pre-assembly device and tools as described in the corresponding operating instructions. The tube's outer diameter and wall thickness must be taken into account when choosing what tools to use.

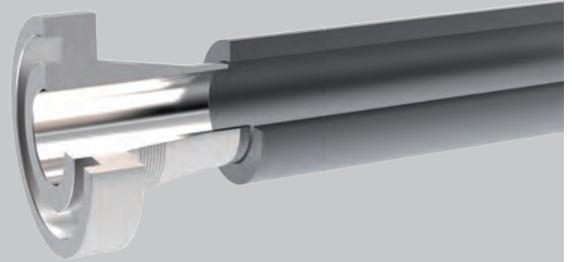

Pre-assemble the coupling as described in the operating instructions.

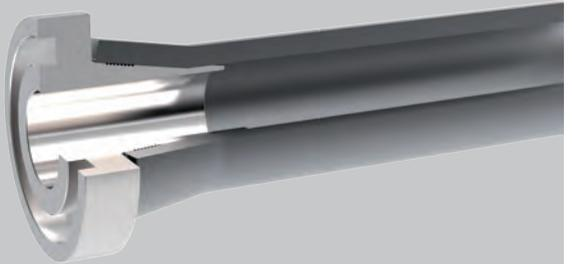

3.3 To reduce the assembly forces, lubricate the conical and cylindrical sections of the ZAKO ring generously (e.g. using mineral-oil based hydraulic fluid HLP32).

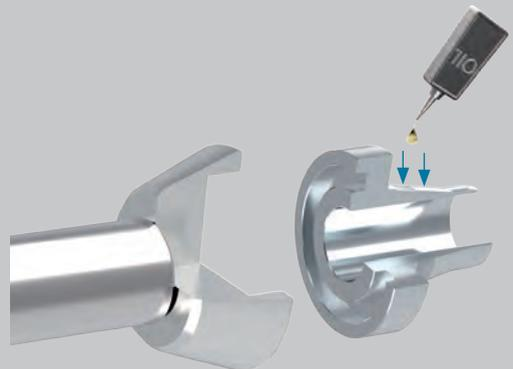

ZAKO / ZAKO LP

3.4 Push the tube through the opening of the yoke plate of the pre-assembly device and, while doing so, press the ZAKO ring against the pressure plate. Now clamp the clamping jaws around the tube. Push the clamping jaws along the tube until they are in the conical opening of the yoke plate.

The ZAKO ring must remain outside the assembly section of the tube.

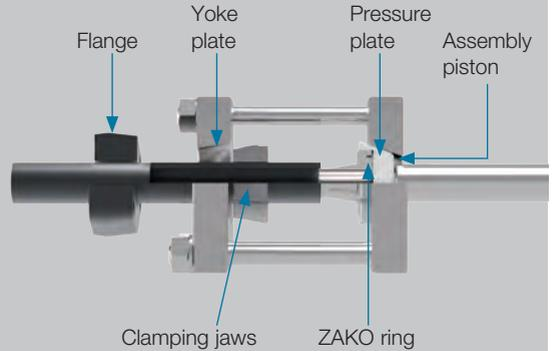

3.5 Start the assembly process as described in the pre-assembly device operating instructions. The piston stroke pushes the ZAKO ring into the tube until the remaining gap is between ≥ 1 mm and 5 mm wide (see table).

Attention!

During the pre-assembly process the tube end must not come into contact with the ZAKO ring. The remaining gap must adhere to the specified widths.

Tube wall thickness	Gap width
< 8 mm	≥ 1 to 1.5 mm
8 mm < 16 mm	max. 3 mm
16 mm	max. 5 mm

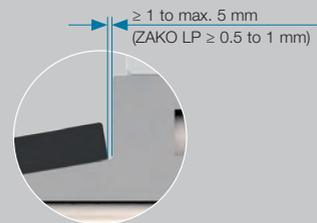

4

Final assembly of the flange connection



4.1 Clean the seal groove of the ZAKO ring and place the O-ring carefully into the groove, making sure it is not twisted.

4.2 Lubricate the threads of the screws. (e.g. using mineral-oil based hydraulic fluid HLP32).



ZAKO / ZAKO LP

4.3 Press the pre-assembled flange connection onto the surface to which it is to be bolted and screw it on hand-tight. The tube must be stress-free and at right angles to the screw on surface.

4.4 Then carefully tighten the securing screws diagonally and evenly in several steps using a wrench. The flange must be parallel to the connection surface. Should the deviation from parallel during checking (measure at all three points A, B and C) be greater than 0.5 mm, a correction must be made with reassembly.

Attention!

Do not use pneumatic wrenches.

4.5 The final assembly is concluded by alternately tightening up the diagonally opposed pairs of the 4 screws.

Attention!

Do not exceed the allowed tightening torques specified for the screws (see table).

In the course of final assembly, the collar ring may be pulled towards the tube end. It is possible that the gap will then be closed (see item 3.4).

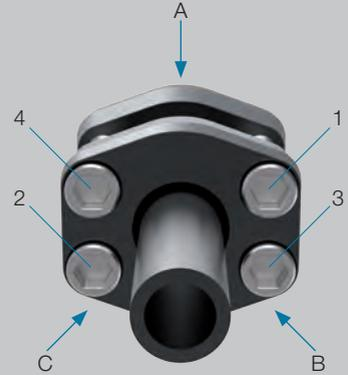

Dimension [mm]	Screw tightening torque: 10.9 [Nm max.]*
ZAKO	
M 8	35
M 10	69
M 12	120
M 14	190
M 16	295
M 20	580
M 24	800
M 30	1.500
ZAKO LP	
M 8	14
M 10	28
M 12	49
M 16	135
M 20	275

* Nm = recommended final tightening torque for cylindrical screws M 8 – M 30 for a total coefficient of friction of 0.14.

ZAKO / ZAKO LP

5

Final assembly of the flange coupling

Note that one of the collar rings used must be a collar ring without a seal groove.

5.1 Clean the seal groove of the ZAKO ring and place the O-ring carefully into the groove, making sure it is not twisted.

5.2 Lubricate the threads of the screws (e.g. using mineral-oil based hydraulic fluid HLP32).

5.3 Align the tube ends with the pre-assembled rings, fit them together and screw in the connecting screws by hand. The tubes must be perfectly aligned and must not be under tension.

5.4 Then tighten up the screws manually, alternating diagonally opposed pairs, in several stages. Ensure that the flanges are parallel to one another. Correct the screw tension if measurements (to be taken at all three points A, B and C) show a deviation of more than 1 mm from the parallel.

Attention!

Do not use pneumatic wrenches.

5.5 The final assembly is concluded by alternately tightening up the diagonally opposed pairs of the four screws.

Attention!

Do not exceed the allowed tightening torques specified for the screws (see table).

In the course of final assembly, the ZAKO ring may be pulled against the tube end. It is possible that the gap will be closed (see item 3.4).

5.6 The same notes also apply to the ZAKO flange couplings for SAE hose connections (see illustration).

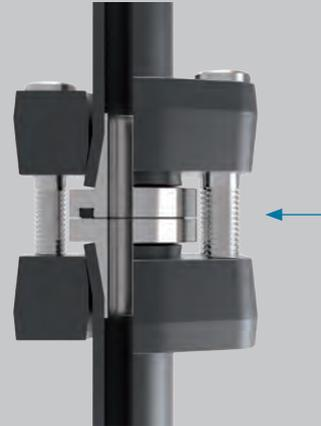

ZAKO / ZAKO LP

6

Re-assembly

Clean the seal groove of the ZAKO ring, inspect the condition of the O-ring and then put it back into the groove carefully, making sure it is not twisted.

ZAKO flanges are easy to re-assemble. Follow all the final assembly instruction steps when re-assembling a flange connection or coupling.



7

Notes on subsequent inspections

Should setting make it necessary to retighten the screws, the flange plate can be pulled up to 1mm before the ZAKO ring while taking the parallel.



7

Assembly instructions for flange couplings with cutting ring connection

1

Notes

Before starting the assembly work, read and observe the general notes in the up-to-date VOSS catalogue and check that your assembly instructions are up to date.

Pre-assembly and tube assembly processes for cutting ring / flange connections are the same as described for tube couplings (see the instructions for the corresponding coupling variants).



2

Assembly of square flange coupling with cutting ring or flared connection



Assembly of flange connecting pieces

Lubricate the O-ring and hexagon socket screws lightly (e.g. using mineral-oil based hydraulic fluid HLP32).

Clean the seal groove in the flange connecting piece and carefully place the O-ring into it, then use the four cylindrical screws and spring washers to join the flange by alternately tightening the diagonally opposed pairs of screws, taking care not to exceed the specified torque.

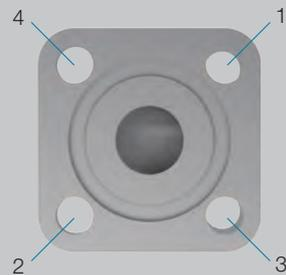

Flanges

Tightening torques

Screw ISO 4762-8.8 ¹⁾	Tightening torque Nm* -10 %
M 6	10
M 8	25

* Nm = recommended final tightening torque for screws M 6 – M 8 for a total coefficient of friction of 0.14.

Assemble the tube connection as described in the corresponding VOSS assembly instructions.

¹⁾ ISO 4762-8.8 (formerly DIN 912-8.8)

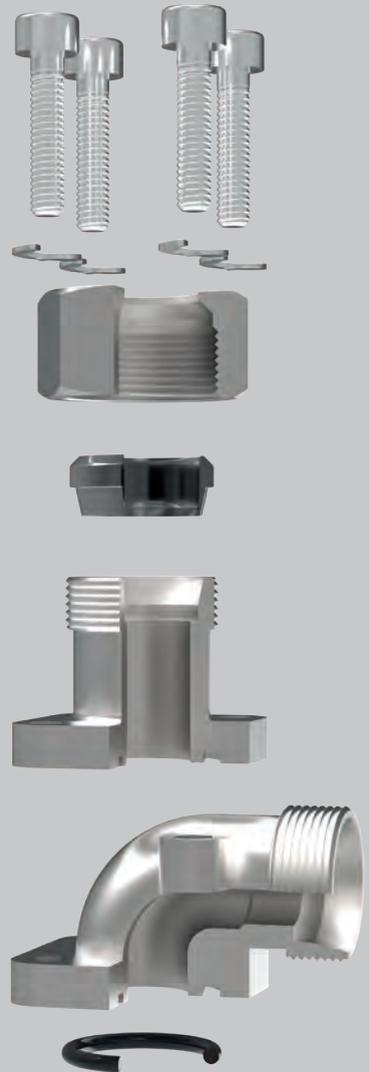

Assembly instructions for adjustable couplings as specified in ISO 6149 / 11926-1

1 Notes

Before starting the assembly work, read and observe the general notes in the up-to-date VOSS catalogue and check that your assembly instructions are up to date.

These assembly instructions apply to adjustable couplings with lock nuts to be screwed into threaded couplings with lock nuts to be screwed into threaded holes as specified in:

- ISO 6149-1 metric fine thread and
- ISO 11926-1 UN/UNF-thread

Attention!
Before installing the coupling, check the thread and the soft seal.

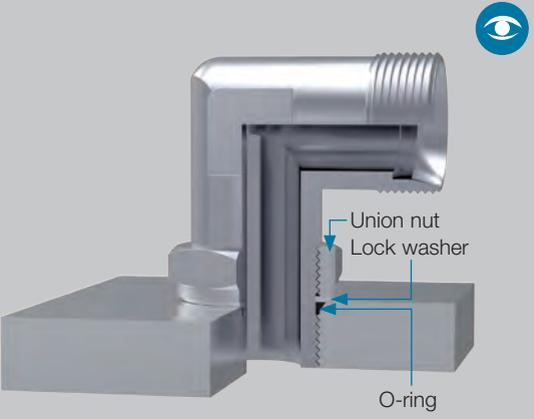

2 Assembly procedure

- Back off the lock nut as shown.
- Push the O-ring and the lock washer up to the top end of the relieved section.
- Lubricate the O-ring and the threads lightly (e.g. using mineral-oil based hydraulic fluid HLP32).
- Screw the fitting in manually until the lock washer rests on the mating surface.
- Turn the screw-in coupling back until it points in the desired direction (but not by more than one turn).
- Hold the coupling with a spanner and tighten up the lock nut.

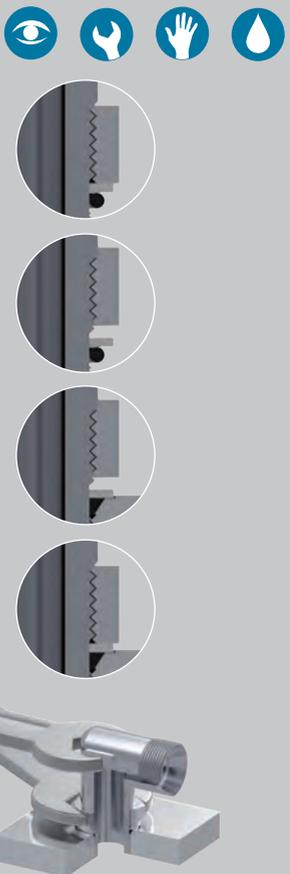

7

3

Tightening torques

Series	Thread	Tightening torque Nm -10 %
L	M 10 x 1	15
L	M 12 x 1.5	25
L	M 14 x 1.5	35
L	M 16 x 1.5	40
L	M 18 x 1.5	45
L	M 22 x 1.5	60
L	M 27 x 2	100
L	M 33 x 2	160
L	M 42 x 2	210
L	M 48 x 2	260
S	M 12 x 1.5	35
S	M 14 x 1.5	45
S	M 16 x 1.5	55
S	M 18 x 1.5	70
S	M 22 x 1.5	100
S	M 27 x 2	170
S	M 33 x 2	310
S	M 42 x 2	330
S	M 48 x 2	420

Series	Thread	Tightening torque Nm -10 %
L	7/16 - 20 UNF-2A	18
L	1/2 - 20 UNF-2A	28
L	9/16 - 18 UNF-2A	30
L	3/4 - 16 UNF-2A	50
L	7/8 - 14 UNF-2A	60
L	1 1/16 - 12 UN-2A	95
L	1 3/16 - 12 UN-2A	120
L	1 5/16 - 12 UN-2A	150
L	1 5/8 - 12 UN-2A	200
L	1 7/8 - 12 UN-2A	260
S	7/16 - 20 UNF-2A	20
S	1/2 - 20 UNF-2A	30
S	9/16 - 18 UNF-2A	35
S	3/4 - 16 UNF-2A	70
S	7/8 - 14 UNF-2A	100
S	1 1/16 - 12 UN-2A	170
S	1 5/16 - 12 UN-2A	270
S	1 5/8 - 12 UN-2A	285
S	1 7/8 - 12 UN-2A	325

Assembly instructions for adjustable elbow couplings with lock nut

1

Notes

Before starting the assembly work, read and observe the general notes in the up-to-date VOSS catalogue and check that your assembly instructions are up to date.

These assembly instructions apply to adjustable couplings with lock nuts to be screwed into threaded couplings with lock nuts as specified in:

- ISO 9974-1 metric fine thread, cylindrical
- ISO 1179-1 Whitworth pipe thread, cylindrical

Attention!
The thread and profile sealing ring PEFLEX must be checked to ensure they are clean and free of damage when beginning assembly.

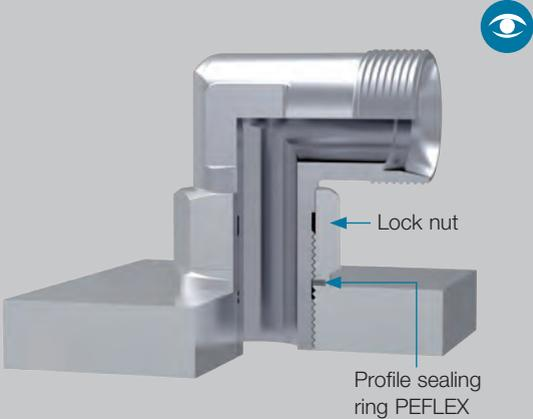

2

Assembly procedure

- Lubricate the O-ring and threads lightly (e.g. using mineral-oil based hydraulic fluid HLP32).
- Screw the coupling into the threaded hole manually until the lock nut (with the profile sealing ring PEFLEX) is in contact with the mating surface.
- Turn the coupling (by not more than one turn in the opposite direction) until it points in the desired direction.
- Hold the stud with a spanner and tighten up the lock nut, taking care not to exceed the specified torque.

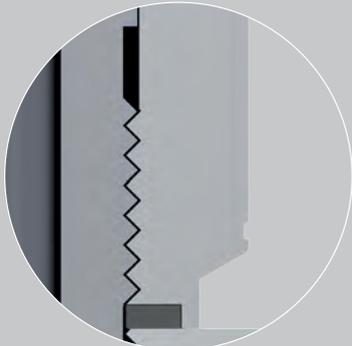

The lock nut has a marking groove on cylindrical Whitworth tube threads.

Elbow couplings

3

Tightening torques imperial

Series	Thread	Tightening torque Nm -10 %
L	G 1/8	20
L	G 1/4	50
L	G 3/8	80
L	G 1/2	105
L	G 3/4	190
L	G 1	250
L	G 1 1/4	400
L	G 1 1/2	500

Series	Thread	Tightening torque Nm -10 %
S	G 1/4	50
S	G 3/8	80
S	G 1/2	110
S	G 3/4	220
S	G 1	280
S	G 1 1/4	400
S	G 1 1/2	500

Tightening torques metric

Series	Thread	Tightening torque Nm -10 %
L	M 10 x 1	18
L	M 12 x 1.2	35
L	M 14 x 1.5	55
L	M 16 x 1.5	80
L	M 18 x 1.5	90
L	M 22 x 1.5	130
L	M 26 x 1.5	180
L	M 27 x 2	190
L	M 33 x 2	250
L	M 42 x 2	350
L	M 48 x 2	500

Series	Thread	Tightening torque Nm -10 %
S	M 12 x 1.5	35
S	M 14 x 1.5	55
S	M 16 x 1.5	80
S	M 18 x 1.5	90
S	M 22 x 1.5	130
S	M 27 x 2	220
S	M 33 x 2	250
S	M 42 x 2	350
S	M 48 x 2	500

Assembly instructions for 37° flared adapters

1

Notes

Before starting the assembly work, read and observe the general notes in the up-to-date VOSS catalogue and check that your assembly instructions are up to date.

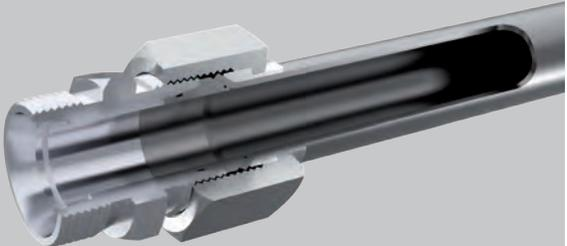

2

Assembly preparation of flared adapters

2.1 Lubricate the O-ring lightly (e.g. using mineral-oil based hydraulic fluid HLP32).

2.2 Preferably, the flare adapter should be pressed into the tube with the aid of a vice (when doing so, protect the threaded parts against damage). However, as an alternative, the flare adapter can be loosely inserted into the coupling stud.

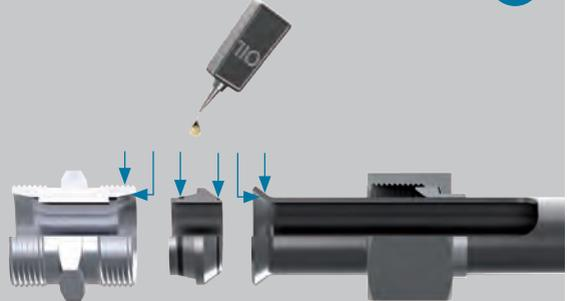

37° flared adapters

3

Tube preparation

3.1 Determine the tube dimensions with the aid of the dimension table (also refer to item 5).

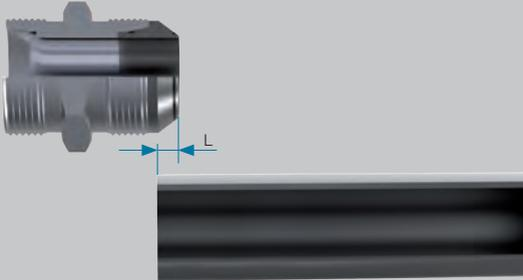

Series	Tube OD [mm]	s [mm]	L [mm]	D min. [mm]	D max. [mm]
L/S	6	1	3.5	9.1	10
		1.5	2.5		
L/S	8	1	4	11.3	12
		1.5	3		
		2	2.5		
L/S	10	1	4.5	13.1	14
		1.5	3.5		
		2	2.5		
L/S	12	1	4.5	15.3	16
		1.5	3.5		
		2	2.5		
		2	2.5		

Series	Tube OD [mm]	s [mm]	L [mm]	D min. [mm]	D max. [mm]
L	15	1.5	4.5	19.1	20
		2	3.5		
		2.5	2.5		
L	18	1.5	5.5	23.2	24
		2	4.5		
		2.5	4		
L	22	1.5	5.7	26.5	27.5
		2	4.7		
		2.5	3.7		
		3	3.2		
L	28	2	5.7	32.7	33.3
		2.5	4.7		
		3	4.2		
L	35	2	6.5	41.8	42.7
		2.5	6		
		3	5		
		4	3.5		
L	42	2	7	48.8	49.8
		3	6.5		
		4	5		
		4	5		
S	14	1.5	5.5	18.6	19.6
		2	5		
		2.5	4		
		3	3		
S	16	1.5	6.5	20.6	22
		2	5.5		
		2.5	5		
		3	4		
S	20	2	7	25.6	26.8
		2.5	6		
		3	5		
		3.5	4		
S	25	2	7	31.1	33
		2.5	6.5		
		3	5.5		
		4	4		
S	30	2	9	37	38.7
		2.5	8		
		3	7.5		
		4	5.5		
		5	4		
S	38	2.5	10	46	47.2
		3	9.5		
		4	8		
		5	6		
		5	6		
		6	7.5		

37° flared adapters

3.2 Cut tubes at right angles. An angle tolerance of $\pm 1^\circ$ is permissible. Do not use a rotary grinder or tube cutter.



3.3 Deburr the inner and outer edges of the tube ends slightly and clean the tubing.

Attention!

Burrs on the outside and inside tube diameter can impair the flaring process. Tubes which are not cut off squarely and correctly deburred may reduce the service life and leak-tightness of the couplings.



4

Pre-assembly of tube flare

Push the union nut and the supporting sleeve onto the tube. Use the standard pre-assembly devices to flare the tube end.

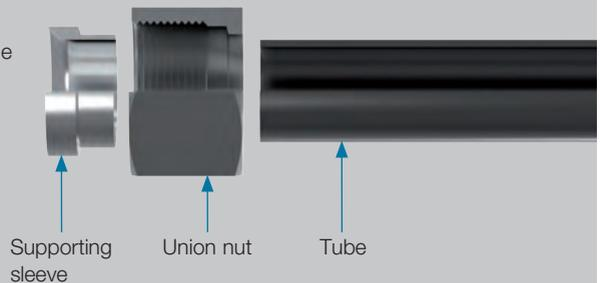

37° flared adapters

5

Checking the tube flare

For the connection to fulfill its purpose sustainably, the tube flare must be smooth and free of fissures and scratches.

See the dimension table in item 3 for the respective outer diameter (D_{\min} and D_{\max}) of the flare bell.

Attention!

Failure to keep within the dimension tolerances will impair the connection considerably.

Check the diameter

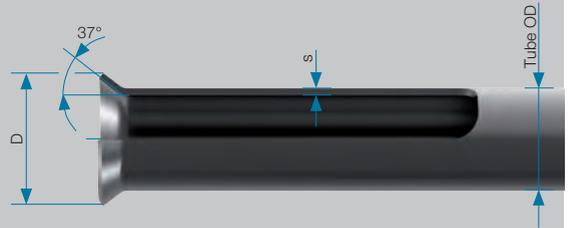

6

Final assembly

6.1 Turn the union nut until it is hand-tight.

6.2 Final assembly with pressed-in flare adapter:

Use a spanner to tighten up the union nut until a distinctly increased torque is felt.

Continue tightening by approximately **1/2 turns** (for **L6 – L12, only approx. 1/4 turns**).

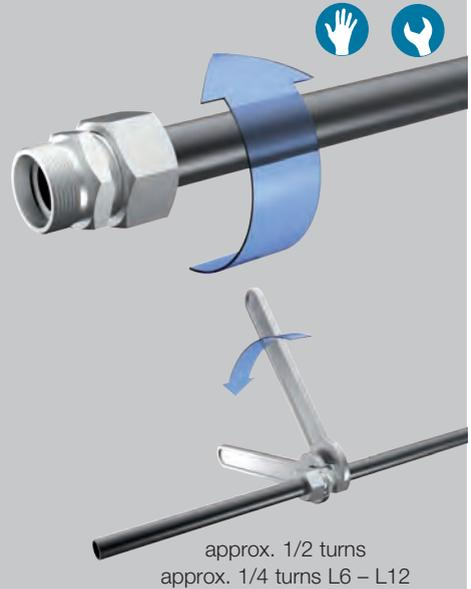

37° flared adapters

6.3 Final assembly with flare adapter inserted in connecting piece:

Use the union nut and a spanner to press the flare adapter into the connecting piece until it rests against the stop.

6.4 Unscrew the connection and check whether the flare adapter has reached the stop.

The re-tightening by approximately **1/2 turns** (for **L6 – L12, only approx. 1/4 turns**).

6.5 Turn the union nut until it is hand-tight.

Tighten the union nut with a spanner up to noticeable increase in force.

Then re-tighten by approximately **1/2 turns** (for **L6 – L12, only approx. 1/4 turns**).

Check the O-ring and the flare collar

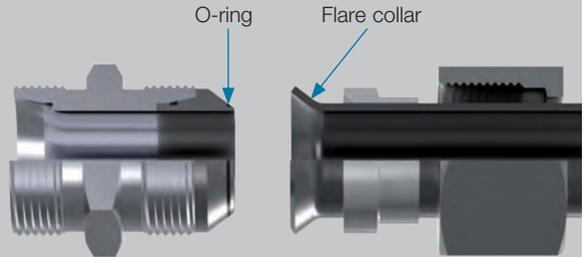

37° flared adapters

6.6 Final assembly with tightening torque

As an alternative to achieving pre-assembly and final assembly states by distance dependent assembly, the tightening torques can be applied directly. The stated tightening torques are guideline values:

Series	Tube OD [mm]	Tightening torque	
		Steel Nm \pm 5 %	Stainless steel 1.4571 Nm \pm 5 %
L	6	20	30
L	8	40	55
L	10	45	65
L	12	55	110
L	15	70	190
L	18	120	250
L	22	200	400
L	28	300	550
L	35	600	900
L	42	800	900
S	6	30	85
S	8	45	100
S	10	55	130
S	12	80	190
S	14	90	260
S	16	130	330
S	20	250	350
S	25	400	700
S	30	500	900
S	38	800	900

7

Re-assembly of connections

Every time the tube connection is taken apart, the O-ring must be carefully checked for damage and, if necessary, replaced. The tube flaring must also be cleaned and checked (see item 5).

To re-assemble the connection, tighten the union nut as described in item 6.

Check the O-ring and the flare collar

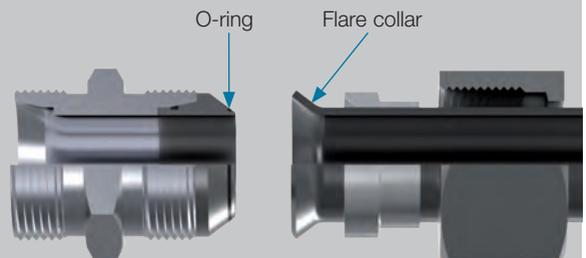

Assembly instructions for tube blanking screws – sealed with PEFLEX moulded seal rings

1 Notes

Before starting the assembly work, read and observe the general notes in the up-to-date VOSS catalogue and check that your assembly instructions are up to date.

These assembly instructions apply to the use of tube blanking screws (sealing plugs) for threaded holes as specified in:

- DIN 3852-1 / ISO 9974-1
thread: Metric fine thread, cylindrical
- DIN 3852-2 / ISO 1179-1
thread: Whitworth pipe thread, cylindrical
- Identification feature: tube blanking screws (sealing plugs) of form N with Whitworth pipe threads have an identification groove.

If the blanking screws or connections are to fulfil their purpose, it is important to adhere exactly to the assembly instructions. Wrong handling creates risks with regard to safety and leakages and may lead to complete failure of the connection or seal.

Attention!
Before application, check the thread and the soft seal.

Form N



PEFLEX moulded seal



Form V

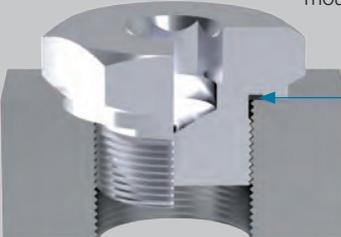

PEFLEX moulded seal

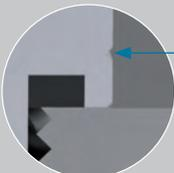

Tube blanking screws (sealing plugs) of form N with Whitworth pipe threads have an identification groove.

2 Assembly procedure

- Set the torque wrench to the torque specified for the respective component design and size in the following table.
- Lubricate the seal ring and the threads lightly (e.g. using mineral-oil based hydraulic fluid HLP32).
- Check the threads for damage.
- Screw the blanking screw (sealing plug) by hand into the threaded hole until its head is on the mating surface.
- Tighten up the blanking screw (sealing plug) to the specified final torque.



Tube blanking screws

Attention!

The recommended tightening torques relate to steel couplings with VOSS coat surface coating and which are screwed into components made of steel with a tensile strength of $\geq 350 \text{ N/mm}^2$. If other values for tensile strength, modulus of elasticity and friction-surface combinations are used, the user must adapt the tightening torques empirically.

3

Tightening torques

Thread	Form	Tightening torque Nm -10 %
M 8 x 1	N	10
M 10 x 1	N	12
M 10 x 1	V	12
M 12 x 1,5	N	23
M 14 x 1,5	N	30
M 14 x 1,5	V	30
M 16 x 1,5	N	50
M 18 x 1,5	N	65
M 18 x 1,5	V	65
M 20 x 1,5	N	75
M 22 x 1,5	N	90
M 24 x 1,5	N	90
M 26 x 1,5	N	110
M 27 x 2	N	130
M 33 x 2	N	225
M 33 x 2	V	250
M 42 x 2	N	310
M 42 x 2	V	400
M 48 x 2	N	380
M 48 x 2	V	500

Thread	Form	Tightening torque Nm -10 %
G 1/8	N	12
G 1/4	N	25
G 3/8	N	50
G 1/2	N	70
G 3/4	N	120
G 1	N	200
G 1	V	250
G 1 1/4	N	320
G 1 1/4	V	400
G 1 1/2	N	400
G 1 1/2	V	500

General technical notes

- Technical notes
- Seal types and threaded bores

Content Type/Page

Technical notes

P.457

Pressure calculations for hydraulic tubes of steel and stainless steel

P.459

Coupling system pressure ratings

P.463

Additional information –
Resistance to media,
temperatures and pressure

P.464

Pressure reduction factors and temperatures

P.465

Overview of standard threads of VOSS 24° coupling components

P.466

Seal types and threaded bores

P.467

Content	Type/Page
---------	-----------

Height of the completely assembled VOSS tube coupling	P.470
---	-------

Additional lengths when designing tube assemblies	P.472
---	-------

Calculating the equivalent straight tube length	P.473
---	-------

VOSS cutting ring systems in applications using polyamide (PA) tubing	P.474
---	-------

VOSS coat	P.475
-----------	-------

VOSS fittings' resistance to aggressive media	P.481
---	-------

Materials of the soft seals (elastomers)	P.482
--	-------

Content	Type/Page				
Ozone resistance of elastomer seals	P.483				
System comparison – requirements / system features	P.484				
Preventing faults and correcting malfunctions	VOSSRing ^M	2SVA	ES-4 / ES-4VA	VOSSForm	BV-10
	P.487	P.490	P.493	P.496	P.497
	ZAKO	DKO	VOSS 24° couplings		
	P.499	P.500	P.501		

Technical notes

General safety notes

- The couplings, flanges, valves and other components listed in the catalogue are intended for fluid engineering applications only. They cover a range of operating conditions from normal to extreme.
- In order to ensure maximum performance and functional reliability of VOSS products, the respective assembly instructions, operating conditions and tube recommendations have to be adhered to. Failure to follow these instructions may impair the function and lead to loss of claims under guarantee.
- Coupling elements must not be tightened or loosened while the system is under pressure. Caution, this involves a potential risk to life and limb!
- Piping and tubing lines are to be designed and routed in such a way that they are not under tension in the unassembled state and that all connecting elements can be easily assembled.
- Always make sure that hydraulic components are clean and are handled in a clean environment. Contamination, dirt or damage can impair the function of individual components or of the entire hydraulic system.
- When using lubricants, observe the instructions and information given by the manufacturer.
- When using VOSS pre-assembly machines/devices and tools, always observe the operating instructions. Failure to observe these instructions may endanger life and limb and/or the environment.

Standardization

In terms of design and dimensions, VOSS cutting ring tube couplings, VOSSForm^{SQR} tube couplings, flared couplings and flanges all conform to the latest version of standard DIN 2353/ISO 8434-1/DIN 3861/SAE J 518 C.

Permitted pressures

The pressure ratings stated in the VOSS catalogue are as follows:

- The nominal pressure (PN) specifies the maximum operating pressure of the coupling. This is the maximum pressure that should be applied when operating the system or the system section under stationary conditions. During load tests, the bursting pressure of the specimen must be at least 4 times the nominal pressure.
- Permissible operating pressure (PB) as defined in DIN 2401 part 1. The operating pressure ("Betriebsüberdruck" - PB) data are stated for normal operating conditions (at 120° C, static load) for a safety factor of 2.5.

For the tube-end cutting-ring connections, VOSSFormSQR or flared connection, the safety factor is always four. Always observe the pressure information for the entire article. If tube couplings are subjected to greater loads – e. g. temperatures above +120 °C, strong pressure peaks etc. – the operating pressure must be reduced in order to retain the same safety level.

It is assumed that the tubing system is firmly installed and held by tube clamps/supports in order to achieve the required functional reliability. The recommended torque moments are to be used for articles with threaded stud connections. The specified pressure values always refer to VOSS coupling components. In the case of tubing, observe the pressure values stated by the respective tube manufacturer.

Permissible operating temperatures

Coupling and flange materials

For all steel coupling and flange parts listed in this catalogue, an operating temperature range of -40 °C to +120 °C is permissible (cf. DIN 3859 part -1). If the temperature limits are exceeded, the pressure has to be decreased accordingly.

Seal materials

Standard seals of NBR (e. g. Perbunan®)

- For couplings and flared cones:
70 to 80 Shore A
- For ZAKO rings 90 Shore A
- Temperature range -35° C to +100° C

Seals of FKM/FPM e. g. Viton® upon request

- For screw couplings, flared cones and ZAKO rings
75 - 85 Shore A
- Temperature range -25° C to +200° C
The notes given in DIN 7716 (rubber products); requirements for storage, cleaning and maintenance) must be observed when using elastomer seals. w
- Dry storage at temperatures not exceeding + 25°C
- Protect against direct sunlight, ozone and strong artificial lighting

Materials

In the standard version, VOSS cutting rings, VOSSForm^{SOB}, flared couplings, valves and flanges are made of forged or drawn steel and, in exceptional cases, of cast steel, in accordance with the technical delivery conditions as specified in DIN 3859-1.

Surface protection

All VOSS tube connections are given a VOSS coat surface finish by default in order to protect them from corrosion. The only exceptions are articles whose function or normal market standard do not allow a VOSS coat finish (e. g. weld tube connection stubs).

VOSS coat corrosion prevention is based on a zinc-nickel base coat, a passivation layer and normally a top sealing coat.

The union nuts are also given a coating of lubricant/slip agent.

ZAKO flange connections have surfaces protected either by pickling and oiling or by a VOSS coat.

The parts intended for welding are shiny and oiled.

Upon request, versions made of other materials and with other surface finishes can be supplied.

Standards applied Couplings

	National	International
Cutting ring couplings	DIN 2353	ISO 8434-1
Cutting rings	DIN 3861	ISO 8434-1
Conical seal couplings	-	ISO 8434-1
Flange	-	SAE J 518 C / ISO 6162-1

Standards applied Threaded studs/Threaded holes

	Threaded stud ends	Threaded hole
	National / International	National / International
Metric fine thread	Sealing by DIN 7603 seal ring (form A)	DIN 3852-1
	Sealing by seal edge (form B)	DIN 3859-1/ ISO 9974-3
	Sealing by taper thread (form C)	DIN 3852-1
	Sealing by PEFLEX ring (form E)	ISO 9974-2
	Sealing by O-ring	ISO 6149-2 / ISO 6149-3
Whitworth pipe thread / UN-UNF / NPT	Sealing by DIN 7603 seal ring (form A)	DIN 3852-2
	Sealing by seal edge (form B)	ISO 1179-4
	Sealing by taper thread (form C)	DIN 3852-2
	Sealing by taper thread (NPT)	ANSI/ASME B 1.20.1-1983
	Sealing by PEFLEX ring (form E)	ISO 1179-2
	Sealing by O-ring (UN-UNF)	ISO 11926-2/-3 / SAE J 514

Viton® is a registered trademark of E. I. du Pont de Nemours and Company.
Perbunan® is a registered trademark of LANXESS Deutschland GmbH.



Pressure calculations for hydraulic tubes of steel and stainless steel

The pressures stated here are based on calculations carried out in accordance with DIN 2413. These calculations were carried out assuming the following boundary conditions for straight tubes and do not take into consideration any special conditions of a real hydraulic system. They are therefore only intended to assist in preliminary selection and do not release the user from his obligation to carry out own design calculations. The scope of application of the above standard shall also be observed.

Bursting pressures were calculated by a method similar to that described in ISO 10763. The assumed tensile strength values chosen in this case lead to deviations of not more than 15 % from real applications.

Pressure calculations as described in ISO 2413

Load case I – mainly static:

$$\text{Design calculation pressure } p = \frac{20 \cdot K \cdot T \cdot C1}{S \cdot Da}$$

Load case III – pulsating

$$\text{Design calculation pressure } p = \frac{20 \cdot K \cdot T \cdot C1}{S \cdot (Da + T \cdot C1)}$$

Da = outer diameter of tube [mm]

T = tube wall thickness [mm]

p = design calculation pressure [bar]

K = strength parameter [N/mm²]

S = safety factor

C1 = reduction factor for thinner tube walls

load case I – static			load case III – rising		
E235	E355	VA 1.4571	E235	E355	VA 1.4571
K = 235/225*	K = 355/345*	K = 245	K = 225	K = 230	K = 190
S = 1,5	S = 1,58	S = 1,5	S = 1,5	S = 1,5	S = 1,5
C1 = 0,9	C1 = 0,9	C1 = 0,9	C1 = 0,9	C1 = 0,9	C1 = 0,9

* For E235 and E355: a value of 10 N/mm² shall be subtracted for Da ≤ 30 and T ≤ 3mm.

Bursting pressure calculation based on ISO 10763

Calculation equation:

$$\text{burst pressure } P_b = R_m \cdot \ln \left(\frac{D_a}{D_i} \right) \cdot 10$$

Da = outer diameter of tube [mm]

Di = inner diameter of tube [mm]

Pb = bursting pressure [bar]

Rm = assumed tensile strength [N/mm²]

E235	E355	VA 1.4571
Rm = 388	Rm = 530	Rm = 468

Hydraulic tubes of E235 steel (formerly St37.4) or E355 steel (formerly St52.4) and stainless steel 1.4571:
pressure calculations as described in DIN 2413

Tube dimensions			VOSS nominal pressure		Design calculation pressures in accordance with						Bursting pressure [bar]		
Da [mm]	Di [mm]	T [mm]	L-series [bar]	S-series [bar]	DIN 2413 [bar]			Load case III			calculated in accordance with ISO 10763		
					Load case I (idle, up to +120°C)			(pulsating, up to +120°C)					
					E235	E355	1.4571	E235	E355	1.4571	E235	E355	1.4571
6	4.5	0.75	500	800	338	491	368	303	310	256	1116	1525	1346
6	4	1	500	800	450	655	490	391	400	330	1573	2149	1898
6	3	1.5	500	800	675	983	735	551	563	465	2689	3674	3244
6*	2	2	500	800	900	1310	980	692	708	585	4263	5823	5142
6*	1.5	2.25	500	800	1013	1474	1103	757	774	639	5379	7347	6488
8	6	1	500	800	338	491	368	303	310	256	1116	1525	1346
8	5	1.5	500	800	506	737	551	433	443	366	1824	2491	2200
8	4	2	500	800	675	983	735	551	563	465	2689	3674	3244
8*	3	2.5	500	800	844	1228	919	659	673	556	3806	5198	4590
10	8	1	500	800	270	393	294	248	253	209	866	1183	1044
10	7	1.5	500	800	405	590	441	357	365	301	1384	1890	1669
10	6	2	500	800	540	786	588	458	468	386	1982	2707	2391
10	5	2.5	500	800	675	983	735	551	563	465	2689	3674	3244
10*	4	3	500	800	810	1179	882	638	652	539	3555	4856	4288
12	10	1	400	630	225	328	245	209	214	177	707	966	853
12	9	1.5	400	630	338	491	368	303	310	256	1116	1525	1346
12	8	2	400	630	450	655	490	391	400	330	1573	2149	1898
12	7	2.5	400	630	563	819	613	474	484	400	2091	2857	2523
12	6	3	400	630	675	983	735	551	563	465	2689	3674	3244
12*	5	3.5	400	630	823	1180	858	624	638	527	3397	4640	4097
12*	4	4	400	630	940	1348	980	692	708	585	4263	5823	5142
14	12	1		630	193	281	210	181	185	153	598	817	721
14	11	1.5		630	289	421	315	264	270	223	936	1278	1129
14	10	2		630	386	561	420	342	349	289	1306	1783	1575
14	9	2.5		630	482	702	525	415	425	351	1714	2342	2068
14	8	3		630	579	842	630	485	496	410	2171	2966	2619
14	7	3.5		630	705	1011	735	551	563	465	2689	3674	3244
15	13	1		400	180	262	196	170	174	143	555	758	670
15	12	1.5		400	270	393	294	248	253	209	866	1183	1044
15	11	2		400	360	524	392	321	329	271	1203	1644	1452
15	10	2.5		400	450	655	490	391	400	330	1573	2149	1898
15	9	3		400	540	786	588	458	468	386	1982	2707	2391
16	14	1		630	169	246	184	160	163	135	518	708	625
16	13	1.5		630	253	368	276	233	239	197	806	1100	972
16	12	2		630	338	491	368	303	310	256	1116	1525	1346
16	11	2.5		630	422	614	459	370	378	312	1454	1986	1754
16	10	3		630	506	737	551	433	443	366	1824	2491	2200
16	8	4		630	705	1011	735	551	563	465	2689	3674	3244
18	16	1	400		150	218	163	143	146	121	457	624	551
18	15	1.5	400		225	328	245	209	214	177	707	966	853
18	14	2	400		300	437	327	273	279	230	975	1332	1176
18	13	2.5	400		375	546	408	333	341	281	1263	1725	1523
18	12	3	400		450	655	490	391	400	330	1573	2149	1898
18	10	4	400		627	899	653	500	511	422	2281	3115	2751



Tube dimensions			VOSS nominal pressure		Design calculation pressures in accordance with DIN 2413 [bar]						Bursting pressure [bar]		
Da [mm]	Di [mm]	T [mm]	L-series [bar]	S-series [bar]	Load case I (idle, up to +120°C)			Load case III (pulsating, up to +120°C)			calculated in accordance with ISO 10763		
20	17	1.5		420	203	295	221	190	194	160	631	861	761
20	16	2		420	270	393	294	248	253	209	866	1183	1044
20	15	2.5		420	338	491	368	303	310	256	1116	1525	1346
20	14	3		420	405	590	441	357	365	301	1384	1890	1669
20	13	3.5		420	494	708	515	408	417	345	1671	2283	2016
20	12	4		420	564	809	588	458	468	386	1982	2707	2391
20	10	5		420	705	1011	735	551	563	465	2689	3674	3244
22	20	1	250		123	179	134	118	121	100	370	505	446
22	19	1.5	250		184	268	200	173	177	146	569	777	686
22	18	2	250		245	357	267	227	232	192	779	1064	939
22	17	2.5	250		307	447	334	278	285	235	1000	1366	1207
22	16	3	250		368	536	401	328	335	277	1236	1688	1490
22	15	3.5	250		449	643	468	376	384	317	1486	2030	1792
22	14	4	250		513	735	535	422	431	356	1754	2396	2115
25	22	1.5		420	162	236	176	154	157	130	496	678	598
25	21	2		420	216	314	235	201	206	170	676	924	816
25	20	2.5		420	270	393	294	248	253	209	866	1183	1044
25	19	3		420	324	472	353	292	299	247	1065	1455	1284
25	18	3.5		420	395	566	412	336	343	283	1275	1741	1537
25	17	4		420	451	647	470	378	386	319	1496	2044	1805
25	16	4.5		420	508	728	529	418	428	353	1732	2365	2089
25	15	5		420	564	809	588	458	468	386	1982	2707	2391
28	25	1.5	250		145	211	158	138	141	117	440	601	530
28	24	2	250		193	281	210	181	185	153	598	817	721
28	23	2.5	250		241	351	263	223	228	188	763	1043	921
28	22	3	250		289	421	315	264	270	223	936	1278	1129
28	21	3.5	250		353	506	368	303	310	256	1116	1525	1346
28	20	4	250		403	578	420	342	349	289	1306	1783	1575
30	26	2		420	180	262	196	170	174	143	555	758	670
30	25	2.5		420	225	328	245	209	214	177	707	966	853
30	24	3		420	270	393	294	248	253	209	866	1183	1044
30	23	3.5		420	329	472	343	285	291	241	1031	1408	1243
30	22	4		420	376	539	392	321	329	271	1203	1644	1452
30	20	5		420	470	674	490	391	400	330	1573	2149	1898
30	18	6		420	564	809	588	458	468	386	1982	2707	2391
35	32	1.5	250		121	173	126	111	114	94	348	475	419
35	31	2	250		161	231	168	147	150	124	471	643	568
35	30	2.5	250		201	289	210	181	185	153	598	817	721
35	29	3	250		242	347	252	215	220	181	730	997	880
35	27	4	250		322	462	336	280	286	236	1007	1375	1215
35	25	5	250		403	578	420	342	349	289	1306	1783	1575
38	34	2		420	148	213	155	136	139	115	432	589	521
38	33	2.5		420	186	266	193	168	171	142	547	748	660
38	32	3		420	223	319	232	199	203	168	667	911	804
38	30	4		420	297	426	309	260	265	219	917	1253	1106
38	28	5		420	371	532	387	318	325	268	1185	1619	1429
38	26	6		420	445	639	464	373	382	315	1472	2011	1776
38	24	7		420	519	745	542	427	436	360	1783	2436	2151
38	22	8		420	594	851	619	478	488	404	2121	2897	2558
42	39	1.5	250		101	144	105	93	96	79	288	393	347
42	38	2	250		134	193	140	123	126	104	388	530	468
42	37	2.5	250		168	241	175	153	156	129	492	672	593
42	36	3	250		201	289	210	181	185	153	598	817	721
42	34	4	250		269	385	280	237	242	200	820	1120	989
42	32	5	250		336	481	350	290	297	245	1441	1273	

* DIN 2413 no longer applies to these tubes (because od/id > 2.0)

Dimensions

The dimensions given in the catalogue have been adapted to currently valid standards. We reserve the right to make changes due to technical advances and developments.

Patents

We make reference here to our patents at home and abroad, as well as our registered designs, trade marks and intellectual property applications.

Approvals

For approvals, see Chapter 9.

Tightening torques for threads

The recommended tightening torques refer to steel threads with VOSS coat surface finish and a steel mating material with a breaking stress of 350 N/mm².

Steel threads with increased pressure level require a mating material with a breaking stress of ≥ 600 N/mm².

If other values for strength, modulus of elasticity and friction-surface combinations are used, the user must adapt the tightening torques empirically.

VOSS notes, operating instructions and assembly instructions are to be followed in order for the parts to fulfil their proper function.

The recommended tightening torques have to be adhered to if the pressure range is to be fully utilized and the appropriate safety level is to be maintained.

The tightening torques for the threads are given in the tables for the respective type of thread.

Recommended steel tubes

The following table contains recommendations for the tube connections listed in the catalogue.

The values in the table refer to DIN 2413 class III dynamic loads at up to 120° C and tube material 1.0255+N, without corrosion factor supplement.

There are a number of different German and international standards concerning calculation of the required dimensions of tubes under internal pressure.

We recommend standard DIN EN 13480-3, which explains the various load cases in great detail.

Specifications concerning permissible steel tubes:

Seamless, cold-drawn and normalized precision steel tubing as specified in DIN EN 10305-4, material E235+N, mat. no. 1.0308+N or E355, mat. no. 1.0580. The tubes must be ordered by specifying the outer diameter and the inner diameter.

Specifications concerning permissible stainless steel tubes:

Seamless cold-drawn and solution-annealed, scale-free stainless-steel tubes in CFA or CFD delivery condition of dimensions and tolerances in accordance with DIN EN 10305-1 and all other delivery conditions as specified in DIN EN 10216-5, material X6CrNiMoTi17-12-2, mat. no. 1.4571. The tubes must be ordered by specifying the outer diameter and the inner diameter.

To stabilize the connections, thin-walled steel tubes must be fitted with reinforcing internal sleeves.

Media resistance

VOSS cutting ring couplings, VOSSForm^{SO®} tube couplings, flared couplings and flanges are designed for use with normal commercially available hydraulic fluids at temperatures of up to +100° C and compressed air at temperatures up to +80° C.

If use with critical media such as low-flammability pressure fluids is intended, please consult our customer service department.

Orders

All articles described in this catalogue are delivered as depicted in the catalogue. Items are delivered in closed package units to facilitate warehousing and to protect them from dirt and damage.

Orders should be matched to the contents of the respective package units. The number of items in the individual package units are stated in the currently valid price list. If you require smaller quantities, i. e. less items than are contained in one package unit, we recommend that you purchase these from one of our dealers.

The general terms and conditions stated at www.voss.net apply to all business dealings.

Service for customers

Let our customer service department advise you. Simply contact our sales department or a member of our field service.

Coupling system pressure ratings

Nominal pressure (PN)

The nominal pressure specifies the maximum operating pressure of the coupling. This is the maximum envisaged pressure when the system or the system section is operated under stationary conditions. During load tests, the bursting pressure of the specimen must be at least 4 times the nominal pressure.

Series	VOSSRing ^M PN	ES-4 PN	BV-10 PN	VOSSForm ^{SQR} PN
L 6	500	500	500	500
L 8				
L 10				
L 12	400	400	400	400
L 15				
L 18				
L 22	250	250	250	250
L 28				
L 35				
L 42				
S 6	800	800	800	800
S 8				
S 10	630	630	630	630
S 12				
S 14				
S 16	420	420	420	420
S 20				
S 25				
S 30				
S 38				

Additional information – Resistance to media, temperatures and pressure

Pressure reduction factors and temperatures

Pressure reduction factors within permitted operating temperatures in °C	Material				
	steel couplings	stainless-steel (1.4571) couplings	Seals of NBR (e. g. Perbunan®)	Seals of FPM/FKM (e. g. Viton®)	
-60					
-50					
-40	0 %	0 %			
-35					
-25					
+20				0 %	0 %
+50			4 %		
+100	11 %				
+120					
+150	10 %	14 %			
+175	15 %	18 %			
+200	20 %				
+250	29 %	28 %			
+300					
+400		33 %			

- permitted operating temperature
- permitted ambient temperature for hydraulic applications
- temperature not permitted

Seal durability with hydraulic fluids

Pressure fluids	Temperature resistance of seals	
	VOSS NBR	VOSS FPM/FKM
HL, HLP, HVLV	-35 °C up to +100 °C	-25 °C up to +200 °C ⁴⁾
HTG, HETG (rapeseed oils)	up to +80 °C ¹⁾	up to +100 °C
HEPG (Polyalkylene glycols) ⁵⁾	up to +80 °C ²⁾	up to +120 °C
HEES (synthetic ester oils)	up to +80 °C ³⁾	up to +120 °C

- 1) When rapeseed oil is used, even the lowest water content (0.5 %) can destroy the usability of the seals.
- 2) Depending on the quality of the oil, the seals may swell excessively and their flexibility under cold conditions may be reduced.
- 3) The wide range of HEES oils available means that the swelling rates differ considerably. General compatibility cannot be guaranteed in all cases.
- 4) For steel coupling components, the temperature range is -40 °C to +120 °C. Observe the operating range of the hydraulic fluid e. g. the flash point of HVLV is +125 °C
- 5) HEPG can only be used at up to +80 °C

Viton® is a registered trademark of E. I. du Pont de Nemours and Company.
Perbunan® is a registered trademark of LANXESS Deutschland GmbH.



Pressure reduction factors and temperatures

Permitted pressures

The pressure ratings stated in the VOSS catalog are as follows:

- The nominal pressure (PN) specifies the maximum operating pressure of the coupling. This is the maximum intended pressure when operating the system or the system section under stationary conditions. During load tests, the bursting pressure of the specimen must be at least 4 times the nominal pressure.
- Permissible operating pressure (PB) as defined in DIN 2401 part 1. The operating pressure ("Betriebsüberdruck" - PB) data are stated for normal operating conditions (at +120° C, static load) and a safety factor of 2.5.

At higher temperatures, the pressures must be reduced to below those stated in the catalog by a factor depending on the materials used. The intended operating temperature must be taken into consideration when selecting coupling and seal materials.

Caution!

When selecting tubes, please observe the pressure reduction factors stated by the tube manufacturers.

Calculation example:

Coupling:

VOSSForm^{SQR} tube OD S 10 = 800 bar nominal pressure

Temperature:

+150 °C

Material:

steel

Pressure reduction factor (see table):

10 %

Formula:

PN (coupling at +150° C)

$$= \frac{800 \text{ bar}}{100 \%} \times (100 \% - 10 \%) = 720 \text{ bar}$$

Overview of standard threads of VOSS 24° coupling components

Imperial thread [G]

Metric thread [M]

Series	Tube-OD	Male		Union nut	
		Whitworth pipe thread	Width across flats	Metric fine thread	Width across flats
LL	4	G 1/8"	10	M 8 x 1	10
LL	5	G 1/8"	11	M 8 x 1	11
LL	6	G 1/8"	11	M 10 x 1	11
LL	8	G 1/8"	12	M 10 x 1	12
L	6	G 1/8"	14	M 10 x 1	14
L	8	G 1/4"	19	M 12 x 1.5	17
L	10	G 1/4"	19	M 14 x 1.5	19
L	12	G 3/8"	22	M 16 x 1.5	22
L	15	G 1/2"	27	M 18 x 1.5	24
L	18	G 1/2"	27	M 22 x 1.5	27
L	22	G 3/4"	32	M 26 x 1.5 (ISO 6149 = M 27 x 2)	32
L	28	G 1"	41	M 33 x 2	41
L	35	G 1 1/4"	50	M 42 x 2	50
L	42	G 1 1/2"	55	M 48 x 2	55
S	6	G 1/4"	19	M 12 x 1.5	17
S	8	G 1/4"	19	M 14 x 1.5	19
S	10	G 3/8"	22	M 16 x 1.5	22
S	12	G 3/8"	22	M 18 x 1.5	24
S	14 *	G 1/2"	27	M 20 x 1.5	27
S	16	G 1/2"	27	M 22 x 1.5	27
S	20	G 3/4"	32	M 27 x 1.5	32
S	25	G 1"	41	M 33 x 2	41
S	30	G 1 1/4"	50	M 42 x 2	50
S	38	G 1 1/2"	55	M 48 x 2	55

In addition to the standard dimensions as specified in ISO 8434-1, other male part thread sizes are available. Detailed dimension information is given on the respective pages of the catalogue.

* Tube size S14 is no longer covered by the applicable standards.

Seal types and threaded bores

for VOSS tube couplings

Male thread:
metric fine thread, cylindrical

Standard PEFLEX and O-ring
seals are of NBR,
-35 °C to +100 °C

FPM/FKM seals for
-25 °C to +200 °C

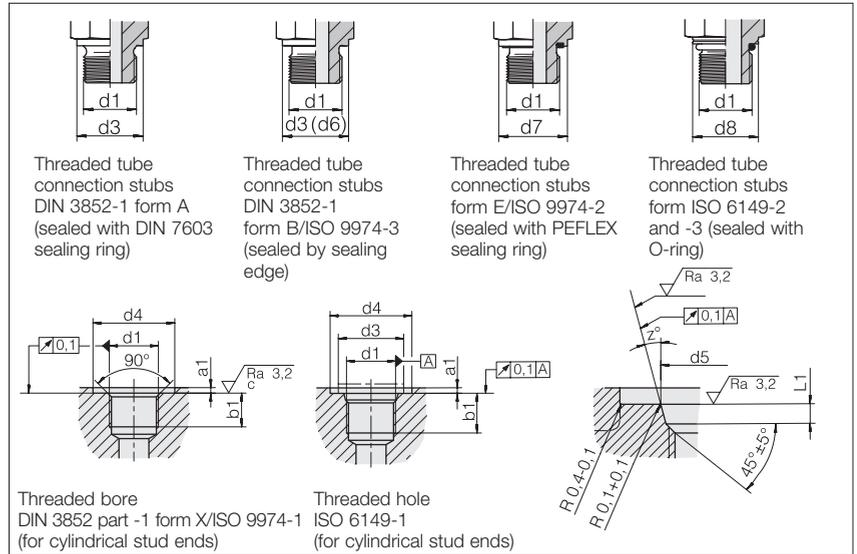

Tube OD	L	S	d1	d3 (d6)	d4 +0.4	d4 (wide) +0.4	d4 min.	d5 +0.1	d7	d8 ±0.2	a1 max.	b1 min.	L1 +0.4	Z° ±1°
DIN 3852														
4	-	-	M 8 x 1	12			13				1	8		
6 / 8	6	-	M 10 x 1	14		20	15		13.9		1	8		
-	8	6	M 12 x 1.5	17		25	18		16.9		1.5	12		
-	10	8	M 14 x 1.5	19		25	20		18.9		1.5	12		
-	12	10	M 16 x 1.5	21		28	23		21.9		1.5	12		
-	15	12	M 18 x 1.5	23		30	25		23.9		2	12		
-	-	14	M 20 x 1.5	25		34	27		25.9		2	14		
-	18	16	M 22 x 1.5	27		34	28		26.9		2.5	14		
-	22	-	M 26 x 1.5	31		42	33		31.9		2.5	16		
-	-	20	M 27 x 2	32		42	33		31.9		2.5	16		
-	28	25	M 33 x 2	39		47	41		39.9		2.5	18		
-	35	30	M 42 x 2	49		56	51		49.9		2.5	20		
-	42	38	M 48 x 2	55		65	56		54.9		2.5	22		

ISO 6149														
-	6	-	M 10 x 1	14.5	16				11.1	13.8	1	10	1.6	12
-	8	6	M 12 x 1.5	17.5	19				13.8	16.8	1.5	11.5	2.4	15
-	10	8	M 14 x 1.5	19.5	21				15.8	18.8	1.5	11.5	2.4	15
-	12	10	M 16 x 1.5	22.5	24				17.8	21.8	1.5	13	2.4	15
-	15	12	M 18 x 1.5	24.5	26				19.8	23.8	2	14.5	2.4	15
-	18	16	M 22 x 1.5	27.5	29				23.8	26.8	2	15.5	2.4	15
-	22	20	M 27 x 2	32.5	34				29.4	31.8	2	19	3.1	15
-	28	25	M 33 x 2	41.5	43				35.4	40.8	2.5	19	3.1	15
-	35	30	M 42 x 2	50.5	52				44.4	49.8	2.5	19.5	3.1	15
-	42	38	M 48 x 2	55.5	57				50.4	54.8	2.5	22	3.1	15

¹⁾ 0.1 ≤ M 22 x 1.5
0.2 ≥ M 26 x 1.5

Seal types and threaded bores

for VOSS tube couplings

Male thread:
Whitworth pipe thread,
UN/UNF thread
cylindrical

Standard PEFLEX and O-ring
seals are of NBR,
-35 °C to +100 °C

FPM/FKM seals for
-25 °C to +200 °C

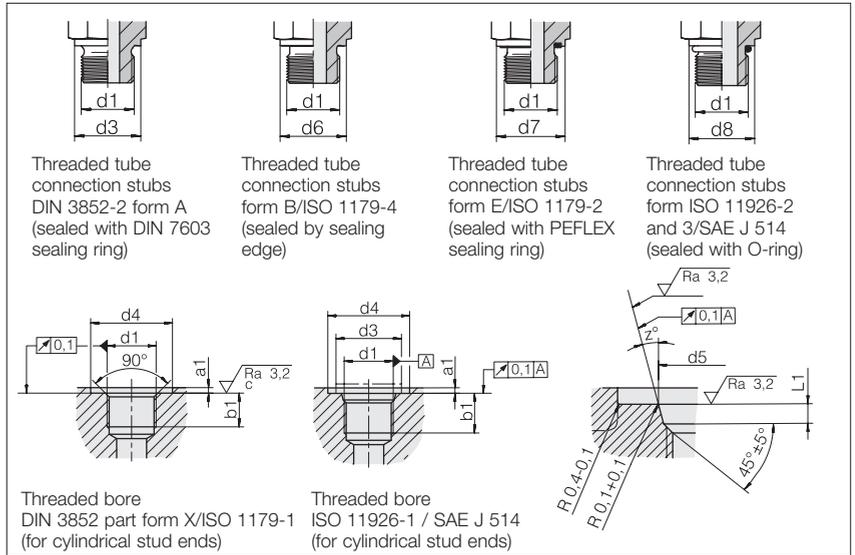

Tube OD	S	d1	d3	d4	d4 (wide)	d4	d5	d7	d8	a1	b1	L1	Z°
LL L		^{2) 3)}	(d6)	+0.4	+0.4	min.	+0.05		±0.2	max.	min.	+0.4	±1°

DIN 3852

4 - 8	6	-	G 1/8 A	14	19	15	12.45	13.9	14.4	1.6	11.5	2.4	12
-	8 / 10	6 / 8	G 1/4 A	18	25	20	14.05	18.9	16.2	1.6	11.5	2.4	12
-	12	10 / 12	G 3/8 A	22	28	23	15.7	21.9	17.6	1.6	12.7	2.5	12
-	15 / 18	14 / 16	G 1/2 A	26	34	28	20.65	26.9	22.3	2.4	14.3	2.5	15
-	22	20	G 3/4 A	32	42	33	24	31.9	25.5	2.4	16.7	2.5	15
-	28	25	G 1 A	39	47	41	29.2	39.9	31.9	2.4	19	3.3	15
-	35	30	G 1 1/4 A	49	58	51	32.4	49.9	35	2.4	19	3.3	15
-	42	38	G 1 1/2 A	55	65	56	35.55	54.9	38.2	3.2	19	3.3	15
-			G 2 A	68	76	69	43.55		47.7	3.2	19	3.3	15

ISO 11926

-	8 / 10	8	7/16-20 UNF-2A	15	21		12.45		14.4	1.6	11.5	2.4	12
-	8	8	1/ 2-20 UNF-2A	16	23		14.05		16.2	1.6	11.5	2.4	12
-	12	10 / 14	9/16-18 UNF-2A	18	25		15.7		17.6	1.6	12.7	2.5	12
-	12 - 18	12 - 20	3/ 4-16 UNF-2A	23	30		20.65		22.3	2.4	14.3	2.5	15
-	12 - 22	16 - 20	7/ 8-14 UNF-2A	26	34		24		25.5	2.4	16.7	2.5	15
-	22 / 28	20 / 25	1 1/16-12 UN -2A	32	41		29.2		31.9	2.4	19	3.3	15
-	35		1 3/16-12 UN -2A	35	45		32.4		35	2.4	19	3.3	15
-	22 - 35	25 / 30	1 5/16-12 UN -2A	39	48.9		35.55		38.2	3.2	19	3.3	15
-	35 - 42	30 / 38	1 5/ 8-12 UN -2A	48	58		43.55		47.7	3.2	19	3.3	15
-	42	38	1 7/ 8-12 UN -2A	54	65		49.9		54	3.2	19	3.3	15

¹⁾ 0.1 ≤ G 1/2
0.2 ≥ G 3/4

²⁾ "A" is not relevant for
Whitworth pipe threads
(internal/female thread).

³⁾ Threaded bore UN-UNF-2B



Seal types and threaded bores

for VOSS tube couplings

Male thread:
metric fine thread, conical

Whitworth pipe thread,
conical

NPT thread

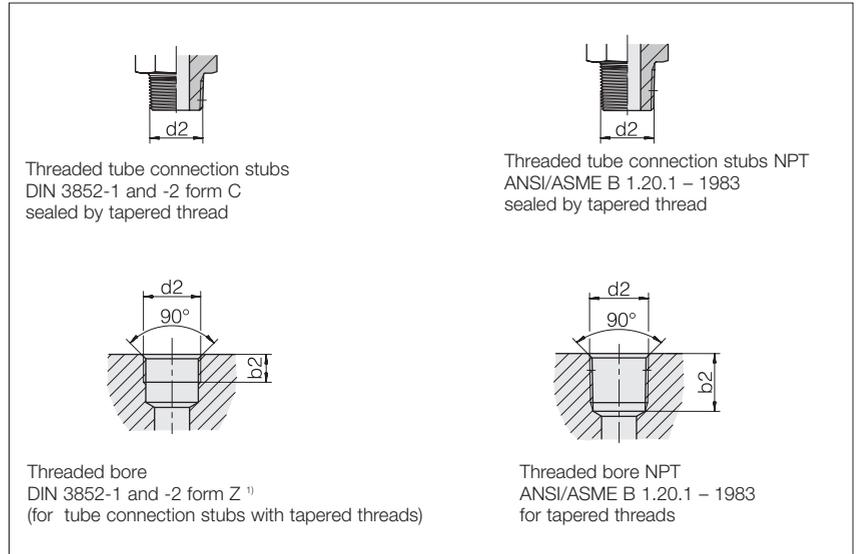

Series	Tube OD	d2		b2 min.	d2	b2 min.	d2	b2 min.
LL	4	M 8 x 1	keg	5.5	R 1/8	5.5	1/8 NPT	11.6
LL	6	M 10 x 1	keg	5.5	R 1/8	5.5	1/8 NPT	11.6
LL	8	M 10 x 1	keg	5.5	R 1/8	5.5	1/8 NPT	11.6
L	6	M 10 x 1	keg	5.5	R 1/8	5.5	1/8 NPT	11.6
L	8	M 12 x 1.5	keg	8.5	R 1/4	8.5	1/4 NPT	16.4
L	10	M 14 x 1.5	keg	8.5	R 1/4	8.5	1/4 NPT	16.4
L	12	M 16 x 1.5	keg	8.5	R 3/8	8.5	3/8 NPT	17.4
L	15	M 18 x 1.5	keg	8.5	R 1/2	10.5	1/2 NPT	22.6
L	18	M 22 x 1.5	keg	10.5	R 1/2	10.5	1/2 NPT	22.6
L	22	M 26 x 1.5	keg	10.5	R 3/4	13	3/4 NPT	23.1
L	28	M 33 x 2	keg	12	R 1	16	1 NPT	27.8
L	35	M 42 x 2	keg	13	R 1 1/4	17	1 1/4 NPT	28.3
L	42	M 48 x 2	keg	13	R 1 1/2	17	1 1/2 NPT	28.3
S	6	M 12 x 1.5	keg	8.5	R 1/4	8.5	1/4 NPT	16.4
S	8	M 14 x 1.5	keg	8.5	R 1/4	8.5	1/4 NPT	16.4
S	10	M 16 x 1.5	keg	8.5	R 3/8	8.5	3/8 NPT	17.4
S	12	M 18 x 1.5	keg	8.5	R 3/8	8.5	3/8 NPT	17.4
S	14	M 20 x 1.5	keg	10.5	R 1/2	10.5	1/2 NPT	22.6
S	16	M 22 x 1.5	keg	10.5	R 1/2	10.5	1/2 NPT	22.6
S	20	M 27 x 2	keg	12	R 3/4	13	3/4 NPT	23.1
S	25	M 33 x 2	keg	12	R 1	16	1 NPT	27.8
S	30	M 42 x 2	keg	13	R 1 1/4	17	1 1/4 NPT	28.3
S	38	M 48 x 2	keg	13	R 1 1/2	17	1 1/2 NPT	28.3

¹⁾ Leak-tightness can only be achieved with liquid or elastic sealant.

Height of the completely assembled VOSS tube coupling

Dimension L3 describes the connection dimension of the tube connection used.

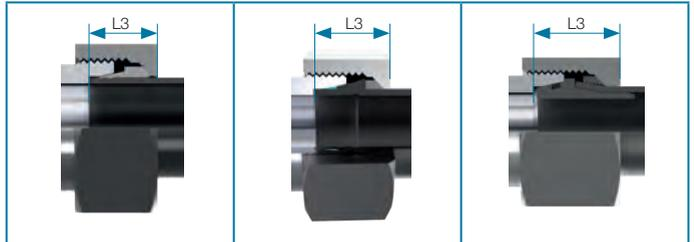

Series	s [mm]	L3 approx. [mm] Cutting rings	L3 approx. [mm] VOSSForm	L3 approx. [mm] BV-10
L 6	1	15.0	15.5	18.0
	1.5		16.0	–
	2		–	–
L 8	1	15.0	15.5	18.5
	1.5		16.0	–
	2		–	–
L 10	1	15.0	15.5	18.5
	1.5		16.0	–
	2		–	–
L 12	1	15.0	15.5	18.5
	1.5		16.0	–
	2		–	–
L 15	1	15.0	–	–
	1.5		17.5	19.5
	2		–	–
L 18	1.5	16.5	–	20.5
	2		18.5	–
	2.5		–	–
L 22	1.5	16.5	–	20.5
	2		20.0	–
	2.5		–	–
L 28	2	16.5	–	21.0
	2.5		20.0	–
	3		–	21.0
L 35	2	21.5	–	26.0
	2.5		24.0	–
	3		25.0	26.0
L 42	2	23.0	–	–
	2.5		24.5	–
	3		25.5	28.5
	4	–	–	–

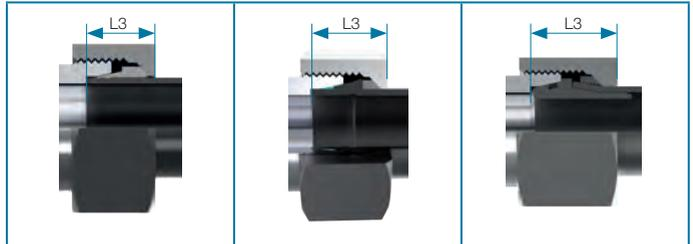

Series	s [mm]	L3 approx. [mm] Cutting rings	L3 approx. [mm] VOSSForm	L3 approx. [mm] BV-10
S 6	1	15.0	16.0	-
	1.5		16.5	
	2			
S 8	1	15.0	16.0	-
	1.5		16.5	19.0
	2			-
	2.5			
S 10	1.5	16.5	18.5	20.0
	2			-
	2.5			-
S 12	1.5	16.5	18.5	19.5
	2			-
	2.5			-
	3			19.5
S 14	1.5	18.0	20.0	-
	2		20.5	21.5
	2.5			-
	3			
S 16	1.5	18.5	21.0	-
	2			22.0
	2.5			
	3			
	4			
S 20	2	21.5	25.0	25.0
	2.5			
	3			
	3.5			
	4			
S 25	2	24.0	28.0	-
	2.5			27.5
	3			
	3.5			
	4			
S 30	2	26.5	30.5	-
	2.5		31.5	33.0
	3			
	4		32.0	-
	5			
	6			
S 38	2.5	31.0	34.5	-
	3		35.5	38.5
	4			
	5			
	6			
	7			

Additional lengths when designing tube assemblies

The following must be taken into consideration when calculating the length of tubing required for a given assembly length:

- minimum lengths of straight tube sections and of tube elbows*
- additional dimensions in the coupling connector
- additional tube sections (flaring, bend radii, elbow lengths, straight sections)

In addition, we recommend that in case of doubt some extra length be added when designing the ends of the tubes. This allows the tube length to be adjusted before commencing pre-assembly for the VOSS coupling system, if necessary.

Dimension inside coupling connecting piece

tube OD	Length up to stop inside connector [mm]
L 6	7
L 8	7
L 10	7
L 12	7
L 15	7
L 18	7.5
L 22	7.5
L 28	7.5
L 35	10.5
L 42	11
S 6	7
S 8	7
S 10	7.5
S 12	7.5
S 14	8
S 16	8.5
S 20	10.5
S 25	12
S 30	13.5
S 38	16

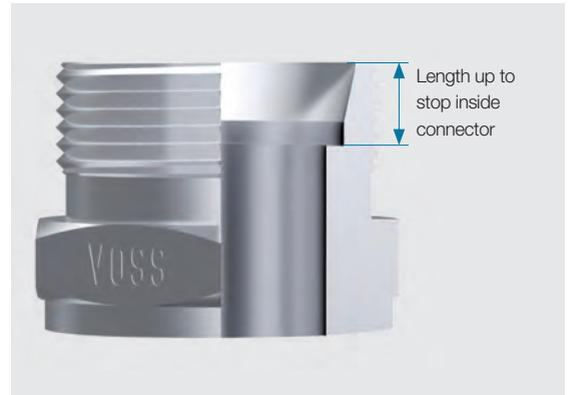

* Depends on the coupling system and pre-assembly system used.

Calculating the equivalent straight tube length

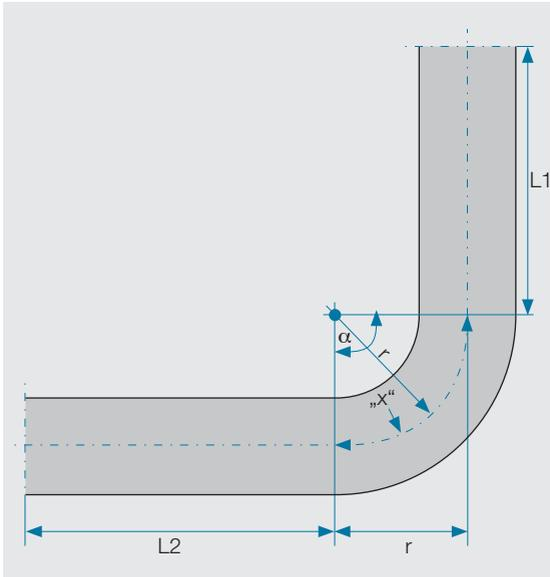

L = total equivalent straight tube length

x = equivalent tube length of elbow

α = bend angle

r = radius

$$x = \frac{\alpha \cdot 2 \cdot r \cdot \pi}{360^\circ}$$

$$L = L_1 + L_2 + x$$

Please note that the bend radius is determined by the bend template of the device.

VOSS cutting ring systems in applications using polyamide (PA) tubing

Tubing made of organic materials is becoming increasingly popular in industrial applications. These materials have a good resistance to oil, grease and fuels as well as to high and low temperatures. They are also weather-resistant and have good mechanical characteristics such as fracture and impact resistance.

Polyamide (PA) tubes possess most of these qualities. They are manufactured to extremely tight tolerances and can be easily installed using metal or plastic coupling elements.

All VOSS Fluid cutting ring systems are suitable for use with tubes made of polyamide (PA).

Polyamide (PA) tubing applications:

- Control, measuring and monitoring technology
- Laboratory equipment
- Food processing industry
- Medical technology and electrical engineering
- Automotive industry
- Plant and equipment construction
- Pneumatics

Polyamide tube material properties

- Low weight
- Corrosion and temperature resistant
- Impact resistance at both low and high temperature ranges
- Relatively high pressure resistance with low wall thicknesses
- Temperature range from -40°C up to $+80^{\circ}\text{C}$, and even up to $+100^{\circ}\text{C}$ for short periods.

Product recommendation:

VOSS cutting pliers for plastic tubes

Plastic tubes must not be sawn apart as this leads to burrs, which endanger the leak-tightness of a coupling. VOSS Fluid recommends that the VOSS plastic tube cutting pliers be used to cut plastic tubing to length. This produces burr-free and orthogonally-cut tube ends. The surfaces of the cut do not need any additional processing.



Order designation: TD-NTS

Order-No.: 5994847200

Assembly note:

Pre-assembly and final installation must always be carried out using tube support sleeve as described in the VOSS assembly instructions.

Conceived and thought through

VOSS coat

✓ Corrosion resistance
in perfection

Pioneer in zinc-nickel applications since 2007 – and still a clear leader.

EC directive 2000/53/EC on end-of-life vehicles was amended in 2007, partially banning the use of hexavalent chromium in materials and vehicles components. For us, this meant that the era of yellow chromate corrosion protection coatings had come to an end. The technological characteristics of available alternatives – using zinc as a base coat with thick-film passivation – fell a great deal short of VOSS quality requirements, and were clearly a step in the wrong direction. This move was and still is unacceptable to VOSS, since we always strive to increase the benefits for customers in our products and solutions.

Our solution: VOSS zinc-nickel surface finishes. The relevant characteristics of these coatings even surpass those of yellow-chromate finishes. Users were especially delighted by their corrosion resistance – 10 times better than before. In 2007, this was a huge leap forward in the hydraulic coupling technology market.

The steel is given three coats to provide optimum corrosion protection: a zinc-nickel base coat, a passivation layer and a sealing coat. In 2009, we set up our own electroplating competence center in which we produce and enhance our surface finishes.

Features we provide as standard are options elsewhere.

Our surface finishes have set the benchmark for corrosion resistance in all market sectors and have been used in our entire product range all around the world since 2007, at high availability levels. For you, as a customer, this means maximum process reliability for your applications, homogeneous selection of parts, no danger of confusing items. Suitable for use in hydraulic presses, plant construction, agricultural and construction machinery, conveyor engineering as well as for injection-molding machines and machine tools.



After comparative testing in a salt-spray chamber for 720 hours



VOSS Zink-Nickel



Zinc + passivation + sealing coat

The trade mark for corrosion protection.

Our surface finish is much more than just a simple coating. This is why we have made it a trademark: VOSS coat. VOSS coat is synonymous with corrosion protection in perfection, focussing on technology, sustainability and human health and safety.

VOSS coat is the result of continuous improvement – for example of friction coefficients, layer thickness relationships and visual impression. These are the result of many years of experience in production processes and with customer applications furthered by our own research and development work. Only VOSS unites this comprehensive know-how under one roof – operating a proprietary VOSS coat competence center including an electroplating test line. In this way we make sure that our corrosion protection meets your strictest standards. To achieve a measurable technological lead for you.

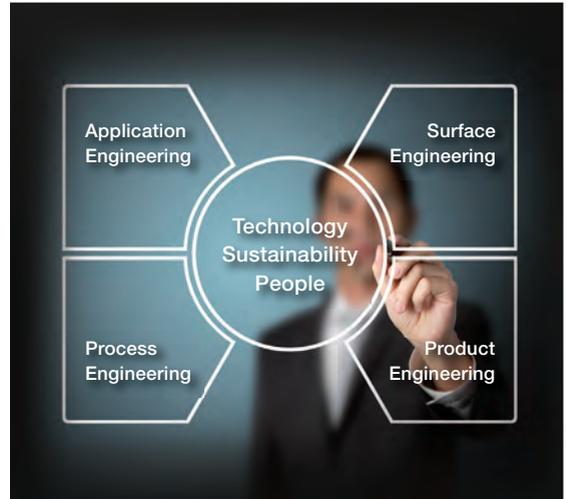

A technological lead, achieved by hard work

VOSS coat is the outcome of many years of in-house engineering that considers all the factors leading to increased benefits for the customers. Not only have we achieved an extremely high level of corrosion protection but also user-friendly handling in practical applications.

■ **1,000 hours corrosion resistance in productive applications following shipping, handling and assembly.**

Tested using random samples in the assembled state taken from series production. In view of the microscopic lesions which can occur during assembly, this is the only way of obtaining a reliable estimate of the service life to be expected in the customer's applications. Under laboratory conditions, the service life of unassembled parts exceeds 2,000 hours. After this, red rust starts to develop, whereas white rust only appears in the form of a light grey film. In addition, samples for our own quality assurance tests are taken from all production lots.

■ **Assembly testing of cutting ring coupling (size S30)**
VOSS coat ensures optimum assembly torques.

VOSS coat finish cross-section

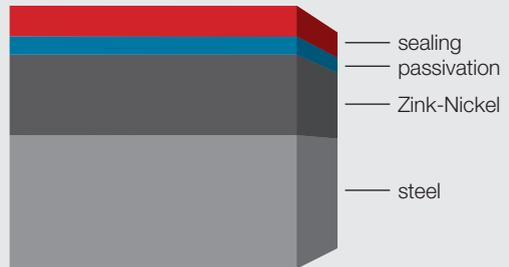

Assembly torque, in Nm

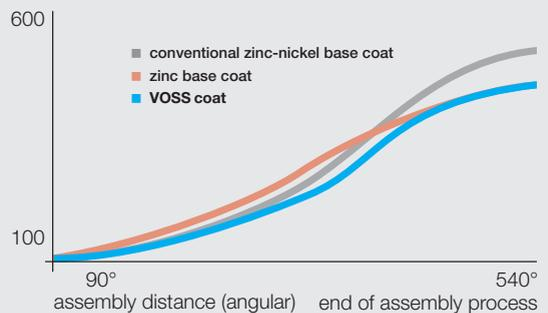

- **Perfect assembly torques – not too high and not too low**

How to avoid assemblies being too tight or too slack – thanks to our consistent quality – in all tube connections. Our own research, development and production have enabled us to continually improve the friction coefficient of VOSS coat to equal the best zinc surface finishes and have reached a value considerably lower than that of other zinc-nickel coatings.

- **Best possible process reliability thanks to a modern in-house electroplating plant with online sensors and analysis systems**

This plant is designed exclusively for tube couplings – a unique feature. This is where we work to enhance our electroplating processes – in the electroplating test laboratory for chemical components, and in the engineering department for production procedures. In series of tests, the 12 program parameters are adjusted individually for each one of our 6,600 articles in order to optimize processes for all geometries and sizes. We have developed the racks and baskets used to move the articles through the plant ourselves and are continually improving these to achieve a degree of specialization impossible with outsourced processing. We conform without exception to the European Community Regulation on chemicals and their safe use (REACH), of course.



Individual plant control programs: a separate program for controlling 12 parameters is compiled for each of our 6,600 articles.

VOSS electroplating test laboratory: where VOSS coat is being permanently improved



Sustainability: only achievable from scratch if everything is under our control.

Since 2009, we have been operating the VOSS coat competence center, with a floor area of 5,000 m², at our headquarters. To provide the best possible working conditions, the facility has two storeys: on the ground floor, all goods are transported and the test batches are fed to the racks and drums for the electroplating plant, then a lift system conveys them to the second floor. The actual electroplating process is carried out there and no workers are required on this floor. We can control all process steps in the plant and optimize them to suit our requirements, sustainably and without compromises.

■ **Energy-efficient production:**

Alongside the sophisticated energy optimization measures (e. g. heat recovery installations) installed when the facility was built bring annual energy savings of more than 490 MWh. This is the annual electric energy consumption of approximately 160 domestic dwellings

■ **Emission reductions (air pollution, water and noise):**

Extract air is drawn directly from the space above the baths and is cleaned by an air scrubber. This brings pollutant levels in the exhaust air down to values exceeding the lower limits by a factor of more than 250. The same principle applies to our responsible use of water: instead of using valuable drinking-quality water, we use process water. Waste water is cleaned and its pH value neutralized by sophisticated processes at our own treatment plant. And our electroplating plant fulfils the strictest noise emission regulations for mixed-utilization urban areas as well.

■ **Reduction of potential environmental hazards:**

We use environment-friendly materials.

■ **Raw-material efficiency and recycling:**

The online analysis process optimizes the useful life of baths to achieve low resource consumption. Metal residues are reprocessed and thus returned to the raw-material cycle.



Process chemistry – the essence of VOSS coat. Thanks to automated concentration correction in baths, process parameters remain within tight tolerances.



Our plant technology is specifically designed to prevent damage to threads.



The entire plant operation is controlled from the ground floor. All process steps and parameters are displayed and indicated in real time on control monitors.

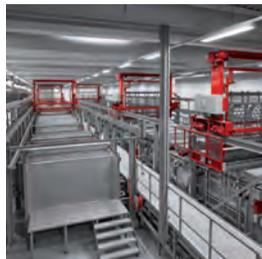

All bath parameters are continuously monitored. Chemicals are added in a fully automatic process to maintain the correct concentration.



Process optimization has led to shorter product immersion times at our facility than in other electroplating plants. This means even less stress on the material.



After electroplating, each production lot is subjected to quality control inspection of both the thickness and the chemical composition of the coating. The results of the inspections are documented.



Our flexible plant controls allow customer-specific post-processing.



Extract air is drawn directly from the space above the baths and scrubbed before being exhausted. Heat energy is recovered and recycled.

The individual: at the focus of all our activities.

Technology improves products. Sustainability ensures efficiency and conservation of resources. But only by combining these two factors do we really benefit the human beings involved. VOSS coat benefits everyone, now and in the future – staff and our customers alike.

■ Productive working conditions for our staff:

Employees and chemicals are separated by construction measures. Since concentration-adjustment dosing of the process baths is fully automated and requires no manual work, contact to chemicals is avoided. Ergonomical workplaces, eliminating lifting movements, for example, prevent fatigue and the errors associated with this.

■ Process stability in the interest of our customers

Our good process stability, in conjunction with excellent component assembly characteristics, virtually eliminates faults which might occur due to excessively tight or slack assemblies. Coating processes specifically developed for our products ensure consistently high corrosion protection – at all times – for the entire product range.

■ Nickel release:

Our nickel release rate is more than 50 times lower than the limit values defined in EC regulation 1907/2006 for the release of nickel by objects coming into direct and prolonged contact with human skin.



VOSS coat



Corrosion resistance in perfection

VOSS coat: in a class of its own.

Corrosion protection is only as good as the weakest component. So it is best not to have any weakest component. VOSS coat sets the standard when it comes to improving corrosion protection in your entire system. Safety which improves your products and impresses your customers.

Reliability:

- 1,000 hours corrosion resistance under practical conditions.
- A technological leader among surfaces, thanks to many years of experience, research and development.
- Sustainable production in our own VOSS coat competence centre.
- 455 million couplings have been delivered since 2007.
- More than 30 % of all users in Germany choose VOSS coat.
- High availability and delivery readiness: lean, rapid supply chains.
- Image enhancement and a high resale value for your machinery and plant, thanks to uncompromisingly high-quality components.
- Enhanced customer satisfaction due to minimum risk of complaint.
- Application engineering: customer specifications can be realized by our own employees (e.g. in the case of prototypes).
- Assuring the future through our own research and cooperation with universities and other higher education institutions.

Materials of the soft seals (elastomers)

To ensure maximum leakage protection, different seal materials have to be used, depending on the respective application. The suitability of the elastomer to be selected depends essentially on the media being conveyed and on the temperature range.

The default elastomer material used by VOSS for 24° tube couplings, flange couplings and valves is NBR. All DKO screw couplings, VOSSForm^{SOB} and ES-4 products are supplied with elastomer seals of FPM/FKM (e. g. Viton®).

VOSS Fluid also offers other seal materials for the entire connector product range as options.

Seal material	Nitrile butadiene rubber	Hydrated NBR	Fluoroelastomer	Ethylene propylene diene-monomer rubber
Short designation (Examples: trademarks)	NBR (e. g. Perbunan®)	HNBR	FPM/FKM (e. g. Viton®)	EPDM
Temperature range	-35 °C up to +100 °C	-30 °C up to +140 °C	-25 °C up to +200 °C	-40 °C up to +150 °C
Low temperatures	++	+	+	++
Media resistance	good	good	very good	depends on conditions
Ozone resistance	limited	good	very good	very good

Please note that the effectiveness of elastomer seals will be affected by external influences, contact with media, friction and ageing.

Therefore the elastomers should be checked for the following kinds of damage when carrying out service or maintenance work, and should be replaced when necessary:

- cracking
- rough or otherwise changed surface
- deformation
- hardening or softening
- swelling
- reduced elasticity

The notes given in DIN 7716 (rubber products; requirements for storage, cleaning and maintenance) must be observed when using elastomer seals.

- Keep in dry storage at temperatures not exceeding + 25° C
- Protect against direct sunlight, ozone and strong artificial lighting

Ozone resistance of elastomer seals

Ozone is a gas occurring naturally in the atmosphere and which protects the environment against solar ultraviolet radiation. However, ozone is also a very strong oxidizing agent that attacks virtually all organic compounds. Elastomer seal materials, e. g. NBR, are particularly sensitive in this respect. Even a low atmospheric ozone concentration can impair product quality and service life considerably.

Ozone cracks the polymer chains of the seal material, thereby increasing the danger of this tearing, even at low strain values (less than 10 %). This risk may even be increased under certain temperatures and humidity conditions.

In our production and storage processes, VOSS Fluid always ensures optimum conditions for the seal materials used. For example, all seals are protected against heat exposure, direct sunlight and soiling. Long storage times are also avoided.

To prevent damage, you should observe the following notes on storing seal materials:

- Elastomers must be stored at a temperature between +5° C and +25° C.
- Deformation of the seals during storage should be avoided.
- Seal materials should be protected against direct contact with heat sources or lighting fixtures. Direct sunlight or strong artificial lighting with an ultraviolet component must also be avoided.
- Extremely damp and extremely dry conditions must be avoided. There must be no condensation, which means that the relative humidity of the storage spaces must be lower than 70 %.
- Packaging, particularly plastic bags, must be protected against UV radiation.
- Please note that ozone can also be emitted by other sources, which means that the storerooms may not contain any mercury-vapour lamps, high-voltage equipment and electric motors or other equipment which might cause arcing or electrostatic discharges. Exposure to combustion exhaust fumes and organic gases must also be avoided.
- While in storage, elastomer seals must not be allowed to come into contact with solvents, oil and grease.
- The service life of seals depends to a large extent on the type of elastomer used. Under ideal conditions, seals made of NBR and HNBR can be stored for up to 6 years and FPM/FKM seals for up to 10 years.
- Seals pre-assembled on the couplings must be inspected for damage and contamination before they are finally installed.

System comparison – requirements / system features

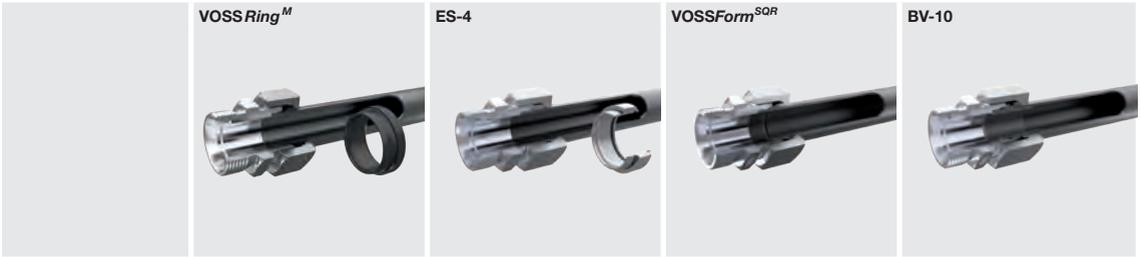

Technical comparison

General				
for tube couplings as specified in standard	DIN EN ISO 8434-1			
Series	L/S			
Tube OD	6 – 42			
Type of seal	metallic	metallic + soft sealing		
Pressure load capacity	up to 500 bar (series L)			
	up to 800 bar (series S)			
Features	2-cutting-edge cutting ring with block stop	2-cutting-edge cutting ring with stop and additional soft seals	Tube forming solution with soft seals	10° flared coupling

Materials

Material – version	Steel	Steel / stainless steel*	Steel / stainless steel*	Steel
possible material pairing	Steel / stainless steel			Steel / stainless steel**
Soft seal material	–	FPM/FKM (black)	FPM/FKM (green)	NBR (standard) FPM/FKM (green)

Assembly instructions

Machine-assisted pre-assembly	possible	required		
Pre-assembly device	Type 90 Basic II / Comfort	Type 100 /	Type 90 Basic II / Comfort	
	Type 80 N3	Type 100 Compact	Type 80 N3	
Manual pre-assembly	possible	–	–	

Specifications

Installation spaces	Minimum length of straight tube sections $H > 33$ mm (L12) (see catalogue page 382; 392; 397)	Minimum length of straight tube sections (A1-L1) > 53 mm (L12) (see catalogue page 407)	Minimum length of straight tube sections (L1+L2) > 69.5 mm (L12) (see catalogue page 419)
	Machine-assisted pre-assembly only possible to a limited extent if the bend radii are small	Small bend radii are only possible to a limited extent because of pre-assembly device	Small bend radii are only possible to a limited extent because of pre-assembly device
Leak-tightness in relation to influencing factors / assembly	Many influencing factors, reliability depends on correct assembly	Hardly any influencing factors, very high safety factor (process reliability)	Some influencing factors, high safety factor

* Machine-assisted pre-assembly is recommended

** Recommendation: DurNi coated connection parts

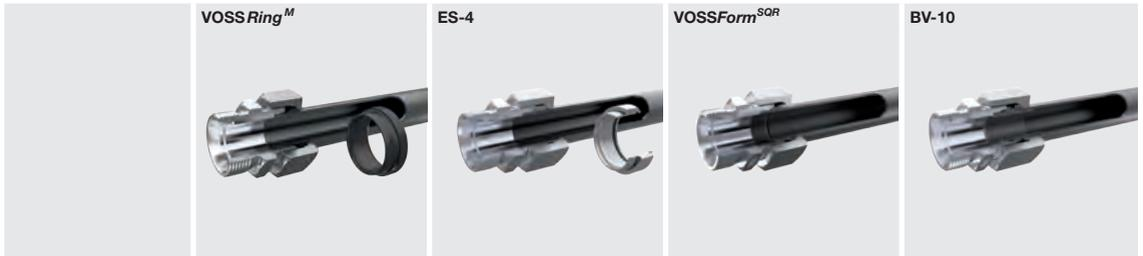

Specifications				
Typical application sectors	Construction machinery, wind turbines, agricultural machinery, Pneumatic brakes, railway engineering	Agricultural machinery, cranes, mobile hydraulic systems	Elevators, presses	Injection-molding machines, mining vehicles
Can be used in safety areas.	No		Yes	
Fitter training requirements	Refresher training at 2-year intervals is recommended		low, single training course required	low, initial training course required, occasional refresher courses recommended
Pressure load capability				
-static/dyn. pressure load capability	very good	very good	excellent	excellent
-Transmission of external forces				
Resistance to tearing out of tubing	good	good	very good	very good
Long-term durability	good	very good	excellent	excellent
Influence of tube preparation	great	great	little	great
Conclusion	Cutting ring for normal applications, also suitable for high pressures	Cutting ring for all applications, high pressures and additional safety against leakage	Tube-forming solution for highest requirements and process stability	Flaring solutions for highest requirements, also ideally suited for repairs

Preventing faults and correcting malfunctions

All VOSS Fluid products have been carefully designed, taking into account ease of assembly, user-friendliness and the product's ability to reliably fulfil the intended purpose.

In order to ensure these qualities while the products are in use, the careful choice of hydraulic coupling systems along with their correct assembly and installation are of tremendous importance.

Almost 85 % of all failures are due to assembly or installation faults, leading to impaired sealing functions or even complete failure of the coupling or connection.

Distribution of causes of assembly faults:

- approx. 55 % too slack assembly for tube OD 20–42 mm.
- approx. 40 % over-tightening for tube OD 6 – 18 mm.
- approx. 5 % other assembly/installation faults

Faulty hydraulic lines not only lead to immense re-working costs and image loss, they can also have serious consequences such as accidents, fire hazards and environmental damage.

On the following pages, you will find system-related notes which will help you identify potential faults causes and take preventive action.

You must on all accounts observe the notes in this catalogue as well as the assembly and operating instructions for VOSS tube connection systems, tools and pre-assembly devices.

In addition, we recommend regular user training and assembly auditing by our qualified staff.



VOSS Ring^M cutting ring couplings



Problem: "leaks"

Characteristic	Preventive measures
Inadequate penetration of cutting ring / not enough tube material raised in front of first cutting edge.	<p>Observe the specified tightening paths (number of turns) when manually pre-assembling the coupling.</p> <ul style="list-style-type: none"> ■ Mark strokes on parts to allow visual control of the rotation angle. ■ Use lubricants to reduce the assembly forces required. <p>Use pre-assembly devices and VOSS tools.</p> <p>Observe the specified pre-assembly device parameter settings</p> <ul style="list-style-type: none"> ■ Inspect and check the pre-assembly devices regularly <p>Select tubes as specified in DIN EN 10305-4.</p> <p>Do not use rotary grinder or tube cutter</p> <p>Only de-burr tube edges internally and externally, do not sharpen them. Check de-burring tool regularly.</p> <p>Cut tubes at right angles.</p> <p>Ensure that the area where the tube was cut is free of contamination, metal chips and paint.</p>
No visibly raised tube material in front of the first cutting edge / cutting ring is jammed on the tube.	<p>The tube must be pushed firmly against the stop in the stud.</p> <ul style="list-style-type: none"> ■ Ensure that the assembly is not subject to stress during installation <p>Use pre-assembly devices and VOSS tools.</p>
Tube has been pressed away from under the cutting ring / the tube bulges	<p>For thin-walled tubes, use suitable reinforcing supports.</p>
Constriction behind the cutting ring / damaged thread / after being slackened, the nut cannot be unscrewed any further by hand / the nut bulges / damage to the hex spanner surfaces	<p>Observe the specified tightening paths when manually assembling the coupling.</p> <ul style="list-style-type: none"> ■ Mark strokes on parts to allow visual control of the rotation angle. ■ Use lubricants to reduce the required assembly forces. <p>Use pre-assembly devices and VOSS tools.</p> <p>Observe the specified pre-assembly device parameter settings</p> <ul style="list-style-type: none"> ■ Inspect and check the pre-assembly devices regularly <p>Select tubes as specified in DIN EN 10305-4.</p> <p>Avoid frequent re-tightening of the coupling after assembly.</p> <p>Avoid using extenders for small tubes and couplings.</p>
Cutting ring is obviously too near the tube end / stud connector has expanded	<p>Inspect and check the pre-assembly devices regularly.</p> <ul style="list-style-type: none"> ■ Use taper gauges. <p>Do not re-use screw coupling parts more than once.</p> <p>Use pre-assembly dies, "high-strength material" version.</p> <p>Use VOSS test gauges to check cutting-ring positions.</p>

VOSS Ring^M cutting ring couplings



Problem: “leaks”

Characteristic	Preventive measures
Damage found on cutting ring after pre-assembly	<p>Inspect and check the pre-assembly devices regularly.</p> <ul style="list-style-type: none"> ■ Inspect internal cone surfaces for damage and/or contamination. <p>Using suitable lubricants increases tool service life.</p>
Cutting ring leaks repeatedly	<p>Select the suitable system for the respective application (depending on temperature, pressure and type of load).</p> <p>Use a soft sealing system (ES-4 / VOSSForm^{SOFT} / BV-10)</p> <p>Avoid duplicate dimension notations; take expansion loops into consideration to permit stress-free installation.</p> <p>Use tube saddles or clamps.</p> <p>Provide specified minimum length of straight tube leading to elbow.</p>
Cutting ring has penetrated unevenly	<p>Provide specified minimum length of straight tube leading to elbow.</p> <p>Select tubes as specified in DIN EN 10305-4.</p>
Slight oil film around the coupling	<p>Only apply a small amount of lubricant to the components during assembly.</p> <p>Degrease the components after assembly.</p>
Components bind at surfaces in contact with one another.	<p>Use suitable stainless-steel assembly paste.</p> <p>Apply sufficient lubricant to the contact surfaces.</p> <p>Only use hardened pre-assembly dies for manual pre-assembly work.</p> <p>Use pre-assembly devices and VOSS tools.</p>



Problem: “tube rupture”

Characteristic	Preventive measures
Tube breaks off directly behind union nut	<p>Use tube saddles or clamps.</p> <p>Ensure that components are not subject to stresses in installed condition, avoid shear loads.</p> <p>Select the most suitable system for the respective application (depending on temperature, pressure and type of load)</p>
Tube breaks off directly behind the cutting ring	<p>Stop tightening as soon as the cutting ring has reached the block.</p> <p>Avoid using extenders for small tubes and couplings.</p>



Problem “tube pulled out of coupling”

Characteristic	Preventive measures
Cutting ring peels material off end of tube due to too shallow incision.	<p>Before every final assembly, check the amount of tube material raised by the first cutting edge.</p> <p>Re-assemble and tighten up cutting-ring couplings which were inadequately tightened.</p>
No visibly raised tube material in front of the first cutting edge / cutting ring is jammed on the tube.	Before every final assembly, check the amount of tube material raised by the first cutting edge.
Cutting ring has been placed on tube the wrong way around	Check that the cutting ring faces the correct direction.

VOSS 2SVA cutting ring couplings



Problem: “leaks”

Characteristic	Preventive measures
Inadequate penetration of cutting ring / not enough tube material raised in front of first cutting edge.	<p>Observe the specified tightening paths (number of turns) when manually pre-assembling the coupling.</p> <ul style="list-style-type: none"> ■ Mark strokes on parts to allow visual control of the rotation angle ■ Use lubricants to reduce the assembly forces required <p>Use pre-assembly devices and VOSS tools</p> <p>Observe the specified pre-assembly device parameter settings</p> <ul style="list-style-type: none"> ■ Inspect and check the pre-assembly devices regularly <p>Select tubes as specified in DIN EN 10305-4</p> <p>Do not use rotary grinder or tube cutter</p> <p>Only de-burr tube edges internally and externally, do not sharpen them. Check de-burring tool regularly.</p> <p>Cut tubes at right angles.</p> <p>Ensure that the area where the tube was cut is free of contamination, metal chips and paint.</p>
No visibly raised tube material in front of the first cutting edge / cutting ring is jammed on the tube.	<p>The tube must be pushed firmly against the stop in the stud.</p> <ul style="list-style-type: none"> ■ Ensure that the assembly is not subject to stress during installation <p>Use pre-assembly devices and VOSS tools</p>
Tube has been pressed away from under the cutting ring / the tube bulges	<p>For thin-walled tubes, use suitable reinforcing supports.</p> <p>Avoid frequent re-tightening of the coupling after assembly.</p>
Too much tube material has been raised	<p>Observe the specified tightening paths when manually assembling the coupling.</p> <ul style="list-style-type: none"> ■ Mark strokes on parts to allow visual control of the rotation angle. ■ Use lubricants to reduce the required assembly forces. <p>Use pre-assembly devices and VOSS tools</p> <p>Observe the specified pre-assembly device parameter settings</p> <ul style="list-style-type: none"> ■ Inspect and check the pre-assembly devices regularly <p>Select tubes as specified in DIN EN 10305-4</p> <p>Avoid using extenders for small tubes and couplings.</p>
Damaged threads / after being slackened, the nut cannot be unscrewed any further by hand.	<p>Observe the specified tightening paths when manually assembling the coupling.</p> <ul style="list-style-type: none"> ■ Mark strokes on parts to allow visual control of the rotation angle. ■ Use lubricants to reduce the required assembly forces. <p>Avoid using extenders for small tubes and couplings.</p>

Characteristic	Preventive measures
The nut bulges / damage to the hex spanner surface	<p>Observe the specified tightening paths when manually assembling the coupling.</p> <ul style="list-style-type: none"> ■ Mark strokes on parts to allow visual control of the rotation angle. ■ Use lubricants to reduce the required assembly forces. <p>Avoid using extenders for small tubes and couplings.</p>
Cutting ring is obviously too near to the tube end / stud connector has expanded	<p>Inspect and check the pre-assembly devices regularly.</p> <ul style="list-style-type: none"> ■ Use taper gauges. <p>Do not re-use screw coupling parts more than once.</p> <p>Use pre-assembly dies, "high-strength material" version.</p> <p>Use VOSS test gauges to check cutting-ring positions.</p>
Damage found on cutting ring after pre-assembly	<p>Inspect and check the pre-assembly devices regularly.</p> <ul style="list-style-type: none"> ■ Inspect internal cone surfaces for damage and/or contamination. <p>Using suitable lubricants increases tool service life.</p>
Cutting ring leaks repeatedly	<p>Select the most suitable system for the respective application (depending on temperatures, pressure and type of load and stress)</p> <p>Use a soft sealing system (ES-4 / VOSSForm^{SQR} / BV-10).</p> <p>Avoid duplicate dimension notations; take expansion loops into consideration to allow stress-free installation.</p> <p>Use tube saddles or clamps.</p> <p>Provide specified minimum length of straight tube leading to elbow.</p>
Cutting ring has penetrated unevenly	<p>Provide specified minimum length of straight tube leading to elbow.</p> <p>Select tubes as specified in DIN EN 10305-4.</p>
Slight oil film around the coupling	<p>Only apply a small amount of lubricant to the components during assembly.</p> <p>Degrease the components after assembly.</p>
Components bind at surfaces in contact with one another.	<p>Use suitable stainless-steel assembly paste.</p> <p>Apply sufficient amount of lubricant to the contact surfaces.</p> <p>Only use hardened pre-assembly dies for manual pre-assembly work.</p> <p>Use pre-assembly devices and VOSS tools.</p>

VOSS 2SVA cutting ring couplings



Problem: “tube rupture”

Characteristic	Preventive measures
Tube breaks off directly behind union nut	Use tube saddles or clamps.
	Ensure that components are not subject to stresses in installed condition, avoid shear loads.
	Select the most suitable system for the respective application (depending on temperature, pressure and type of load)



Problem “tube pulled out of coupling”

Characteristic	Preventive measures
Cutting ring peels material off end of tube due to too shallow incision.	Before each final assembly, check the amount of tube material raised by the first cutting edge.
	Re-assemble and tighten up cutting-ring couplings which were inadequately tightened.
No visibly raised tube material in front of the first cutting edge / cutting ring is jammed on the tube.	Before each final assembly, check the amount of tube material raised by the first cutting edge.
Cutting ring has been placed on tube the wrong way around	Check that the cutting ring faces the correct direction.

VOSS ES-4/ES-4VA cutting ring couplings



Problem: "leaks"

Characteristic	Preventive measures
Inadequate penetration of cutting ring / not enough tube material raised in front of first cutting edge.	<p>Observe the specified tightening paths (number of turns) when manually pre-assembling the coupling.</p> <ul style="list-style-type: none"> ■ Mark strokes on parts to allow visual control of the rotation angle. ■ Use lubricants to reduce the required assembly forces. <p>Use pre-assembly devices and VOSS tools.</p> <p>Observe the specified pre-assembly device parameter settings</p> <ul style="list-style-type: none"> ■ Inspect and check the pre-assembly devices regularly <p>Select tubes as specified in DIN EN 10305-4.</p> <p>Do not use rotary grinder or tube cutter</p> <p>Only de-burr tube edges internally and externally, do not sharpen them. Check de-burring tool regularly.</p> <p>Cut tubes at right angles.</p> <p>Ensure that the area where the tube was cut is free of contamination, metal chips and paint.</p>
No visibly raised tube material in front of the first cutting edge / cutting ring is jammed on the tube.	<p>The tube must be pushed firmly against the stop in the stud.</p> <ul style="list-style-type: none"> ■ Ensure that the assembly is not subject to stress during installation <p>Use pre-assembly devices and VOSS tools.</p>
Tube has been pressed away from under the cutting ring / the tube bulges	<p>For thin-walled tubes, use suitable reinforcing supports.</p> <p>Avoid frequent re-tightening of the coupling after assembly.</p>
Cutting ring is obviously too near to the tube end / stud connector has expanded	<p>Inspect and check the pre-assembly devices regularly.</p> <ul style="list-style-type: none"> ■ Use taper gauges. <p>Do not re-use screw coupling parts repeatedly.</p> <p>Use pre-assembly dies, "high-strength material" version.</p> <p>Use VOSS test gauges to check cutting-ring positions.</p>
Damage found on cutting ring after pre-assembly	<p>Inspect and check the pre-assembly devices regularly.</p> <ul style="list-style-type: none"> ■ Inspect internal cone surfaces for damage and/or contamination. <p>Using suitable lubricants increases tool service life.</p>
Sweating of liquid at tube end	<p>In order to prevent the soft seal from being damaged, it is essential to apply a lubricant to the tube before installing the cutting ring during the pre-assembly process.</p> <p>Deburr the inner and outer edges of the tube end lightly.</p> <p>Check de-burring tool regularly.</p>

Characteristic	Preventive measures
Sweating of liquid at stud connector end	<p>To prevent damage to the soft seals, lubricant must be applied to all soft seals of the cutting- ring before assembling the coupling.</p> <p>Check soft seals for damage before assembling the coupling, replace seals if necessary.</p>
Missing soft seals	<p>Check that all components are in place before assembling the coupling.</p> <p>Replace soft seal.</p>
Cutting ring leaks repeatedly	<p>Select the most suitable system for the application (depending on temperatures, pressure and type of load and stress)</p> <p>Avoid duplicate dimension notations; take expansion loops into account to permit stress-free installation.</p> <p>Use tube saddles or clamps.</p> <p>Observe minimum lengths specified for straight tubes following elbows.</p>
Cutting ring has penetrated unevenly	<p>Provide specified minimum length of straight tube leading to elbow.</p> <p>Select tubes as specified in DIN EN 10305-4.</p>
Very little or no material raised by the first cutting edge	<p>Stainless-steel cutting rings must be used for stainless-steel tubes.</p>
Components bind at surfaces in contact with one another.	<p>Use suitable stainless-steel assembly paste.</p> <p>Apply sufficient amount of lubricant to the contact surfaces.</p> <p>Only use hardened pre-assembly dies for manual pre-assembly work.</p> <p>Use pre-assembly devices and VOSS tools.</p>

VOSS ES-4/ES-4VA cutting ring couplings



Problem: “tube rupture”

Characteristic	Preventive measures
Tube breaks off directly behind union nut	<p>Use tube saddles or clamps.</p> <p>Ensure that components are not subject to stresses in installed condition, avoid shear loads.</p> <p>Select the most suitable system for the application (depending on temperature, pressure and type of load)</p>
Tube breaks off directly behind the cutting ring	<p>Stop tightening as soon as the cutting ring has reached the block.</p> <p>Avoid using extenders for small tubes and couplings.</p>



Problem “tube pulled out of coupling”

Characteristic	Preventive measures
Cutting ring peels material off end of tube due to too shallow incision.	<p>Before every final assembly, check the amount of tube material raised by the first cutting edge.</p> <p>Re-assemble and tighten up cutting-ring couplings which were inadequately tightened.</p>
No visibly raised tube material in front of the first cutting edge / cutting ring is jammed on the tube.	Before every final assembly, check the amount of tube material raised by the first cutting edge.
Cutting ring has been placed on tube the wrong way around	Check that the cutting ring faces in the correct direction.

VOSSForm^{SQR}/VOSSForm^{SQR}VA tube couplings



Problem: “leaks”

Characteristic	Preventive measures
Nut comes loose during operation	<p>Observe the specified tightening paths (number of turns) when finally assembling the coupling.</p> <ul style="list-style-type: none"> ■ Mark strokes on parts to allow visual control of the rotation angle. ■ Use lubricants to reduce the required assembly forces and to reduce soft-seal wear. <p>Observe specified tightening torque where this is the assembly criterion.</p>
No moulded seal	<p>Check that all components are in place before assembling the coupling.</p> <p>Install the soft seal.</p>
No clamping ring in the nut	<p>Check that all components are in place before assembling the coupling.</p> <p>Store DIN union nuts and SQR function nuts separately in order to prevent mistakes.</p> <p>Only use SQR function nuts.</p>
VOSSForm ^{SQR} contour is not created correctly	<p>Check and inspect tools and machines regularly.</p> <p>Check the contour after every forming operation.</p> <p>Apply a thin film of lubricant only to the inner and outer tube surfaces, not to the end face, as oil on the end face can falsify the forming process results.</p> <p>Tube must be pushed against the stop plate during the forming process.</p> <p>Clean tools regularly.</p>
Slight oil film around the coupling	<p>Only apply a small amount of lubricant to the components during assembly.</p> <p>Degrease the components after assembly.</p>
Material surface binds during tube forming / tool breakage	<p>Only stainless-steel tools (marked VA for stainless-steel use) may be used for forming stainless-steel tubes.</p> <p>Use special fine-cutting oil (Feinschneideöl FOE).</p>
Components bind at surfaces in contact with one another.	<p>Use suitable stainless-steel assembly paste.</p> <p>Apply sufficient lubricant to the contact surfaces.</p>
Couplings leak repeatedly	<p>Select the most suitable system for the application (depending on temperature, pressure and type of load and stress)</p>



Problem: “tube rupture”

Characteristic	Preventive measures
Tube breaks off directly behind union nut	<p>Tube breaks off directly behind union nut</p> <p>Ensure that components are not subject to stresses in installed condition, avoid shear loads.</p>

VOSS BV-10 flared couplings



Problem: "leaks"

Characteristic	Preventive measures
Flared cone has not been driven into the tube far enough / saw-toothed surface is not completely covered.	Check that the gap between the face end of the tube and the collar of the cone is correct (≥ 0.5 to max. 1 mm).
Nut comes loose during operation	Observe the specified tightening paths when manually assembling the coupling. <ul style="list-style-type: none"> ■ Mark strokes on parts to allow visual control of the rotation angle. ■ Use lubricants to reduce the assembly forces required and to reduce soft-seal wear.
Tube has bulged in the front section	Check that the gap between the face end of the tube and the collar of the cone is correct (≥ 0.5 to max. 1 mm). The end face of the tube must not come into contact with the collar of the flared cone during the pre-assembly process.
Damaged thread / after being slackened, the nut cannot be unscrewed any further by hand / the nut bulges / damage to the hex spanner surfaces	Observe all specified tightening distances <ul style="list-style-type: none"> ■ Mark strokes on parts to allow visual control of the rotation angle. ■ Use lubricants to reduce the required assembly forces. Select tubes as specified in DIN EN 10305-4. Avoid frequent re-tightening of the coupling after assembly. Avoid using extenders for small tubes and couplings.
Missing O-ring	Check that all components are in place before assembling the coupling. Install the soft seal.
Clamping ring missing	Check that all components are in place before assembling the coupling. Always install clamping ring before flaring the tube.
Slight oil film around the coupling	Only apply a small amount of lubricant to the components during assembly. Degrease the components after assembly.
Contact corrosion during operation	When using stainless-steel tubing, only use Dur-Ni-coated flared cones. Apply sufficient lubricant to the contact surfaces.
Components bind at surfaces in contact with one another.	Use suitable stainless-steel assembly paste. Apply sufficient lubricant to the contact surfaces.
Couplings leak repeatedly	Select the most suitable system for the application (depending on temperature, pressure and type of load and stress)



Problem: “tube rupture”

Characteristic	Preventive measures
Tube breaks off directly behind union nut	Use tube saddles or clamps. Ensure that components are not subject to stresses in installed condition, avoid shear loads.

VOSS ZAKO/ZAKO LP



Problem: “leaks”

Characteristic	Preventive measures
Flared cone has not been driven into the tube far enough / saw-toothed surface is not completely covered	Observe specified gap width between face end of tube and collar of ZAKO ring, see assembly instructions for dimensions.
ZAKO ring lifts off the connecting surface	Tighten all screws/bolts with the specified torques.
Tube has bulged in the front section	Observe specified gap width between face end of tube and collar of ZAKO ring, see assembly instructions for dimensions. The end face of the tube must not come into contact with the collar of the ZAKO ring during the pre-assembly process.
Screws/bolts are difficult to screw into the threaded flange	Lubricate the screw/bolt threads
Missing O-ring	Check that all components are in place before assembling the coupling. Install the soft seal.
Sealing surfaces are dirty	Keep sealing surfaces and soft seals clean.
Flange mounted crookedly on the tube	Ensure that the flange is at right angles to the connecting surface. ■ Tighten up diagonally opposing screw/bolt pairs crosswise.
Slight oil film around the coupling	Degrease the components after assembly.
Couplings leak repeatedly	Select the most suitable system for the application (depending on temperature, pressure and type of load and stress)



Problem: “tube rupture”

Characteristic	Preventive measures
Tube breaks off directly behind the flange	Tube breaks off directly behind union nut Ensure that components are not subject to stresses in installed condition, avoid shear loads.

VOSS taper seal couplings (DKO)



Problem: “leaks”

Characteristic	Preventive measures
Nut comes loose during operation	<p>Observe the specified tightening paths (number of turns) when finally assembling the coupling.</p> <ul style="list-style-type: none"> ■ Mark strokes on parts to allow visual control of the rotation angle. ■ Use lubricants to reduce the required assembly forces. <p>Observe specified tightening torque where this is the assembly criterion.</p>
Damaged thread / after being slackened, the nut cannot be unscrewed any further by hand / the nut bulges / damage to the hex spanner surfaces / wire pin has come out of the groove	<p>Observe the specified tightening paths (number of turns) when finally assembling the coupling.</p> <ul style="list-style-type: none"> ■ Mark strokes on parts to allow visual control of the rotation angle. ■ Use lubricants to reduce the required assembly forces. <p>Avoid using extenders for small tubes and couplings.</p>
Missing O-ring	<p>Check that all components are in place before assembling the coupling.</p> <p>Install the soft seal.</p>
Slight oil film around the coupling	<p>Only apply a small amount of lubricant to the components during assembly.</p> <p>Degrease the components after assembly.</p>
Damaged O-ring	<p>Align DKO coupling properly before tightening it by hand. Hold the connecting piece body with a spanner to counter tightening torque when finally tightening up the connection.</p> <p>Use lubricants to reduce the assembly forces required and to reduce soft-seal wear.</p> <p>Ensure that components are not subject to stresses in installed condition, avoid shear loads.</p>
Couplings leak repeatedly	<p>Select the most suitable system for the application depending on temperature, pressure and type of load and stress)</p>



Problem: “tube rupture”

Characteristic	Preventive measures
DKO coupling cracks open radially along the groove for the wire pin	<p>Install the connected tubes and hoses in such a way that no additional shear loads will act on the coupling.</p> <p>Ensure that the components are not subjected to stresses in the installed state.</p>

VOSS 24° couplings



Problem: “leaks”

Characteristic	Preventive measures
Screwed connection pulls out of the threads	<p>Observe all specified tightening torques</p> <ul style="list-style-type: none"> ■ Use lubricants
Damaged thread / damage to the hex spanner surfaces	<p>Observe all specified tightening torques</p> <ul style="list-style-type: none"> ■ Use lubricants <p>Avoid frequent re-tightening of the coupling after assembly.</p> <p>Avoid using extenders for small tubes and couplings.</p>
Thread tears away	<p>Observe all specified tightening torques</p> <p>Use a spanner to hold the coupling body when assembling the coupling.</p>
Missing seal (PEFLEX or O-ring)	<p>Check that all components are in place before assembling the coupling.</p> <p>Install the soft seal.</p>
Threaded section cannot be screwed into the female part	<p>Check whether the threads are imperial or metric (danger of confusion).</p> <ul style="list-style-type: none"> ■ Use the VOSS thread gauge board to determine the thread type and size.
Leaks in the threads	<p>Keep sealing surfaces and soft seals clean.</p> <p>Use the correct type of seal for every threaded hole.</p> <p>Avoid screwing conical male stud connectors into cylindrical threaded holes.</p> <ul style="list-style-type: none"> ■ Use components with adjustable screw connections as an alternative.
Leakage at recesses	<p>When re-assembling used components, especially male stud connectors with a sealing edge (form B), renew the recess every time.</p> <p>Use the correct type of seal for every threaded hole.</p>
Damaged thread / hairline cracks in the male stud connector	<p>Correct handling and transportation.</p> <p>Inspect and check coupling components before assembly.</p> <p>Check that the DKO cone has a stop to prevent over-tightening of the connection.</p>
Slight oil film around the coupling	<p>Only apply a small amount of lubricant to the components during assembly.</p> <p>Degrease the components after assembly.</p>

Characteristic	Preventive measures
Components bind at surfaces in contact with one another.	Use suitable stainless-steel assembly paste. Apply sufficient lubricant to the contact surfaces.
Male stud connectors cannot be unscrewed manually after being initially slackened	Observe the tightening torques specified for the respective mating materials. Use suitable lubricants.
Metal chips in the threaded hole	Clean the threads.

Services

- Lower process costs
- Reduce throughput times
- Increase process reliability by applying individual logistics solutions

Content Type/Page

Value Added Solutions P.505

Values added by VOSS Fluid P.506

'VOSS-quality' assembly training and audits P.507

Lower costs by C-parts management P.508

Certification and approvals P.509



Value Added Solutions

Corrosion protection specialists

Intelligent logistics systems

Solutions for highest efficiency



The high value which VOSS Fluid products and services add to the customer's own products and systems offer sustained technical and economic advantages. This added value is defined in terms of core skills in the three fields: development and production, long-term corrosion protection, availability and services.

Permanent critical observation of our own processes, ongoing investments and the employment of qualified skilled staff are constantly opening up new improvement potential for our customers.

Values added by VOSS Fluid

Solutions for highest efficiency

... improve the economic advantages wherever tube couplings are used in your company.

The high quality and user-friendliness of VOSS Fluid product solutions ensure sustained leak-tightness at all times with no negative effect on overall system costs.

- High process safety in assembly / installation processes
- Short assembly/installation times / high productivity
- No reworking required
- Permanently leak-tight connections
- Use of optimum components and systems
- **Improved product quality**
- **Reduction of production costs**

Corrosion protection specialists

... protect your machinery and plants against corrosion for their entire service life!

Corrosion protection by VOSS coat as a standard feature, and VOSS's own electroplating plant ensure sustained process reliability and stability.

- Best available corrosion protection in hydraulic connection engineering
- System selection assistance
- Optimum matching of VOSS components, allowing ease of assembly and installation
- In-house electroplating processes optimized to avoid thread damage
- Constant further development of surface treatments to reduce corrosion and increase ease of assembly
- **Optimization of your corrosion protection measures**
- **Improved customer satisfaction**

Intelligent logistics systems

... provide intelligent logistics, specially tailored to your needs!

Maximum possible regional availability and wide range of services optimize the supply chain at the customer's end.

- Delivery service performance level > 99 %
- Reduction of your stock volumes and re-stocking times
- No special materials management needed
- Complete support for introduction of KANBAN
- Analysis and documentation of consumption
- Web-KANBAN for online monitoring of your entire fluid coupling logistics
- **Simplification / automation of your supply chain**
- **Reduction of your material management costs**

Maintain safety through adequate training

'VOSS-quality' assembly training and audits



Leakages are the worst enemy of hydraulic systems. There are many potential causes of faults, but human error is usually the key factor. Only highly-qualified staff can detect error potential at an early stage and thus avoid errors. VOSS offers regular training courses, both at our Wipperfurth facilities and at the customer's own premises, anywhere in the world. In our assembly audits, we watch your staff at work, analyze processes, inspect assembly workplaces and equipment and then work out tailor-made training measures to enhance your company's sustainable productivity. Less faults, faster results, lower costs.

- Assembly training courses to qualify staff, including both theory and practical training
- Assembly audits for process safety and reliability: inspection of all assembly processes, including checking pre-assembly devices and tools on site

Lower costs by C-parts management

Savings potential

Only a fraction of the costs of hydraulic coupling components are caused by the actual product.

Logistics make up a disproportionately high share of the costs, since these components belong to the C-parts range. However, if any of these components is missing, the assembly process is disrupted just as much as if an A-part is missing.

C-parts management

“VOSS Fluid” is aware of its customers’ specific needs and has logistics systems and solutions in place which save process costs, reduce throughput times and ensure high process reliability. The key to this solution is called “individuality”.

In cooperation with the customer, VOSS develops and implements logistics solutions based on the individual application case. The following examples show how VOSS Fluid has rationalized logistics processes by the use of C-part management.

- Card Kanban
- 2-bin Kanban
- Web KANBAN
- Kit service
- Immediate service
- EDI

Further information upon request.

Total costs “Hydraulic connection”		
Product	Price	15–25 %
Logistics	Identification of needs	
	Purchasing administration	
	Incoming goods receipt	
	Packaging and disposal	
	Quality management and testing costs	
	Warehousing and logistics	
	Inventory costs	
	Transportation	
	Assembly line supply	
	Down-time costs	75–85 %
Total		100 %

Certification and approvals

VOSS Fluid has been certified by TÜV Rheinland in accordance with DIN EN ISO 9001 and DIN EN ISO 14001.

The most common VOSS tube couplings are approved by all major certification companies.

- Germanischer Lloyd
- Det Norske Veritas
- Lloyds Register of Shipping
- Bureau Veritas
- American Bureau of Shipping
- US Coast Guard
- ABS
- Russian Maritime Register of Shipping
- DVGW
- Deutsche Bundeswehr (German armed forces)
- Technical committee "Maschinenbau, Hebezeuge, Hütten- und Walzwerksanlagen" (MHHW) of the HVBG-BGZ [umbrella organization of German trade associations]
- TSSA

We are happy to inform you of further certifications upon request.

Approvals for gas applications in accordance with DVGW*

The following VOSS Fluid tube couplings have been approved by the DVGW for gas applications (gas transport, plant construction, natural gas filling stations, gas-fuelled vehicles, liquid gas systems):

- VOSS 2S cutting ring couplings
- VOSS ES-4 cutting ring couplings
- VOSSForm^{SQR} tube couplings

* DVGW – German Association of Gas and Water Engineers

Gases approved in accordance with DVGW-Arbeitsblatt (DVGW Code of practice) G 260:

- compressed air
- natural gas
- liquid petroleum gas

(Generally, all combustible gases supplied by public gas supply utilities in Germany are approved).

Operating pressure:

A maximum operating pressure (MOP) of up to 250 bar is permitted for the heavy-duty coupling series.

A MOP of 250 bar is permitted for couplings of the light-weight series with tubes of outer diameters up to 18 mm. For tube outer diameters of 22 mm and more, the MOP is limited to 160 bar.

Operating temperature:

Between - 20 °C and +60 °C

Attention!

Approvals have been obtained for specific products and models, applications and operating conditions. Since approvals are only granted for a specific limited period, VOSS renews these as soon as they are due to expire. Detailed information is given in the respective approval certificate.

Please request the up-to-date versions of approval certificates from us. We are happy to advise you on all matters concerning certification and approvals.

VOSS

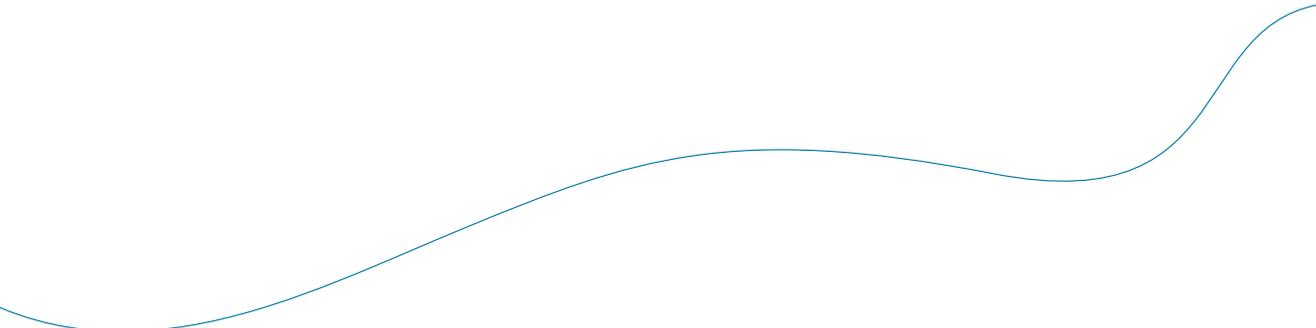

VOSS Fluid GmbH
P.O. Box 15 40
51679 Wipperfürth

Lüdenscheider Straße 52–54
51688 Wipperfürth
Germany

Tel.: +49 2267 63-0
Fax: +49 2267 63-5621
+49 2267 63-5622
+49 2267 63-5623

fluid@voss.net
www.voss.net